

**INTERNATIONAL
eMV™ SERIES**



THE INTERNATIONAL® eMV™ SERIES.





MV
INTERNATIONAL



**SMART.
ADAPTABLE.
REVOLUTIONARY.**



WELCOME TO A NEW ERA OF EFFICIENCY.

The electric truck is here. It's making deliveries, it's hauling materials, it's keeping produce cool, and it's doing all of these jobs on the same proven foundation as the diesel International® MV™ Series – it just happens to be electric. Easy to use, comfortable to operate and offering iron-clad dependability, the new International® eMV™ Series is a groundbreaking solution with real-world usability. It's the electric truck – built just right.



THE TRUCK YOU KNOW AND LOVE...

The The International® MV™ Series has long been the go-to truck for those who need to get work done. Its durability, adaptability and functionality has made it a common sight on roads and worksites everywhere.

The The International® eMV™ Series brings even more to the table thanks to an electric powertrain with new capabilities, new savings and, most importantly, new opportunities.



Bucket Lift



Dump



Flatbed

ELECTRIFIED.



Reefer

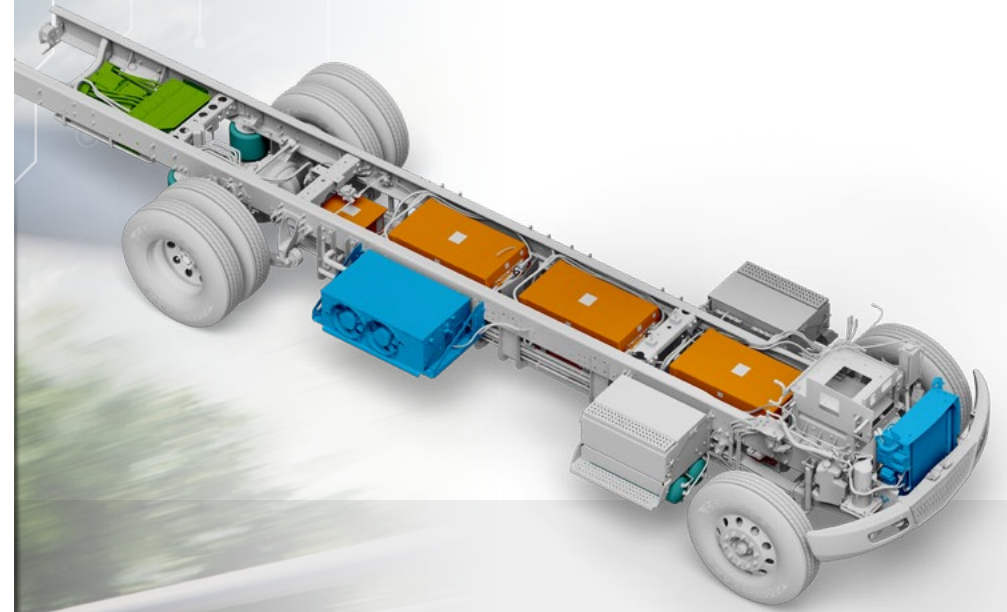

eMV™ Series Key Features:

- ▶ Typical range: *135 miles
- ▶ Peak power: 342hp (**210 kWh Lithium Iron Phosphate (LFP) batteries)
- ▶ 3 levels of regenerative braking
- ▶ Acceleration equal to or better than diesel
- ▶ Battery Thermal Management System (BTMS) using standard red coolant
- ▶ Lower maintenance compared to diesel
- ▶ Available turn-key eMobility charging solutions

*Actual range is based on environmental conditions, driving behaviors, diminishing loads and maximum use of regenerative braking, etc.

**Useable capacity is approx. 189 kWh. Actual range is based on environmental conditions, driving behaviors, etc.



FACTORY-INSTALLED INTERNATIONAL[®] EMV[™] SERIES BODY POWER OPTIONS



The International[®] eMV[™] Series truck now offers ePower and ePTO options that use the propulsive batteries to power a wide range of body applications. From a simple plug in, to an electric motor SAE-B flange, you now have the muscle needed to get the job done.

ePTO

The factory-installed ePTO is ready to power your boom, crane, bucket and more. Quite, electric power offers a variety of benefits including the ability of operators in the bucket to easily communicate with those on the ground.



ePOWER

The power from the propulsive battery can be utilized to operate energy-intensive body applications like refrigeration. Now, food and other perishables can be delivered locally in an emission-free manner.



ePTO ELECTRICAL SYSTEM

- ▶ High Voltage - *210 kWh Lithium Iron Phosphate batteries with dedicated HVAC system
- ▶ 609 Volt operating Voltage
- ▶ Amphenol Powerlok Gen2
- ▶ Typical applications:
 - Utility
 - Dump

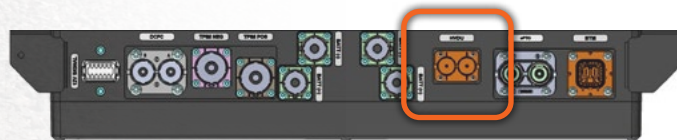

Single Connector

ePOWER ELECTRICAL SYSTEM

- ▶ High Voltage - *210 kWh Lithium Iron Phosphate batteries with dedicated HVAC system
- ▶ 609 Volt operating Voltage
- ▶ 19 kW x2 Connections
 - TE HVA280 Connectors
- ▶ Typical applications:
 - Refrigerator
 - Shredder

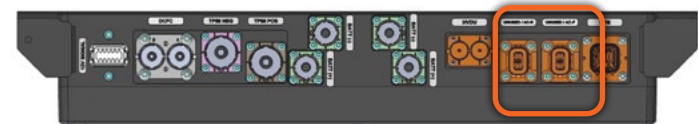

Dual Connections

*Useable capacity is approx. 189 kWh. Actual range is based on environmental conditions, driving behaviors, etc.



STEEL SANCTUARY.

FOR STRENGTH, SAFETY AND COMFORT

The eMV™ Series cab wraps your crew in a high-strength, low-alloy (HSLA) reinforced, cold-rolled steel construction that combines the corrosion resistance of aluminum with the world-class fit, finish and strength of steel. The result is a larger, quieter, more protective interior with air- and water-tight seals.

INTERCOAT® CHEMGUARD

Think of it as a self-healing layer of skin on our galvanized steel. This inter-reactive, chrome-zinc phosphate coating is used on floor and toe kick panels to help extend integrity. The self-rejuvenating properties allow surface cuts, scratches and perforations to maintain corrosion protection.

OPTIONAL SPRAY ON LINER FLOOR PROTECTION

This available polyurethane and polyurea formulation creates a protective tray on the cab floor that contains spills, as well as any of nature's elements that make their way inside. Durable and long-lasting, optional spray on liner coating is an OEM-grade protective coating designed to guard against abrasion, corrosion and impact and can be found on over 4 million pickup bedliners.



CHEMGUARD
COATING

OPTIONAL SPRAY ON
LINER COATING

REINFORCED
B-PILLARS



TOP-DOWN STRENGTH

All eMV™ Series configurations (regular, crew and extended cab) pass the rigorous SAE J2422 roof strength test and Huck Bolt chassis fasteners provide extra clamping force without the need to re-torque, so they won't come loose even under high stress loads.

ANTI-CORROSION THAT'S ANTI-COMPROMISE

At International Truck, longevity is the head of the hammer. Which is why every welded eMV™ Series cab assembly is dipped into an electrostatically-applied primer as part of a rigorous paint, sealing and coating process that provides superior corrosion and fade resistance – all backed by a 5-year perforation corrosion warranty.

CORROSION PROTECTION PROCESS:

1. Stamped steel with 60G/60G dual sided galvanized coating - standard on dash and toe and floor panels
2. Custom-engineered caustic and surfactant formula cleans and preps the steel
3. Proprietary tri-metal (nickel, zinc, manganese) phosphate blend provides robust corrosion protection and the first level of paint adhesion
4. Epoxy-based electrodeposition primer, or E-Coat is applied. This covers and seals the entire exposed metal surface of the cab
5. Acrylic basecoat
6. Urethane clearcoat

E-Coat Paint Process

CLEARCOAT

BASECOAT

E-COAT

GALVANIZED
STEEL

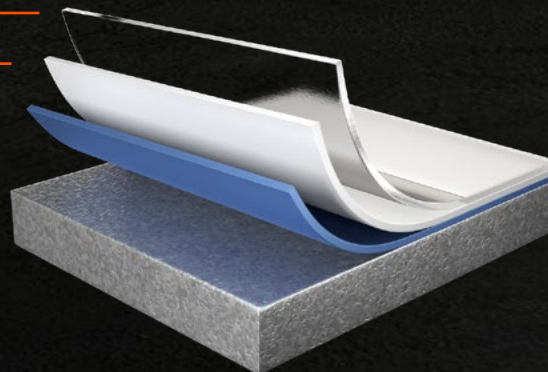

eMV™ Series Features:

- ▶ A high-strength, low-alloy (HSLA) reinforced, cold-rolled steel cab delivers superior corrosion resistance as well as world-class fit and finish
- ▶ The welded cab assembly is dipped into an electrostatically-applied primer as part of a paint process that provides outstanding resistance to corrosion and fading, and it's backed by a 5-year perforation corrosion warranty







A FAMILIAR ENVIRONMENT – NO LEARNING CURVE REQUIRED.

Comfort. Visibility. Safety. It's everything you know and love about the MV™ Series interior, which means you'll be right at home with the eMV™ Series from the get-go. Inside you will find a powerful HVAC system, controls and switches that are easy to find, reach and operate — even when wearing gloves. A sloped hood provides enhanced visibility, and door-mounted mirrors have been expertly positioned for more visibility which requires less head movement by the driver. Even the air horn lanyard is placed exactly where drivers told us it should be.



Every detail inside the eMV™ Series cab has been researched, designed and extensively tested working with the real experts – drivers and body companies that need to deliver on the road or on the jobsite. The final result is a true collaboration of those who know what it takes to be productive and successful.

SMART PRODUCTIVITY. UNDERFOOT AND AT YOUR FINGERTIPS.

CAB FEATURES

CLASSIC

DIAMOND

CAB FEATURES	CLASSIC	DIAMOND
Cab Trim Panels	Easy to clean plastic	Easy to clean plastic
Door Trim	Single piece door panel with integrated door pocket	Single piece door panel with integrated door pocket
Trim Inserts	Neutral	Mineral Teak
Instrument Panel	Black	Black
Gauge Cluster	New digital full color cluster	New digital full color cluster
Accent Color	Neutral	Dark Neutral
Sun Visors	Two	Three
Lighting	LED	LED
Window Controls	Power	Power
Lock Controls	Manual or Power	Power
Cup / Bottle Holders	Four	Four
Overhead Console	Molded Plastic with Retainer Nets and CB Radio Housing	Molded Plastic with Retainer Nets and CB Radio Housing
USB Accessory Port	Up to 5 Available	Up to 5 Available

- 1 The steering wheel adds more functions at the driver's fingertips with integrated back-lit, laser etched labeling for improved durability and visibility. Plus, all the controls within the cab are designed to be operated easily while wearing gloves.
- 2 A standard flat instrument panel includes a center-mounted vent to keep the middle passenger comfortable while providing space for extra legroom or a large floor-mounted body control module.
- 3 Switch panel comes standard with 3-level regenerative braking, off-road traction control, suspension dump and lift gate.
 - ▶ Large, easy-to-read backlit text
 - ▶ Warning lights can be any of seven colors
 - ▶ Blank "windows" available for custom labeling by the customer



SITUATIONAL AWARENESS. ELEVATED.

Uptime is much more than simply being able to work - it also requires giving drivers the tools they need to be seriously productive. It's why the eMV™ Series instrument cluster has. has all the information drivers need, presented in a familiar and intuitive layout.

THE GOAL? IMMEDIATE RECOGNITION. LESS DISTRACTION. AND MORE DRIVER ALERTNESS AND CONFIDENCE.

Power vs Regen
Indicates how much power is being used by the motor when accelerating or how much power is being returned to the batteries during regenerative braking

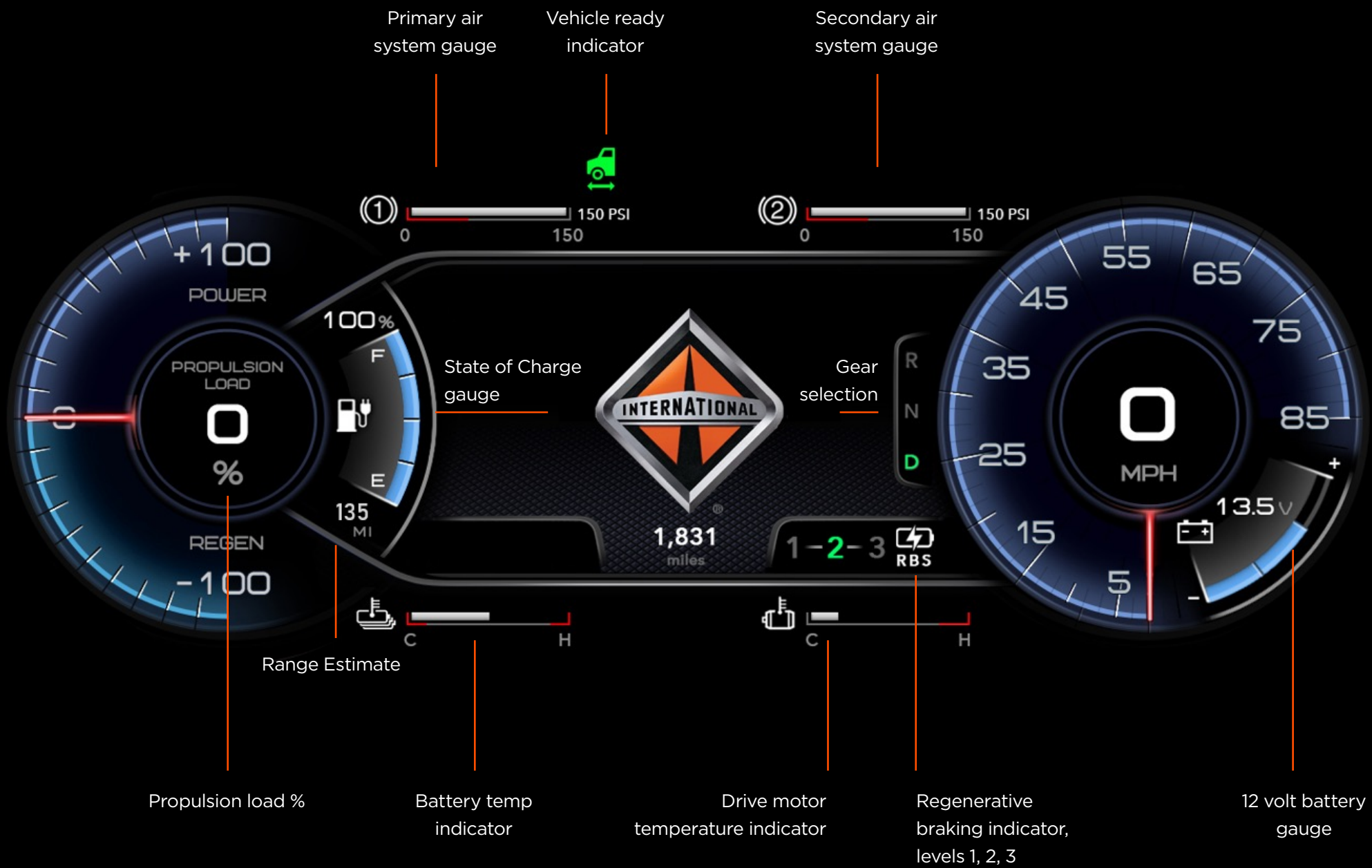

Primary air system gauge

Vehicle ready indicator

Secondary air system gauge

① 0 150 150 PSI

② 0 150 150 PSI

+100
POWER

PROPULSION LOAD
0
%

REGEN
-100

100%
F
E
135 MI

State of Charge gauge



1,831 miles

Gear selection

R
N
D

55 65 75 85
0
MPH

13.5V
+
-

Range Estimate
C H

C H

Propulsion load %

Battery temp indicator

Drive motor temperature indicator

Regenerative braking indicator, levels 1, 2, 3

12 volt battery gauge



STAY THE COURSE

Not every trip goes as planned – and not every other driver on the road is paying attention. That’s why the International® eMV™ Series is equipped with safety systems designed to help keep your drivers (and your equipment) out of harm’s way.

LED HEADLIGHTS

Optional LED highlights offer unparalleled nighttime visibility for improved safety whether you’re inside the cab or out.

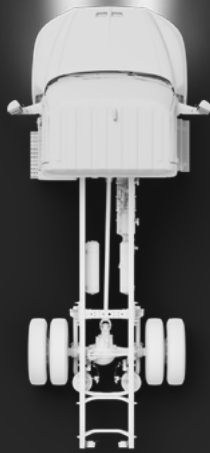

ANTI-LOCK BRAKING SYSTEMS (ABS)

Anti-Lock Braking Systems (ABS) help prevent the wheels from locking up during hard braking events. The system works by rapidly activating the brakes so the driver can still steer and maintain control of the truck while slowing down. This helps the driver avoid skidding, especially in slippery conditions like rain or snow. Most eMV™ Series non-emergency braking is accomplished through regenerative braking. This process uses the motor to slow the vehicle and directs the recaptured energy to the main battery which helps to extend the overall range of the truck.

ELECTRONIC STABILITY CONTROL (ESC)

Bendix® Electronic Stability Control (ESC) technology is a full stability system, offering both roll and yaw stability to potentially help mitigate loss of control and/or rollover. This ABS-based system can potentially recognize and assist in both understeer and oversteer loss-of-control driving events. This advanced feature is particularly helpful in adverse weather conditions, including snow, ice, rain, dust, sand, and more.

AUTOMATIC TRACTION CONTROL (ATC)

Automatic Traction Control (ATC) can regulate wheel spin during acceleration to help improve traction in various conditions. The ATC system will intervene automatically at lower speeds by applying braking pressure to a spinning wheel and transferring engine power to other drive wheels that have better traction. This feature is especially useful at jobsites where road conditions may include dirt, gravel, sand, or ice.

JOBSITE MANEUVERABILITY

The eMV™ Series can easily navigate tight city streets or construction sites, saving driver time, reducing work-site collisions and boosting productivity.



GETTING YOU READY TO MAKE THE SWITCH.

THE ELECTRIC VEHICLE (EV) ROADMAP: YOUR PARTNER FOR A SEAMLESS TRANSITION.

Our dealers and trusted advisors are always available to help you move forward with electrification.

All it takes are three easy steps:

Step 1 | Consulting



FIND THE BEST WAY FORWARD

Our discovery workshops dive into your fleet's electrification needs and concerns, building a customized EV roadmap for success.

Step 2 | Charging

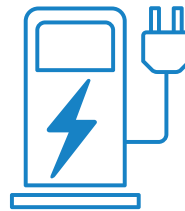

LAY THE GROUNDWORK

We assess the placement of hardware and infrastructure, finding the best ways to support your vehicle charging and uptime.

Step 3 | Deployment

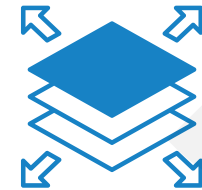

BRING IT ALL TOGETHER

We ensure your charging locations, staff, and remote diagnostics are prepared for your electric vehicle to hit the road.

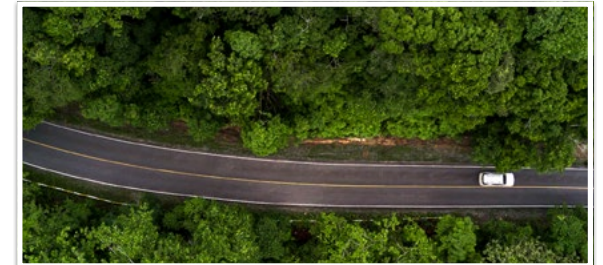



STEP 1: CONSULTING

The International® Truck trusted advisors team will set up your EV roadmap by identifying your short term, and long-term goals, understand your current electric plan and what upgrades may need to be completed. The team will provide end-to-end support and be your single point of contact throughout the entire process.

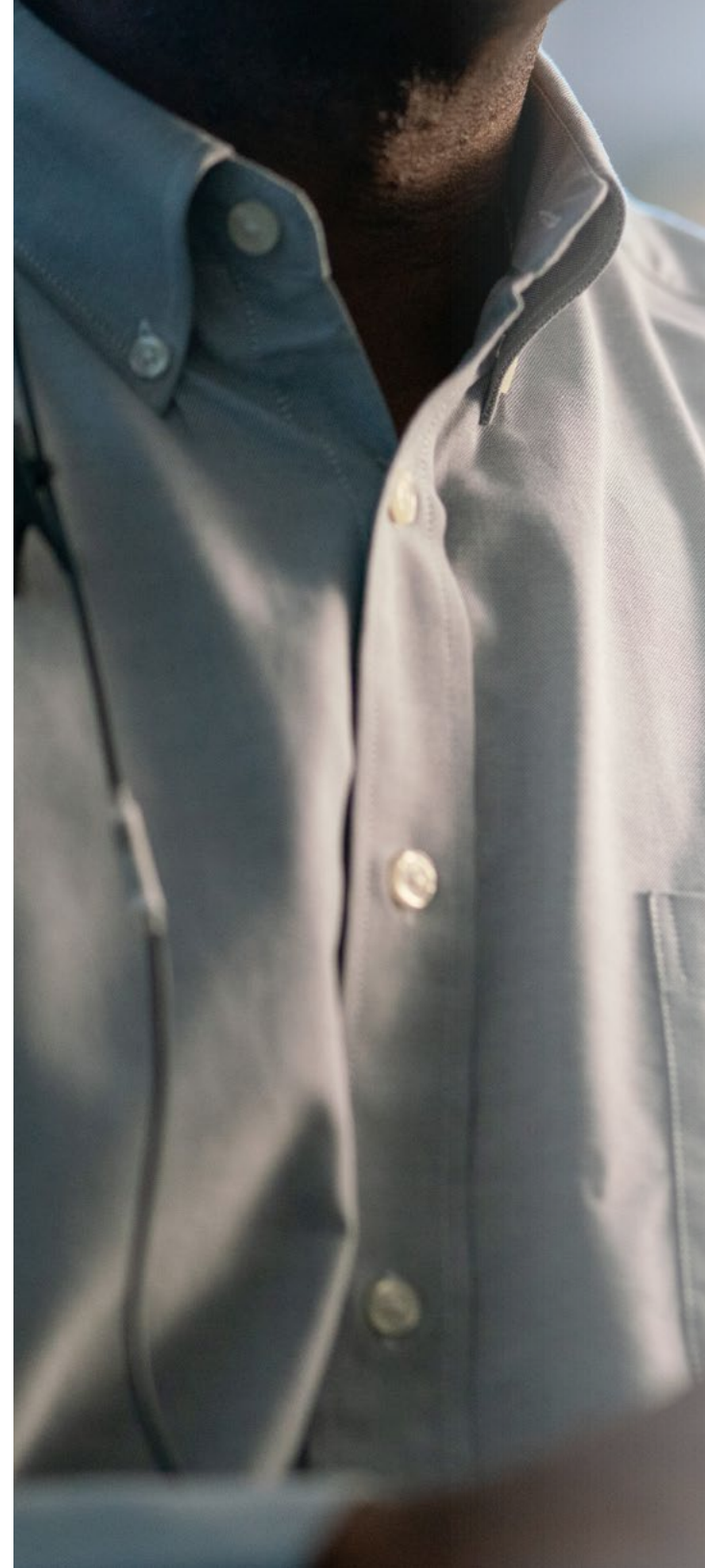

STRATEGY AND SCALABILITY

- ▶ Route Simulations
- ▶ Conduct TCO calculations to understand the costs (and cost-savings) involved with deploying EVs
- ▶ Assistance with federal and state rebates, grants, funding incentives and tax incentives
- ▶ Determine how and when to electrify fleet

SITE SELECTION AND ASSESSMENT

- ▶ Identify and prioritize target sites
- ▶ Perform due diligence on sites
- ▶ Review zoning, power capacity, space; analyze existing power sources

INFRASTRUCTURE CONCEPT DEVELOPMENT

- ▶ Determine the type and level of EV charging equipment
- ▶ Determine vehicles per location; verify charger output requirements; calculate future fleet growth



Scan me!

For more information or to contact our trusted advisors team, scan the QR code.

KEY LOCATIONS

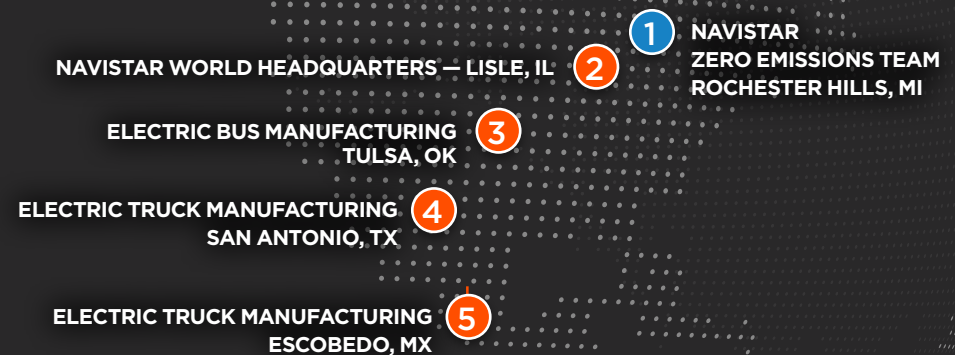

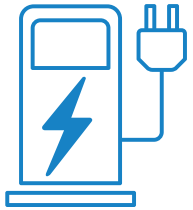

STEP 2: CHARGING

Building out a charging solution that's appropriate for today but flexible enough to grow as you grow, can be a complicated process. We're here to make that process as smooth as possible by working side-by-side through site planning and engineering, AC and DC charger installation, site management, equipment certification and financing for both vehicles and infrastructure.



LEVEL 2 - 19.2 KW AC CHARGER

This AC Level 2 Charger Solution can be used for fleet operations that have longer charge times and is also recommended for diagnostic activities or overnight charging. It is very compact, and can be installed in most fleet garages or bays.



SPECIFICATIONS

- ▶ Max Power Output: 19.2 kW
- ▶ Max Current Output: 80A @ 240Vac
- ▶ Cable Options: SAE J1772 Connector
- ▶ Facility Power Requirements (Volts): 208 / 240V Single Phase
- ▶ Facility Power Requirements (Amps)*: 100



KEY BENEFITS & FEATURES

- ▶ Estimated Charge Time — 189 kWh useable battery capacity - 12 hours**
- ▶ Case Enclosure rated for outdoor use
- ▶ Compact and easy to install

* Per Charger

**20% to 100% state of charge, room temperature current production CATL LFP Batteries

ICE 30 KW DC FAST CHARGER

The 30 kW is a compact DCFC capable of charging with one or two connectors. This DC Wallbox is designed for easy wall-mounting or can be attached to a pedestal. This 30 kW charger is easy to operate with an intuitive touchscreen display and is ideal for fleet charging, as well as a variety of parking applications where shorter charge times are necessary.



SPECIFICATIONS

- ▶ Max Power Output: 30 kW
- ▶ Output Voltage Range: 150 to 1000Vdc
- ▶ Cable Options: CCS1 Connector - Option of 16ft or 25ft cables (recommended)
- ▶ Facility Power Requirements (Volts): 480V 3 Phase
- ▶ Facility Power Requirements (Amps)*: 50



KEY BENEFITS & FEATURES

- ▶ Estimated Charge Time — 189 kWh useable battery capacity - 6 hours**
- ▶ User-friendly control interface allows for access management via PIN or RFID accessibility
- ▶ OCPP 1.6 standard supports interoperability across back end platforms
- ▶ LTE Modem and LAN
- ▶ TUV certification to UL 2202 to ensure safety
- ▶ 480V 3-phase input for high-efficiency conversion
- ▶ DIN 70212 and ISO 15118-2 protocol supported
- ▶ Hot galvanized steel, plastic facade, and tempered glass screen construction ensures longevity

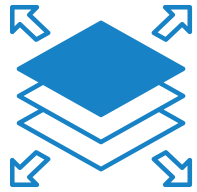

STEP 3: DEPLOYMENT

International Truck has a dedicated team to ensure that your site is ready the moment your eMV™ Series arrives. This Deployment Team works closely with all parties, including your dealer, to ensure that your infrastructure is commissioned, the vehicle arrives on time, and your staff is trained and ready to begin using your electric vehicle immediately.





DELIVERY

- ▶ Confirm operability per specs
- ▶ Verify install and commissioning of equipment
- ▶ Set up remote monitoring & scheduled charging
- ▶ Deliver charge management strategy for future growth

TRAINING

- ▶ Provide training on equipment usage and safety requirements
- ▶ Confirm vehicle readiness and provide training on advance remoted diagnostics
- ▶ Establish routine maintenance schedule
- ▶ Vehicle operation, driver training, charging operation, technician training (maintenance and inspection), storage best practices, towing, first responder training, OnCommand® Connection and any applicable charging software

CONNECTED VEHICLE

- ▶ Confirm connectivity for ongoing maintenance and monitoring

POST DEPLOYMENT PROCESS

- ▶ Reports that compare assumptions of performance and driving efficiency to actual data
- ▶ Guidance to improve efficiency and range
- ▶ Available to answer any questions about the vehicle or charging infrastructure



CRITICAL VEHICLE HEALTH DATA AT YOUR FINGERTIPS

OnCommand® Connection Advanced Remote Diagnostics transforms raw vehicle data into actionable insights to help you stay in front of potential vehicle issues and keep your eMV® Series at peak performance.



FEATURES INCLUDE:

- Reports on vehicle health issues that include severity ratings, likely needed parts and service, and recommended actions
- Comprehensive vehicle health reports that include performance data, fault history, and more
- Up-to-date GPS location with customizable geofencing reports that can help ensure vehicles are where they need to be
- Insights delivered how you need it — via our online portal, your email inbox, a mobile app, and more.

OCC Go Screen

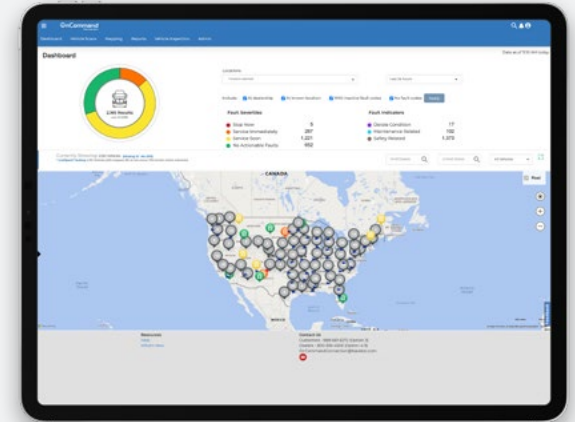
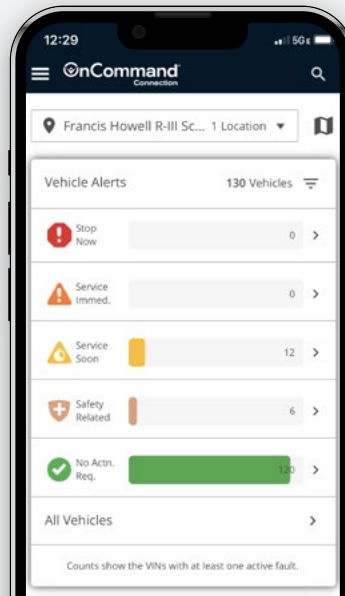

TAKE YOUR PERFORMANCE TO THE NEXT LEVEL

We offer additional tools powered by OnCommand® Connection designed to give your business and operations that extra edge.

OTA Programming

Ensure peak performance with remote software calibration updates to the S13 Integrated Powertrain, anytime, anywhere

TRANSPARENT SERVICE COMMUNICATIONS WITH YOUR DEALER

Knowing when your vehicle's service and repair events will be complete is critical to keeping your business up and running. International® 360 makes the entire process faster and easier to manage.

- Updates via text and email keep you informed on the status of vehicles in service, including estimated time of completion
- Integrates telematics, dealer parts inventory, and other vital information into one easy-to-use tool
- Centralizes vehicle health data, service history, and more



New International® eMV® Series models come standard equipped with factory-installed telematics and five years of service, including:

- **OnCommand® Connection Advanced Remote Diagnostics**
- **International® 360**
- **Intelligent Fleet Care**
 - Fleet Health Monitoring
 - Advanced Preventive Maintenance
 - Advanced Fuel Analytics
 - TPMS Integration (requires TPMS system installed on truck)
 - Gateway Integrations



WHEN COMBINED, THESE SOLUTIONS CAN HELP FLEETS SAVE UP TO \$7,000 OR MORE OVER FIVE YEARS*

*depending on annual miles driven and other operational conditions



eMV Series SPECIFICATIONS

KEY eMV SERIES FEATURES

- ▶ Electrified powertrain - fully integrated ensuring all components are optimized to work with each other as a system
- ▶ *210 kWh Lithium Iron Phosphate (LFP) batteries - fully enclosed inside frame rails
- ▶ Best-in-class regenerative braking on/off with three levels: 30%, 60% and 100%- maximizes driver control
 - Improved vehicle efficiency
 - Increases vehicle range
 - "One" pedal style driving capability, except for a complete stop
- ▶ State of the art driver display
 - Propulsion & regenerative load
 - State of charge indicator
 - Regenerative braking indicator
- ▶ Charging
 - SAE J1772 CCS1 AC/DC charging standard - ensures charging compatibility with most public chargers
 - Up to 125 kW/hour capable with a DC charger
 - OCC standard for 5 years with enhanced eMobility features

FEATURE

AVAILABILITY

Wheelbases / A.F. (Dry Van)

217"/100" typical (20' body): Flat bed, dump, utility
 236"/100" typical (22' body): eTRU, dry van
 254"/100' typical (24' body) eTRU, dry van
 272"/112" typical (26' body): Dry van

12V Liftgate Power Provision

Available

GVWR

25,999 and 33,000 lbs.

Interior

Flat Instrument Panel

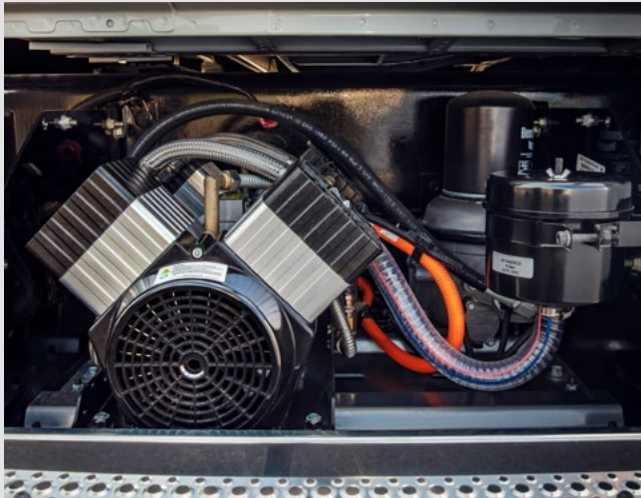

GVWR

- ▶ 25,999 and 33,000 lbs.

Models/BBC/BA

- ▶ MV60E
- ▶ 107.9" BBC, 40" BA

Cab Configurations

- ▶ Day Cab

Wheelbase Options

- ▶ 217", 236", 254" & 272"

Axle Configurations

- ▶ 4x2

Rear Axle

- ▶ Single Rear Axle (4x2)
 - Dana Spicer 23,000 lb.

Rear Suspension

- ▶ 21,000 lb single axle with shocks
- ▶ IROS Air Suspension

Front Axle

- ▶ Dana Spicer I-Beam 12,000 lb.

Front Suspension

- ▶ Spring, Parabolic Taper Leaf: 12,000 lbs.

Frames

- ▶ Heat Treated Alloy Steel 120,000 PSI

Electrical System

- ▶ High Voltage - *210 kWh Lithium Iron Phosphate batteries with dedicated HVAC system
- ▶ 609 volt operating voltage
- ▶ LED Headlights

Brakes

- ▶ Air Brakes with ABS, 4 channel Electronic Stability Program with Traction Control

Steering

- ▶ TRW/Ross Power

Motor

- ▶ Direct Drive Electric Motor
- ▶ Peak Motor Torque: 1737 lbf-ft
- ▶ Continuous Motor Torque: 730 lbf-ft

Tires

- ▶ Continental

RAR (Rear Axle Ratio)

- ▶ 6.83

ePOWER ELECTRICAL SYSTEM

- ▶ High Voltage - *210 kWh Lithium Iron Phosphate batteries with dedicated HVAC system
- ▶ 609 Volt operating Voltage
- ▶ 19 kW x2 Connections
- ▶ TE HVA280 Connectors
- ▶ Typical applications:
 - Refrigerator
 - Shredder

ePTO ELECTRICAL SYSTEM

- ▶ High Voltage - *210 kWh Lithium Iron Phosphate batteries with dedicated HVAC system
- ▶ 609 Volt operating Voltage
- ▶ Amphenol Powerlok Gen2
- ▶ Typical applications:
 - Utility
 - Dump

ePTO MECHANICAL SYSTEM

- ▶ 40 kW¹ Minimum Continuous Power Operation
- ▶ 60 kW Maximum Peak Power Operation

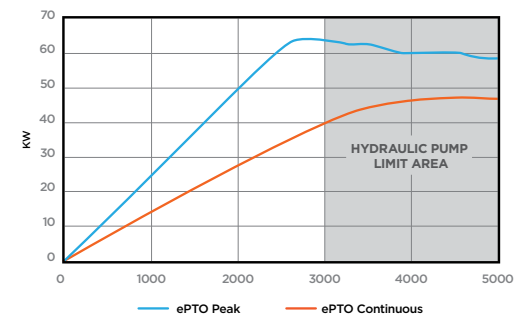

*Useable capacity is approx. 189 kWh. Actual range is based on environmental conditions, driving behaviors, etc.



MAINTENANCE SCHEDULE

It's no secret electric vehicles require less maintenance. With substantially fewer parts, an electric motor simply does not have the maintenance or service requirements of an internal combustion engine. Plus, thanks to regenerative braking, the standard brakes last much longer between service intervals.

TAKE THESE OFF YOUR SERVICE PLATE

- ▶ No engine oil maintenance
- ▶ No transmission maintenance
- ▶ No fuel filters
- ▶ No turbos, no EGR, no Injectors
- ▶ No engine air filters, no MAF and no O2 sensor
- ▶ No aftertreatment

Vehicle Coverage	Years	Miles
Chassis Warranty	2 Years	Unlimited
Drive Battery	5 Years	100,000
Drive Motor	5 Years	100,000
Drive Charger & Cables	5 Years	100,000

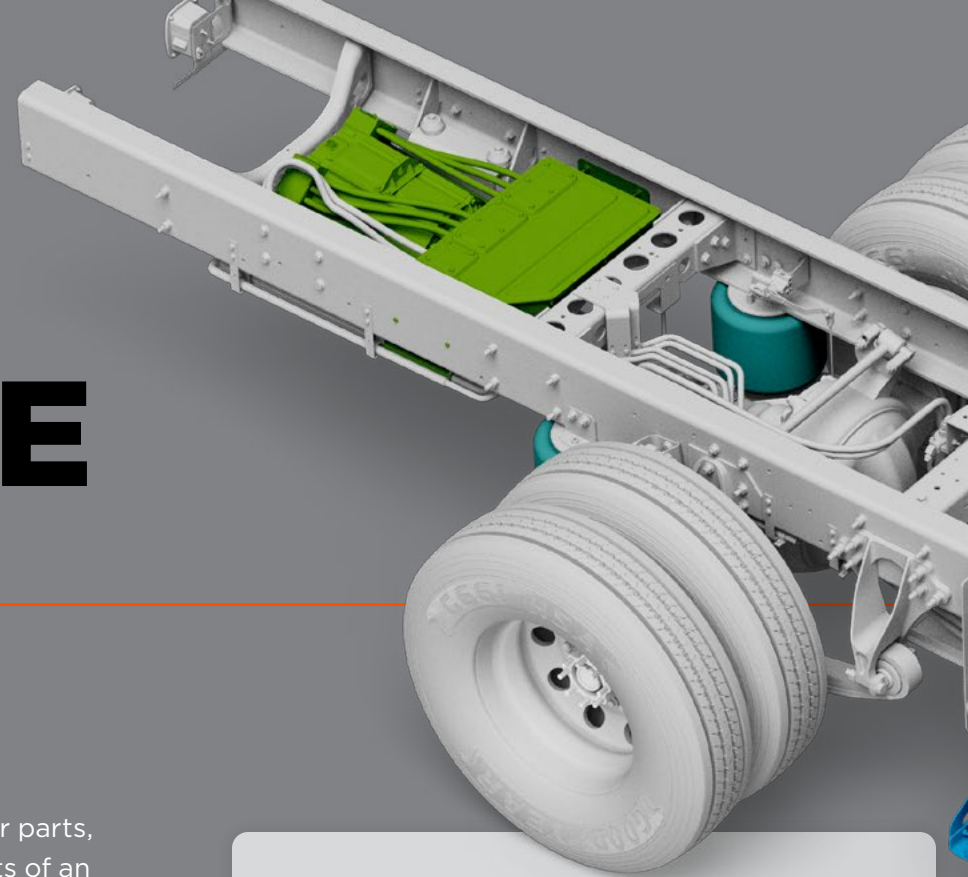

eMV™ SERIES COMPONENTS

- 1 Cooling module and BTMS - Battery Thermal Management System
- 2 Batteries and Controller
- 3 Motor and Drive Unit
- 4 Air Tank and Suspension Air Bags

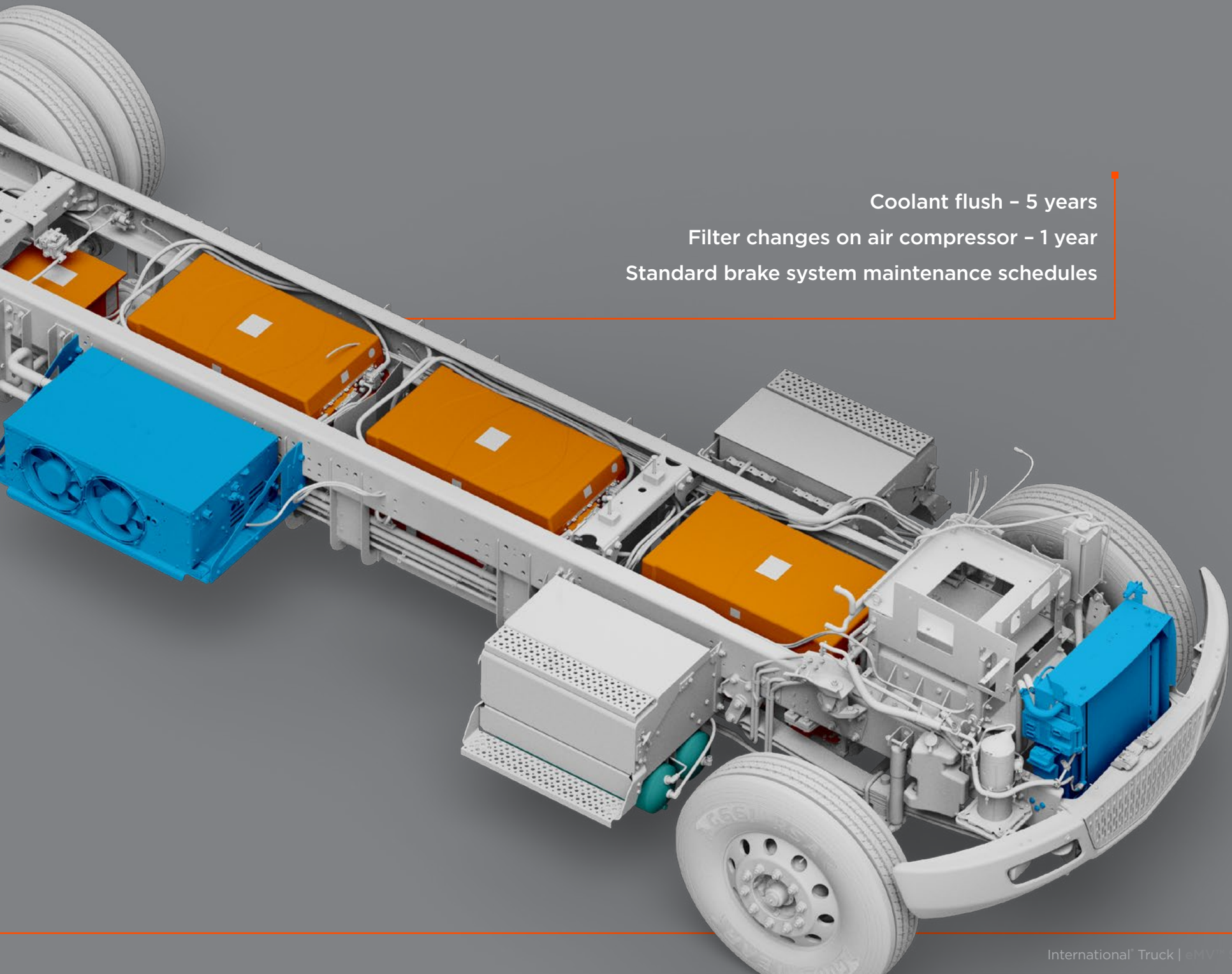

Coolant flush - 5 years
Filter changes on air compressor - 1 year
Standard brake system maintenance schedules



DRIVING PROFITABILITY

MORE TIME ON THE ROAD AND LESS TIME WAITING FOR REPAIRS

We understand making money means keeping your vehicles on the road. That's why uptime is so important to us. Dependable equipment spec'd for your needs or requirements is just the beginning. We also focus on fuel economy, preventive maintenance, optimized service intervals, and more to make sure the low cost of ownership of our vehicles helps keep you in the black.

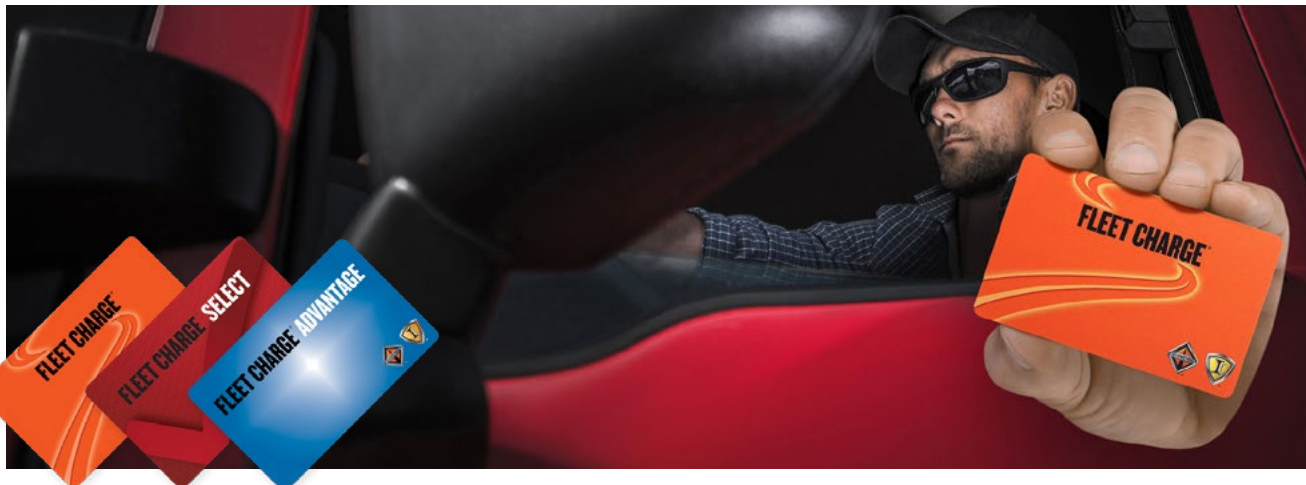

Maximum Uptime - Repair before Failure



Prognostics that move unplanned repairs to planned. Optimizing maintenance using vehicle performance and predictive data.

Predictive Parts Stocking



Dealer parts inventory management uses AI and telematics data to predict stocking needs. This ensures the best parts are on dealer shelves to support customers.

NAVISTAR FINANCIAL. UNLOCK YOUR POTENTIAL.

Navistar Financial offers flexible solutions to fit your financing needs, helping you secure the best products for your specific situation. Whether you're a loan customer or a lease customer the Navistar Financial team can provide you with the best option suited to your business.



For more information or to contact Navistar Financial, scan the QR code.

Scan me!

OVER
700
INTERNATIONAL®
DEALER LOCATIONS

OVER
400
LOVE'S TRUCK CARE
& SPEEDCO LOCATIONS

OVER
1,100
TOTAL SERVICE
LOCATIONS



TRUCK CARE

Our partnership with **Love's Truck Care & Speedco** adds 400+ additional locations for quick, conveniently located access to light mechanical and select warranty work*.

PARTS YOU NEED WHERE AND WHEN YOU NEED THEM

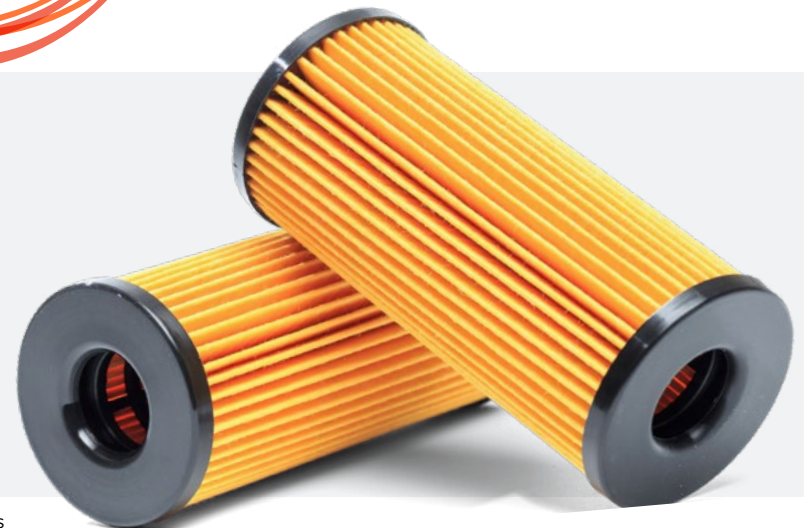

* Warranty-covered parts must be a certified International installed part for International Truck dealer service locations to honor warranty. Love's and Speedco locations in Texas and Louisiana cannot perform warranty services.



Note: The information and conclusions contained herein are believed to be correct at time of publication, but do not necessarily apply to similar vehicles with different specifications or with production dates after the production of this publication. Vehicles with different specifications or later dates of production may yield different results. Vehicle specifications are subject to change without notice. TAD21007 11/2023 ©2023 NAVISTAR Inc. All rights reserved. All marks are trademarks of their respective owners.