



**INTERNATIONAL®
S13 INTEGRATED
POWERTRAIN**



**INTERNATIONAL® S13
INTEGRATED POWERTRAIN**



A clean sheet of paper and decades of experience.
That's what the engineering team started with when they
began work on the International® S13 Integrated Powertrain.

ADVANCED. INTEGRATED. UNDISPUTED.



And this wasn't just any team. This was a dream team of engineers located literally all over the world. Thanks to this spirit of collaboration between partner companies, the team was able to shift what's possible and rethink, redesign and reinvent what an integrated powertrain can be. The result is an engine, transmission and aftertreatment system designed to work as one that's simple, easy to service and delivers stellar performance with superior operating economy.

In fact, the International S13 Integrated Powertrain can achieve up to a 15% gain in fuel economy* over the popular first-generation International® A26. This is one reason why we consider the International S13 Integrated Powertrain the most advanced system of its kind.

* Comparing the fuel economy of the 2017 GHG International® A26 engine in a 2017 International® LT® Series truck with aero package to the fuel economy of the new International® S13 Integrated Powertrain in a 2024 International® LT® Series truck with the LT aero package and chassis enablers. Actual customer results may vary due to various factors, including but not limited to, truck specifications, weight of the vehicle, predictive features, environmental conditions, etc.

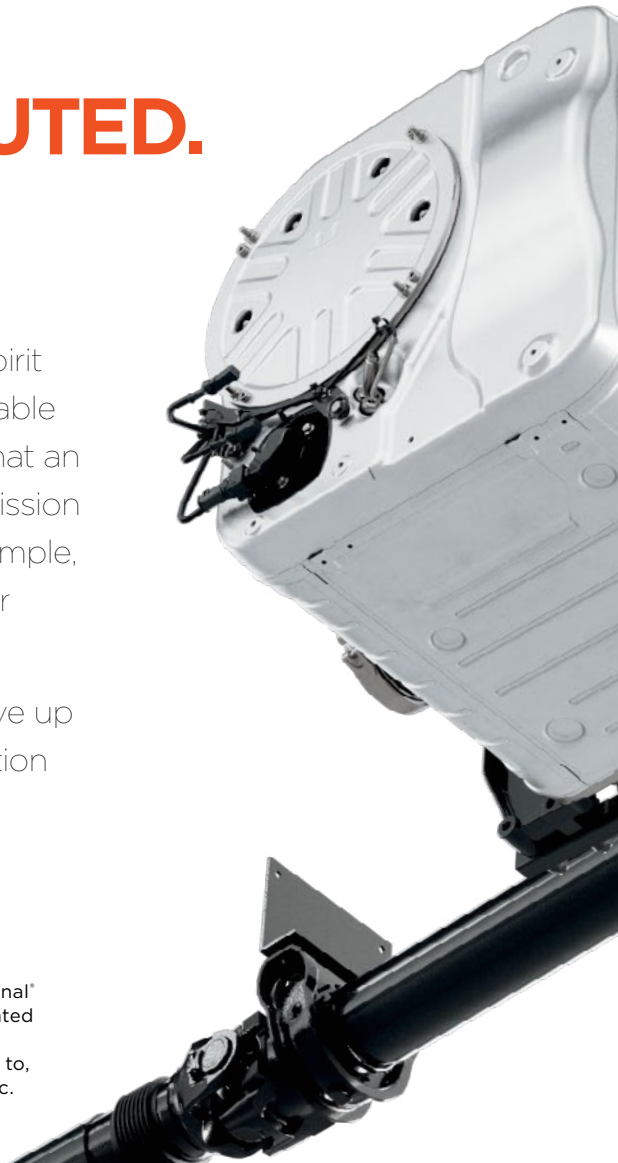

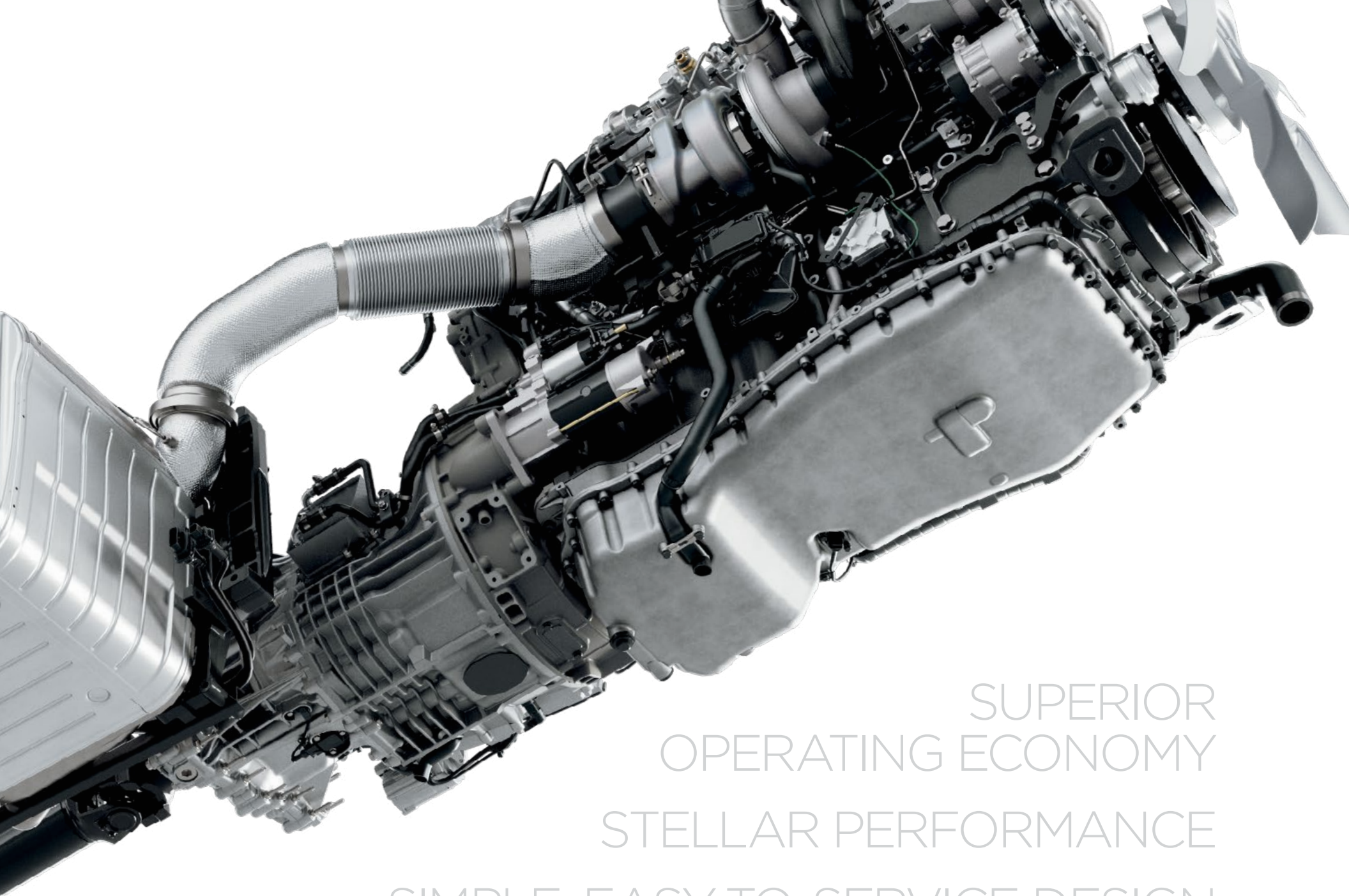

SUPERIOR
OPERATING ECONOMY
STELLAR PERFORMANCE
SIMPLE, EASY-TO-SERVICE DESIGN

THE PATH TO PERFECTION.

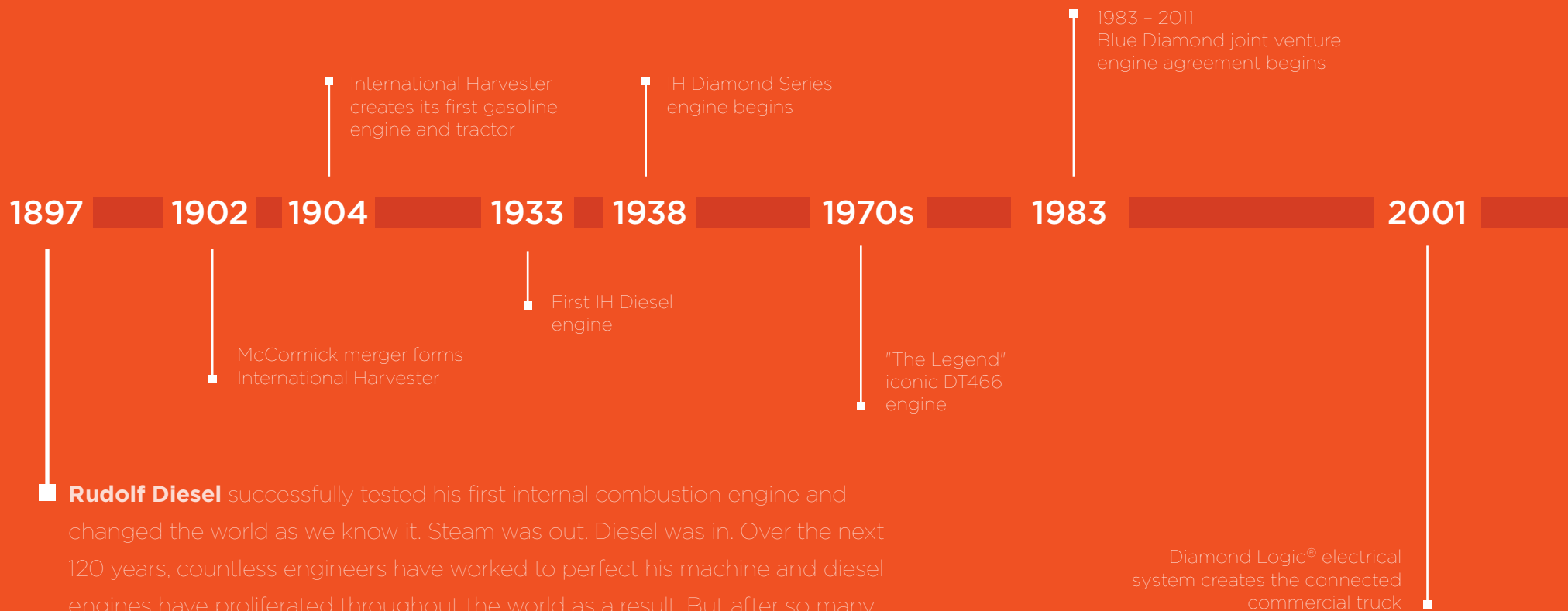

Enter: **TRATON GROUP**

Creating such a groundbreaking powertrain requires considerable resources and a deep bench of experts. Fortunately, the TRATON GROUP has an abundance of both. By cherry-picking the very best engineers from Scania, MAN and International, the team used their combined 300 years of experience to design and develop an integrated powertrain tailored to the specific regions where it is deployed.

In North America, for example, the powertrain was thoroughly road-tested in extreme locations like the Rocky Mountains and Alaska. International engineers also supervise the manufacturing of the engine at the Navistar Powertrain Manufacturing plant in Huntsville, Alabama.

TRATON

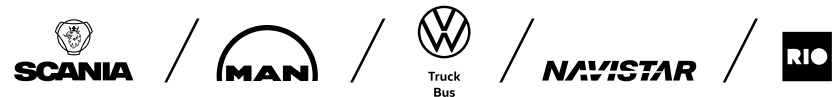

2016 | **2021** | **2022** | **2023**

Strategic partnership with VW forms and joint Integrated Powertrain development begins

Scania Super 13 production begins

S13 Integrated launches in the International® LT® and RH™ Series vehicles

S13 Integrated launches in the International® HX® Series vehicles

Navistar/TRATON merger completes

Scania launches Scania Super 13 in Europe

ENGINEERED TO PERFORM.



THE OPEN ROAD

When the road stretches over the horizon, it's comforting to know you have a powertrain that delivers outstanding reliability, powerful performance and exceptional fuel economy.



NO MATTER THE ARENA.



ON THE JOB

Brimming with features that can boost productivity, the S13 Integrated Powertrain* is equally adept when the road ends and the jobsite begins.

* Available in HX620





DESIGNED WITH FLEETS IN MIND.

Fits into your fleet like your favorite pair of work gloves.



The International® S13 Integrated Powertrain was engineered to seamlessly integrate into fleets of all sizes. Not only can fleets benefit from exceptional fuel economy, but they also get extended service intervals to keep their equipment on the road—plus the largest service network in the industry for convenient access to white-glove treatment from ASE-certified technicians. Fleets can even order (if desired) the International S13 Integrated Powertrain with a single or dual transmission mounted PTO option installed directly at the factory. The powertrain is also designed to work seamlessly with OnCommand® Connection Advanced Remote Diagnostics, which has helped some fleets reduce vehicle failures requiring a tow by up to 80%.

FLEET-FRIENDLY

- ▶ **Largest North American service network in the industry (with Love's network)**
- ▶ Single point of service for vehicle and powertrain
- ▶ Extended service/maintenance Intervals
- ▶ Wide selection of warranty & extended service contracts

DOING MORE WITH LESS

A powertrain that delivers superior operating economy.

100,000 miles/year

Gallons saved: 1,650

25-truck fleet: 41,250 gallons

Up to

15%

more fuel efficient*

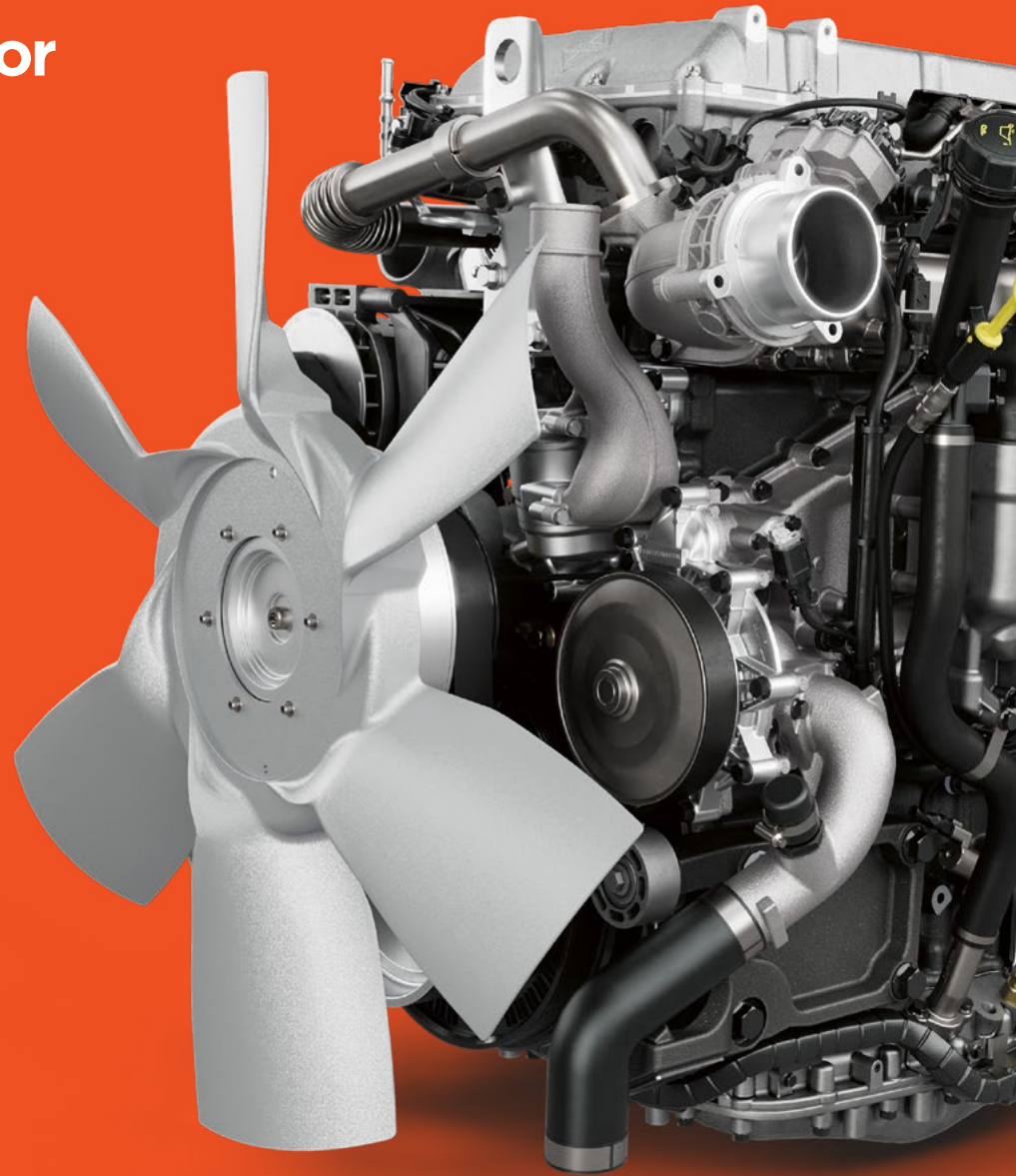

* Comparing the fuel economy of the 2017 GHG International® A26 engine in a 2017 International® LT® Series truck with aero package to the fuel economy of the new International® S13 Integrated Powertrain in a 2024 International® LT® Series truck with the LT aero package and chassis enablers. Actual customer results may vary due to various factors, including but not limited to, truck specifications, weight of the vehicle, predictive features, environmental conditions, etc.

No one thought it was possible. Except us.

Finding incremental fuel economy gains has kept diesel engineers busy for decades. And recently, most believed the diesel engine had already reached its limit in terms of efficiency. We didn't. If anything, we took it as a challenge. After all, not only does better fuel economy mean less CO² into the atmosphere, it's also better for businesses thanks to reduced operating costs, more payload capacity and, ultimately, greater profit.

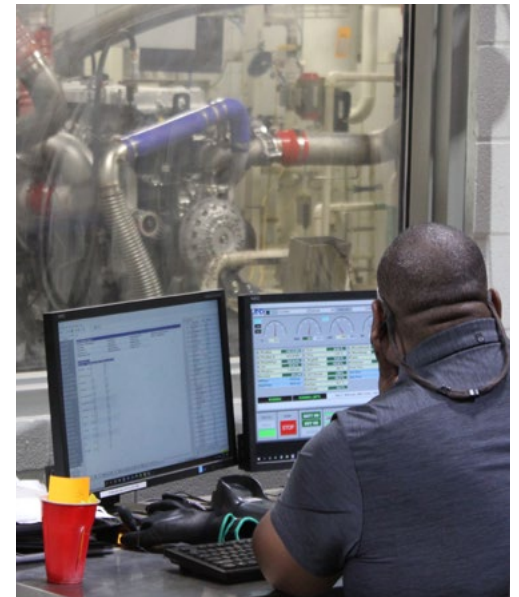



15% gain in fuel economy* over the first-generation International® A26 engine. So how did we do it?



The design of the combustion chamber and intake and exhaust ports are key contributors to the performance and efficiency of any engine. So we started there. And through exhaustive simulation work, a new cylinder and piston head design with maximum cooling properties was created. This new double overhead cam design with integrated compression release brake assembly and parallel valve pattern not only helps to reduce parasitic loss, but also directly equates to less fuel being consumed.

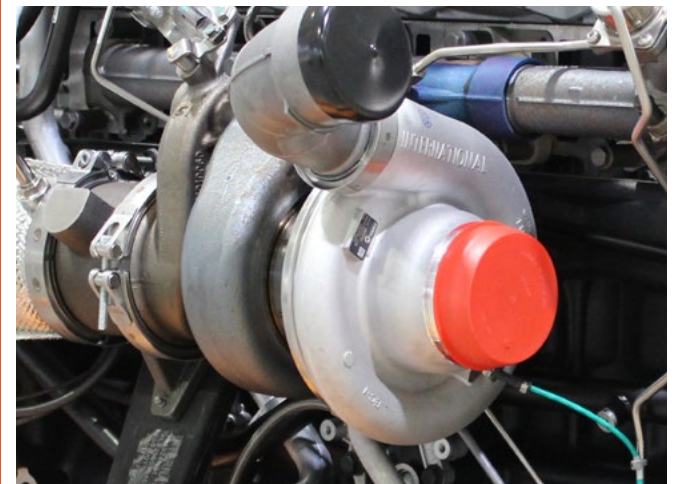
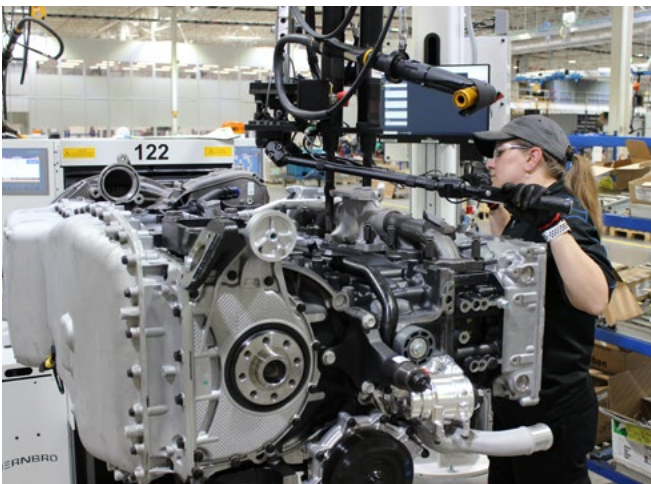



But that's not all. Thanks to the new dual stage aftertreatment module, a heavy (40–50 lbs), and expensive (approx. \$2,500) EGR cooler is no longer needed to reduce emissions. Its absence not only contributes to the S13 being the lightest 13-liter diesel engine available in North America, it also means nearly 100% of the exhaust flow goes through the simple, less complex fixed-geometry turbocharger for maximum performance and efficiency.

COMBUSTION EFFICIENCY

- Higher compression 23:1 ratio
- Higher air-to-fuel ratio of 27:1
- Optimal injection timing for most complete burn
- Lower fuel injection pressures required, reducing fuel pump losses
- Improved turbocharger efficiency due to reversed direction of turbo wheel that creates a more direct inlet flow

REDUCTION OF PUMPING LOSSES

- **Fuel pump** – Operating at lower pressure (1800 bar versus 2500 bar today) results in lower parasitic losses
- **Coolant pump** – Optimized size and flow fixed ratio pump with reduced pumping losses throughout the engine. Reduction in flow and parasitic loss versus our previous variable pump
- **Intake and exhaust manifolds** – efficient air passage designed to optimize air flow
- **Dual Overhead Cam (DOHC)** – the separate intake and exhaust cams allows better flow and efficiency

REDUCTION OF FRICTION

- Sleeve, ring and coating material improvements
- Bearing efficiencies throughout engine
- Transmission – Single countershaft geartrain design vs dual and Standard Integral Heat Exchanger with variable oil level system

* Comparing the fuel economy of the 2017 GHG International® A26 engine in a 2017 International® LT® Series truck with aero package to the fuel economy of the new International® S13 Integrated Powertrain in a 2024 International® LT® Series truck with the LT aero package and chassis enablers. Actual customer results may vary due to various factors, including but not limited to, truck specifications, weight of the vehicle, predictive features, environmental conditions, etc.

SHIFT WHAT'S POSSIBLE.

Any engine, no matter how well designed, is only as good as the transmission it's mated to. Delivering the power to the road in a smooth, predictable manner is no small feat when you consider the torque delivered by heavy trucks. Because they were developed in unison, the engine and transmission of the S13 Integrated Powertrain are designed to work in perfect harmony. The result is the fully automated manual T14 transmission with 14-speeds, including overdrive. Smooth shifts require no input from the driver in terms of being in the right gear at the right time.



HX
INTERNATIONAL





IT ALL COMES TOGETHER.

Collaboration is a beautiful thing. By combining the best thinking with years of experience in a wide range of disciplines, you can reduce potential pitfalls and accelerate progress in uncharted territory. And just like the team who developed it, the International Integrated Powertrain brings together three distinct entities to create a whole. The result is the S13 Engine, T14 Transmission, Dual Stage Aftertreatment system and nine PTO options — which, combined, make up the S13 Integrated Powertrain.

HIGH-PRESSURE FUEL SYSTEM

- ▶ Improved efficiency with less parasitic loss
- ▶ 1800 bar

FAN BLADES

- ▶ 6-and 9-blade configurations for application-specific efficiency

WATER PUMP

- ▶ Low displacement, low parasitic losses

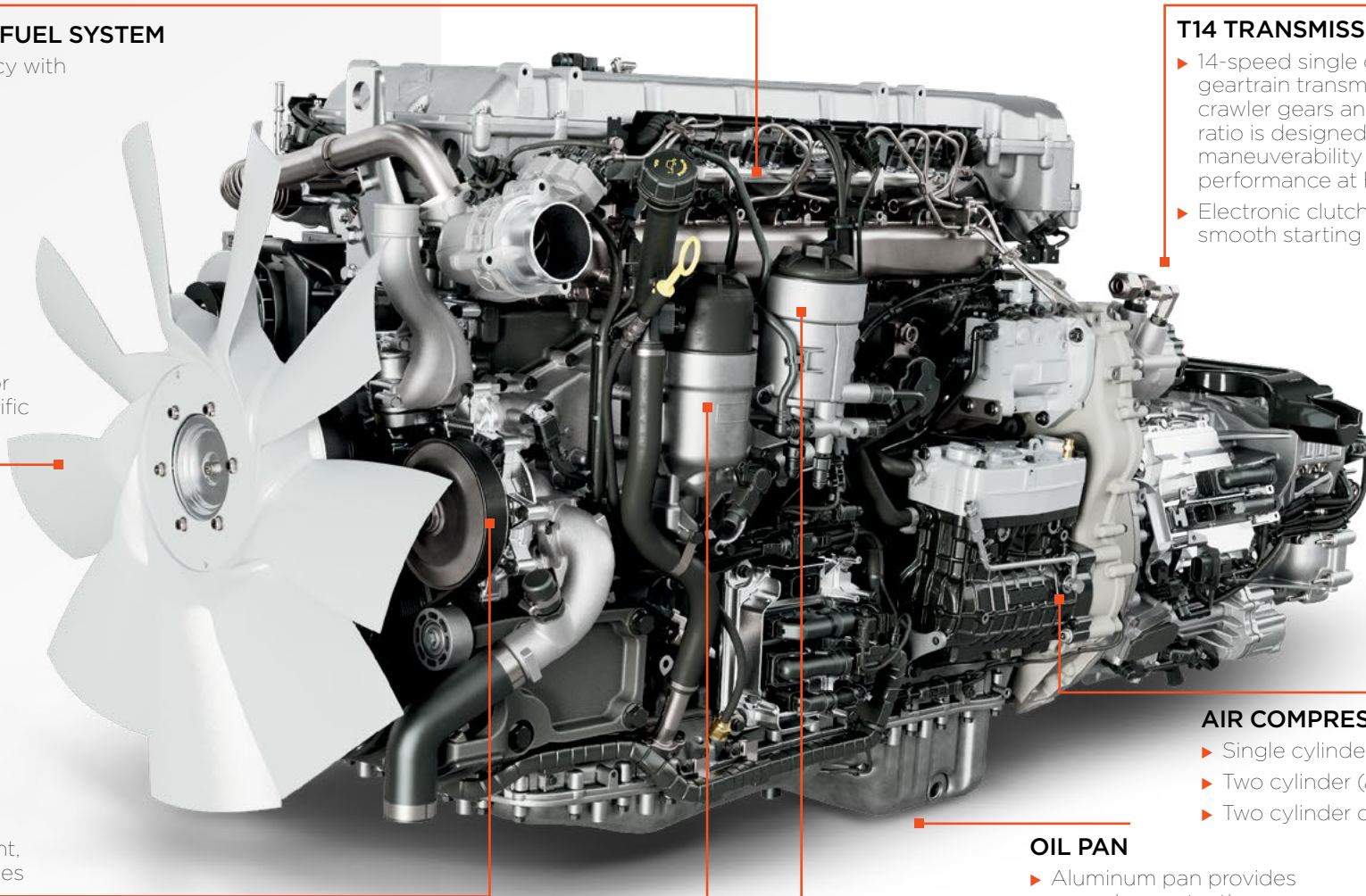

T14 TRANSMISSION

- ▶ 14-speed single countershaft geartrain transmission with 2 crawler gears and a 26.7 overall ratio is designed for slow speed maneuverability as well as performance at highway speeds
- ▶ Electronic clutch actuator for smooth starting and fast shifting

AIR COMPRESSORS

- ▶ Single cylinder (iron)
- ▶ Two cylinder (aluminum)
- ▶ Two cylinder clutched (aluminum)

OIL PAN

- ▶ Aluminum pan provides corrosion protection

OIL FILTER

FUEL FILTER

- ▶ Offered with industry-leading systems

DUAL STAGE AFTERTREATMENT

- ▶ Compact design for more frame rail mounting space
- ▶ No active DPF regen
- ▶ No diesel oxidation catalyst



ELIMINATION OF EGR COOLER

- ▶ Improved reliability

ALUMINUM VALVE COVER

- ▶ Rugged and lightweight

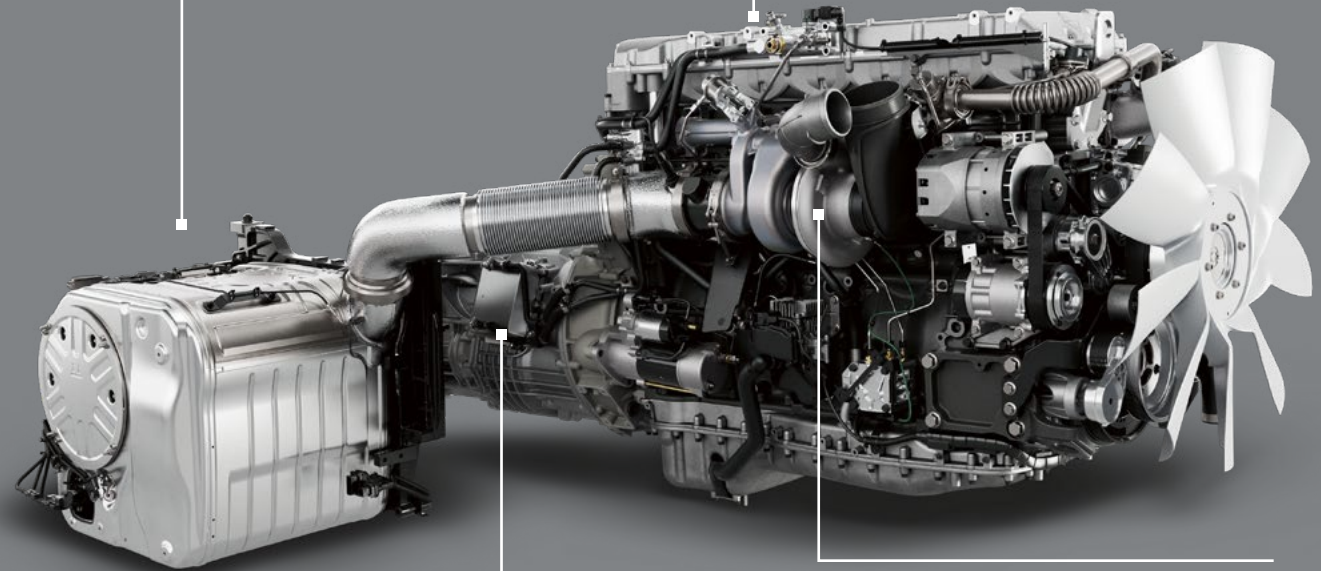

FIXED GEOMETRY TURBO

- ▶ More reliable and efficient design

STANDARD INTEGRAL HEAT EXCHANGER AND OIL SYSTEM

- ▶ No horsepower or torque restrictions
- ▶ Variable oil system with dry sump in high range allows for reduced parasitic loss

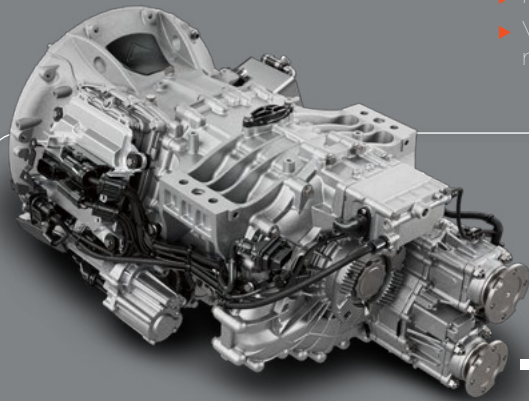

FACTORY-INSTALLED PTOs AVAILABLE

- ▶ Single- and dual-transmission PTOs available with a variety of common interfaces, installed directly at the factory
- ▶ REPTO and FEPTO options available without horsepower restrictions



READY TO WORK: ON THE ROAD OR AT THE JOBSITE

The International® S13 Integrated Powertrain was designed with hard work in mind. The S13 delivers performance through its robust lightweight design, optimized gearing and no active regens—leading to more payloads delivered on the jobsite.

- Outstanding payload capacity
- Simple design, easy serviceability
- Exceptional fuel economy
- Nine PTO options including a dual option

Plus, thanks to the seamless integration of OnCommand® Connection Advanced Remote Diagnostics, the visibility into the health, location and performance of your assets has never been more accessible.

T14 TRANSMISSION

The all-new T14 transmission was designed from the ground up to be a fully automated manual transmission. It's a 14-speed overdrive transmission that is optimized to deliver peak fuel economy performance in direct drive (13th gear) during typical load.

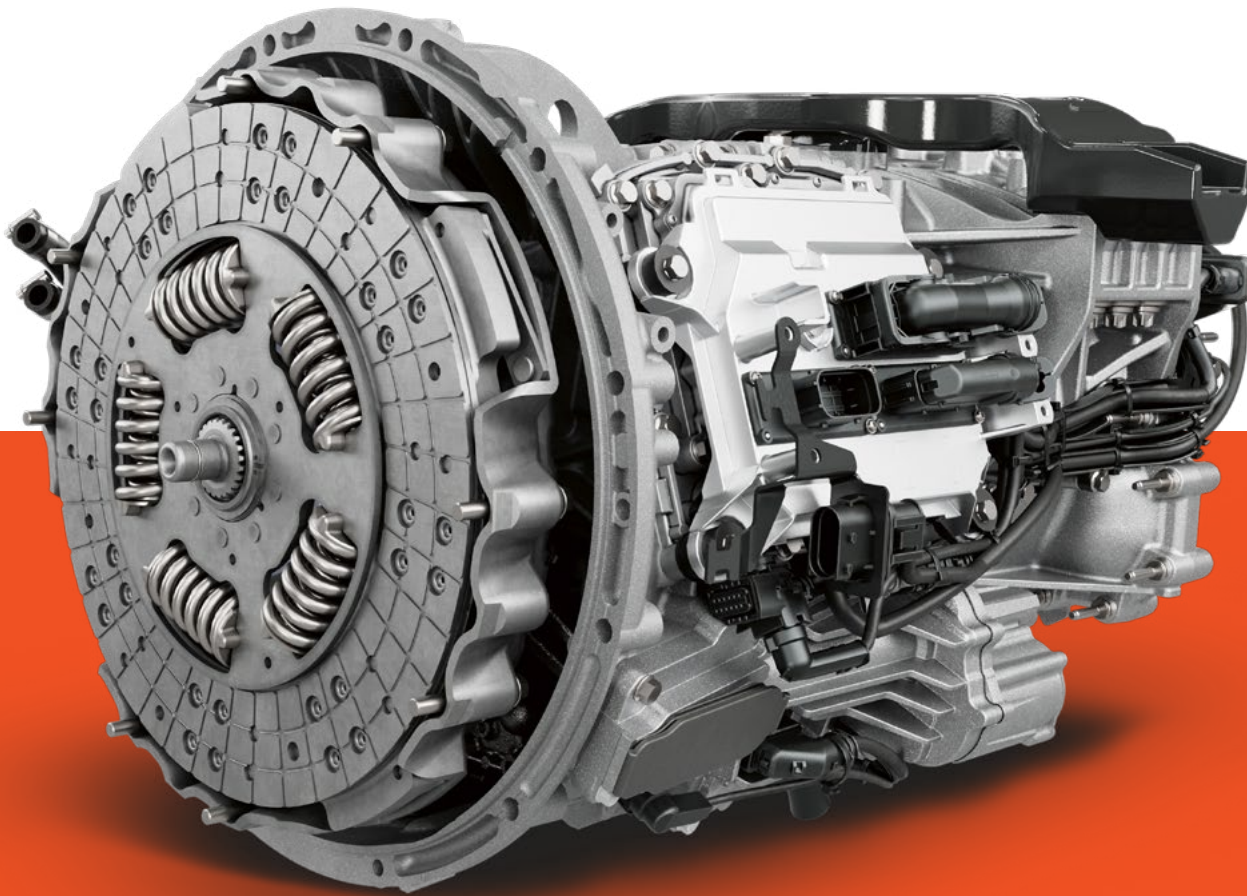

The transmission has an electronically controlled clutch actuator that works in sync with the engine to deliver faster, smoother shift performance. Since it does not consume air during complicated maneuvers – like when you're backing a trailer into a tight loading dock – the driver never needs to stop and let the air recharge. The T14 also uses an integrated oil-to-water coolant system to optimize temperature regulation in both hot and cold environments. This advanced feature is one reason why the T14 is able to achieve a Gross Combination Weight Rating (GCW) of up to 240,000 lb.



THE TRANSMISSION CONTROL MODULE (TCM)

Features like predictive cruise control, neutral coast, downhill speed control and predictive shifting can now be found in one module – the TCM. Combining these features into one module means the vehicle feels more natural and intuitive and, ultimately, more efficient.



DRIVE MODES

Three different shift modes (optional) for ultimate control for the driver

- ▶ Economy — Predictive shifting with fuel efficiency focus
- ▶ Performance — Perfect balance
- ▶ Performance+ — Shifting at peak power with focus on performance
- ▶ Off Road (HX Series only) — Ideal for off-pavement situations at the job site



ECO-COAST

Disengages the driveline when traveling downhill, using the momentum of the vehicle to save fuel.

ROCKING MODE

Extracts a truck that may have sunk into the ground by rocking it back and forth (without spinning the wheels) until it's free.

DOWNHILL SPEED CONTROL

Cruise control using the engine brake to slow down to a specific speed.

PAVER MODE

Enables the truck to be shifted from neutral into a forward gear without the driver needing to depress the brake. This helps ensure the smooth/uninterrupted delivery of material into the following asphalt paver.

MANEUVERING MODE

Gives the driver more control of the vehicle in low speeds for specific movements such as reversing into a loading dock, connecting to a trailer, navigating a tight construction site or other low-speed maneuvers. Torque value for pedal input is reduced. This mode allows the clutch to slip more easily for slow and smooth performance.

CREEP MODE

Allows the vehicle to automatically start moving when the brake pedal is released while the transmission is in gear. Useful in high traffic and other events where constant vehicle movement is necessary without the use of the accelerator pedal.

UPTIME ABOVE ALL ELSE.



When developing the International® S13 Integrated Powertrain, the engineers knew it needed to have iron-clad reliability out of the gate. They knew that businesses get nervous about investing in an unknown entity. That meant the powertrain spent twice as long on the dyno, drove over a million miles further in testing and was subjected to closer scrutiny than most engines developed before it. Plus, the European version of the powertrain has been on the road, racking up real-world miles – or kilometers – with an exceptional reliability record.

The aftertreatment system provides a simple, reliable solution that's easily serviceable.

Simple, elegant, easy to maintain.

The entire powertrain was designed to allow each individual component – engine, transmission and aftertreatment – to focus on doing what it does best. Eliminating the EGR cooler is a prime example. Instead of trying to control NOx emissions inside the cylinder, the engine operates with zero EGR during regular operation, so it can focus on generating more power. Plus, no cooled EGR during normal operation means nearly 100% of the exhaust flow goes through the turbo, allowing the use of a simple, more reliable fixed geometry turbocharger.

Eliminating a cooled EGR from the combustion cycle meant the engineers had to find another way to treat NOx. They accomplished this by developing a Dual Stage

■ **Aftertreatment design that injects a first dose of DEF just downstream of the turbo in the evaporator tube and a second dose inside the aftertreatment** module. Since cooled EGR has been eliminated from the combustion chamber, much less soot or particulate matter is generated. This allows for extended service intervals and eliminates the need for active regens. In fact, the cleaner combustion cycle has so much less soot that the engineers were able to eliminate the need for a diesel oxidation catalyst (DOC) in the aftertreatment system. Combined, the Dual Stage Aftertreatment system provides a simple, reliable solution that's easily serviceable.

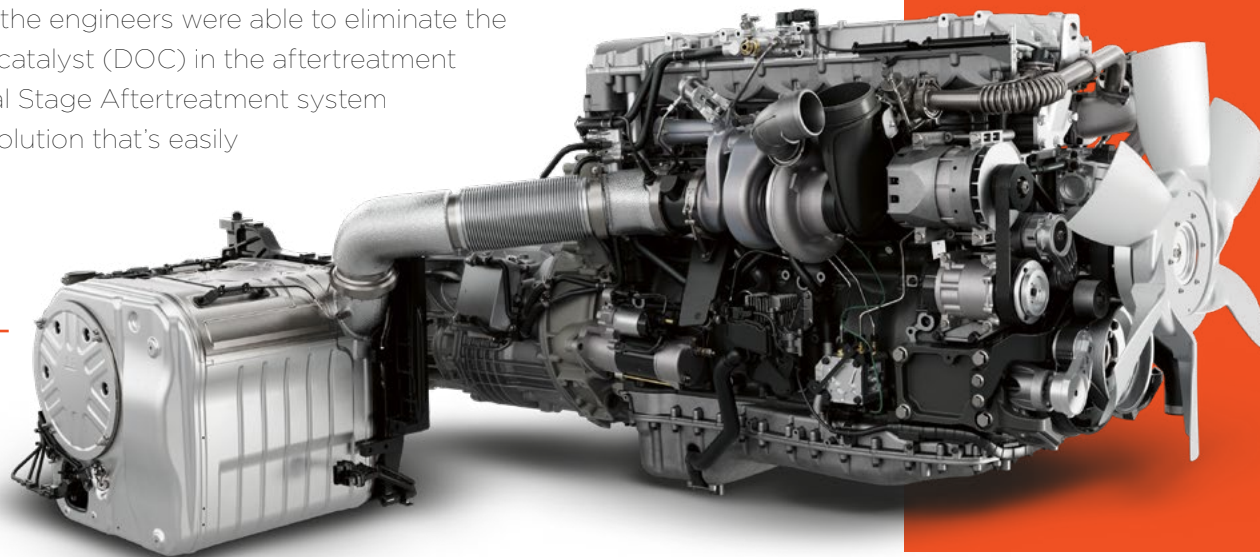

Improved airflow and volumetric efficiency through combustion chamber / integrated CRB (compression release engine brake)

Optimized piston assembly & cylinder design

Simple and reliable fixed geometry turbo – less prone to breakdowns

No EGR cooler – or \$2,500 replacement cost

Long beam transmission mount design provides improved durability and ride

Robust components – stronger mounting bolts on engine/cylinder block

REAL WORLD TORTURE TESTED.



The International® S13 Integrated Powertrain was verified in some of the most challenging environments in North America. It also spent time inside a state-of-the-art facility that can simulate 10 years of extreme temperature ranges that a truck may encounter out on the road.

COMMERCE CITY, CO (ALTITUDE, GRADE) / LAS VEGAS, NV (SUMMER, GRADE) / NORTH POLE, AK (WINTER TEMPS DOWN TO -40°F) / FARGO, ND (WINTER)
NEW CARLISLE, IN (DURABILITY EVENTS PLUS ROUTES) / INTERNATIONAL FALLS, MN (WINTER) / BEMIDJI, MN (WINTER) / APACHE JUNCTION, AZ (SUMMER TEMPS UP TO 110°F)

COMMERCE CITY, COLORADO

(ALTITUDE, GRADE)



NORTH POLE, ALASKA

(WINTER TEMPS DOWN TO **-40°F**)

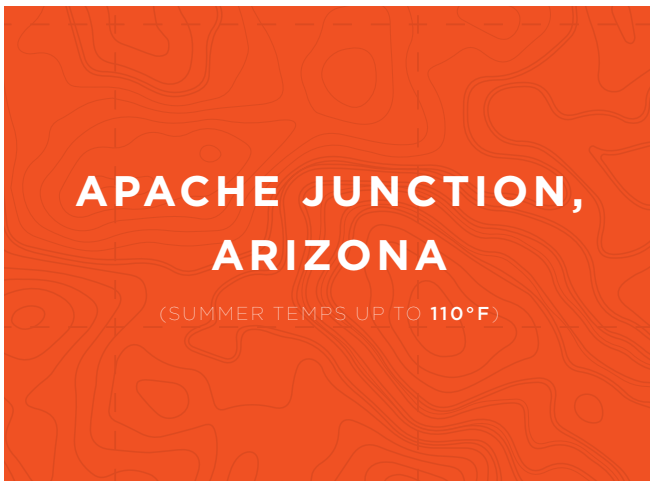

A DRIVER'S ENGINE.

Bringing stellar performance for those behind the wheel.

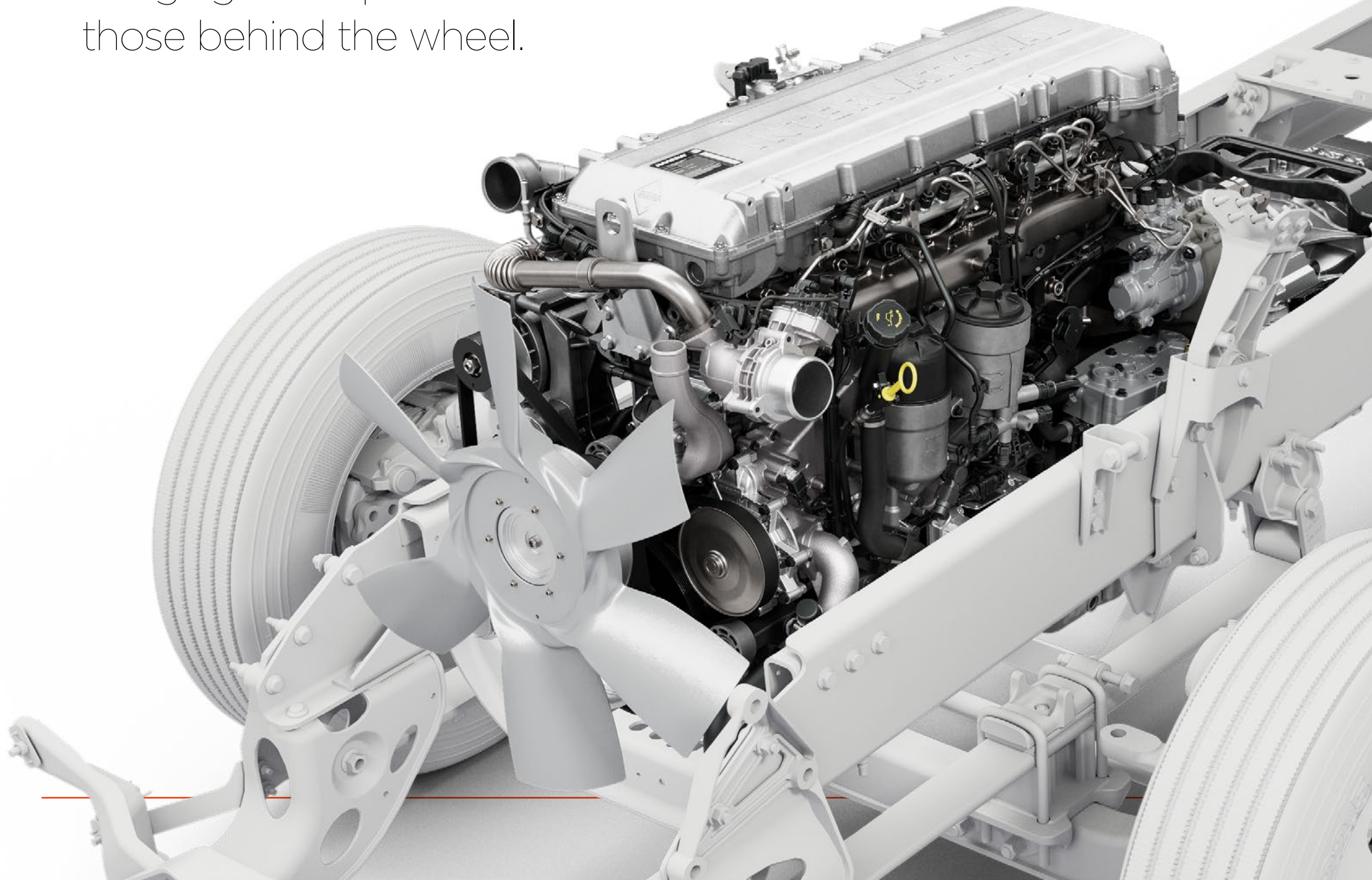

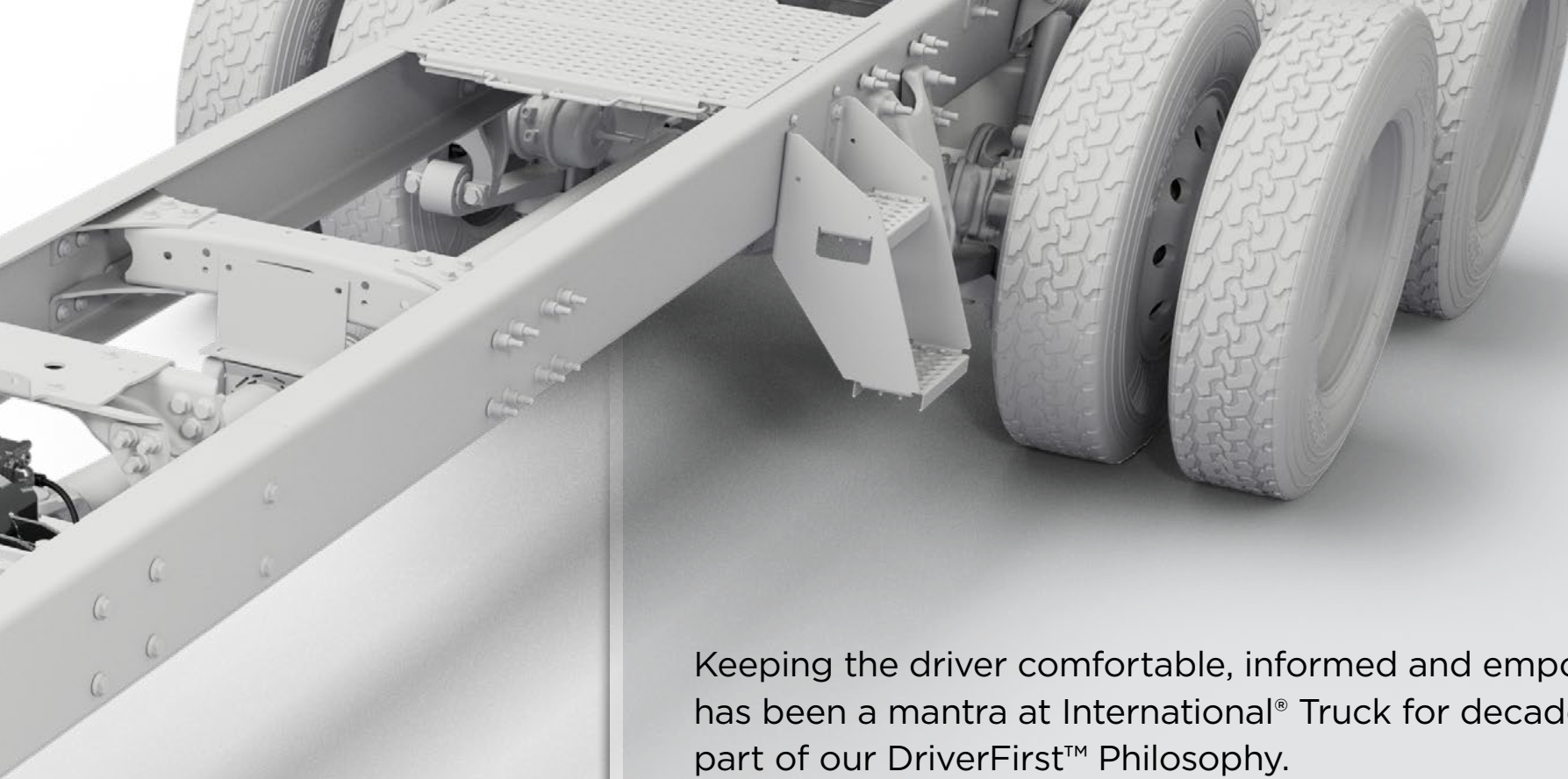

Keeping the driver comfortable, informed and empowered has been a mantra at International® Truck for decades as part of our DriverFirst™ Philosophy.



The International® S13 Integrated Powertrain takes it a step further by offering smooth and quiet operation with superior capabilities. At the jobsite, full torque is available at 900 RPM for nearly immediate power when it's needed most. On the highway, a wide gear ratio means optimal efficiency on flatlands with the performance drivers crave on hilly terrain. And when descending in either form, drivers can rely on the new compression release brake to deliver strong, secure braking power of up to 470 HP (at sea level) for quiet and effective braking.



Seamless integration of OnCommand[®] Connection enables:

- ▶ Comprehensive vehicle health reports
- ▶ Remote over-the-air programming:
 - Software calibration updates on all modules
 - Programmable parameter updates
- ▶ Advanced fuel analytics to help optimize driving efficiency
- ▶ Predictive repairs and maintenance
- ▶ Reduced unplanned downtime and costs
- ▶ Shorter service dwell times
- ▶ More efficient use of fleet assets

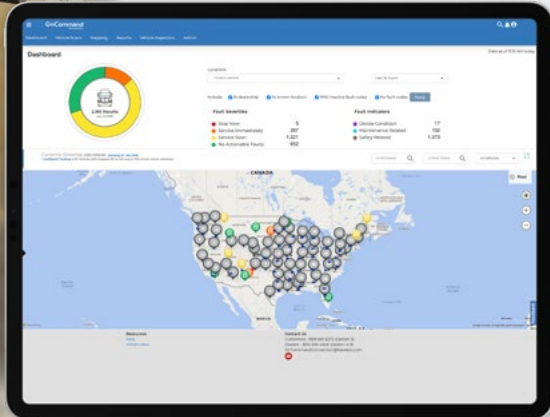



THE ONLY OEM SOLUTION THAT:

Connects your entire all-makes* fleet into one easy-to-use dashboard

Connects data from 30+ integrated telematics service providers

* For most commercial vehicles powered by diesel engines, 2007 MY and later.

S13 INTEGRATED

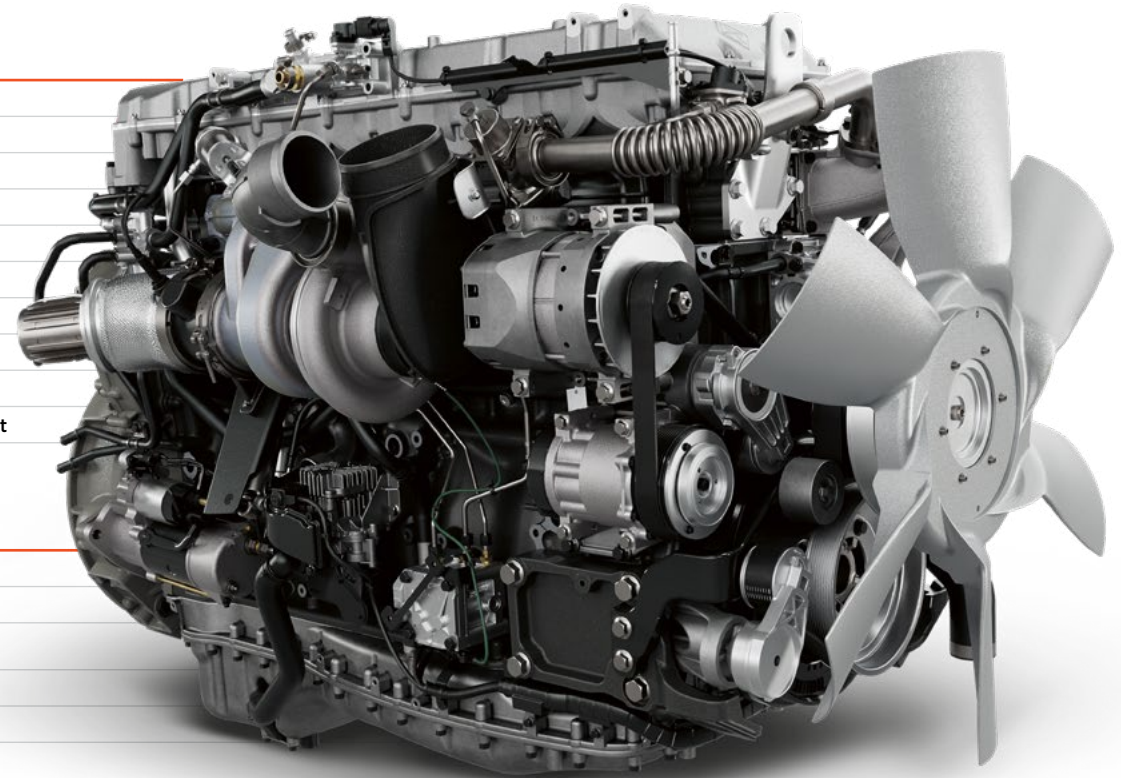

Engine Type	Diesel, 4-Cycle
Configuration	Inline 6-Cylinder
Displacement	12.74L (777 cu. in.)
Bore & Stroke	5.12 in. x 6.30 in. (126 mm & 166 mm)
Compression Ratio	23:1
Aspiration	Fixed Geometry Turbocharger
Combustion System	1800 bar Common Rail
Engine Lubrication	47.5 quarts (45L)
Total Engine Weight (Dry)	2,284 lbs. (1,036 kg)
Valves	4 Valves per Cylinder, Dual Overhead Camshaft
B10 Design Life	1,200,000 mi (1,931,000 km)

Industry-Leading Engine Warranty

Base Engine	2 years; unlimited miles, unlimited hours*
Base Major Component	5 years; 500,000 miles
Base Towing	2 years; unlimited miles, unlimited hours**
Optional Engine	Up to 6 years, 600,000 miles
Optional Major Component	Up to 7 years, 700,000 miles

* Fire & rescue applications: 60 months/100,000 miles/unlimited hours

**Towing for vehicles with engine failures



A WARRANTY AS STRONG AS THE ENGINE IT COVERS.

International® LT® and RH™ Series Transmission Base Warranty (Includes Towing)

Transmission	5 years, 750,000 miles (1,200,000 km)
Clutch	3 years, 350,000 miles (563,000 km)

International® HX® Series Transmission, Clutch and Transmission-Mounted PTO Base Warranty (Includes Towing)

Less than 52K Rear Axles Rating	3 years, unlimited miles
Greater than 52K Rear Axles Rating	2 years, unlimited miles

T14 BENEFITS

Transmission Key Benefits

Deep low-end gearing and shifting smoothness, delivering efficiencies of a direct drive in an overdrive package

14-speed including 2 crawler gears

Single countershaft transmission designed for simplicity and reliability

Vocational-specific drive modes, including paver, off-road and split shaft

Gear Ratios

Gear	Ratio	% Step
R6	4.59*	
R5	5.91*	
R4	7.61*	
R3	9.81*	
R2	12.60	
R1	16.23	
1	20.81	29%
2	16.16	29%
3	12.57	29%
4	9.76	29%
5	7.56	29%
6	5.87	29%
7	4.55	29%
8	3.53	28%
9	2.77	29%
10	2.15	29%
11	1.66	29%
12	1.29	29%
13	1.00	28%
14	0.78	-

* Optional

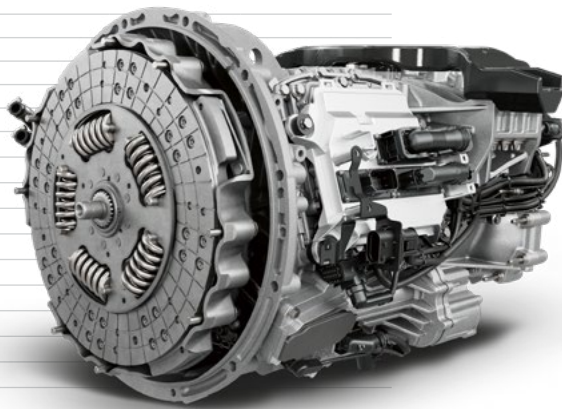

A/T BENEFITS

Dual Stage Aftertreatment Key Benefits

With Dual Stage Aftertreatment and significantly improved emission control, the combustion can be optimized further for improved performance and fuel efficiency.

- Two DEF injectors
- Dual Stage catalysts with upstream and midstream DEF dosing

No driver interaction required; the system manages the regeneration during operation

DPF filter does not need to be cleaned/replaced until 650,000 miles @ >8.2 mpg

Robust, compact aftertreatment allows less heat loss and helps significantly in improving the fuel economy and packaging



Dual Stage Aftertreatment Base Warranty

2 years, unlimited miles, unlimited hours

Horsepower and Torque

HP @ 1800 RPM	Torque [lb-ft] @ 900 RPM	Governed speed [RPM]
370	1250	2000*
400	1450	2000
400	1850	2000*
430	1550	2000
450	1750	2000
470	1750	2000*
475	1750	2000**
515	1850	2000

* LT Series and RH Series Only

** HX Series Only

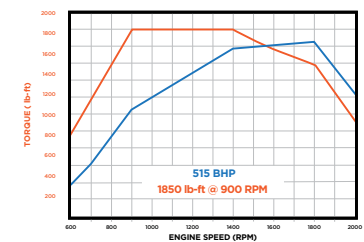
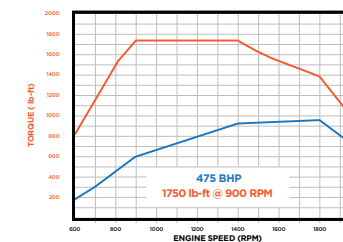
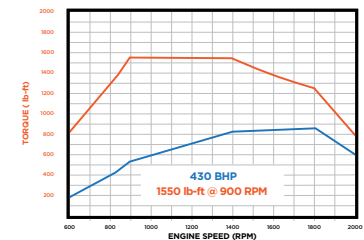
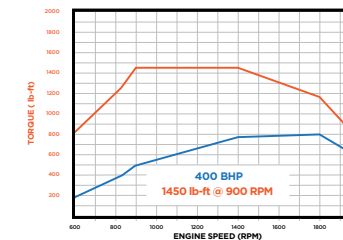



DRIVING PROFITABILITY

MORE TIME ON THE ROAD AND LESS TIME WAITING FOR REPAIRS

We understand making money means keeping your vehicles on the road. That's why uptime is so important to us. Dependable equipment spec'd for your needs or requirements is just the beginning. We also focus on fuel economy, preventive maintenance, optimized service intervals, and more to make sure the low cost of ownership of our vehicles helps keep you in the black.

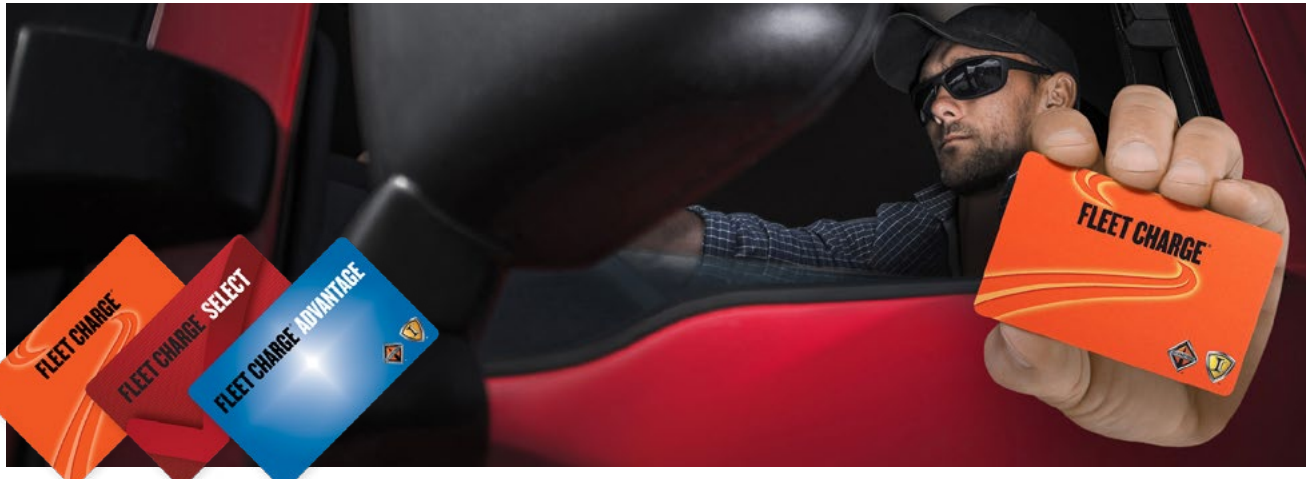

Maximum Uptime - Repair before Failure



Prognostics that move unplanned repairs to planned. Optimizing maintenance using vehicle performance and predictive data.

Predictive Parts Stocking



Dealer parts inventory management uses AI and telematics data to predict stocking needs. This ensures the best parts are on dealer shelves to support customers.

NAVISTAR FINANCIAL. UNLOCK YOUR POTENTIAL.

Navistar Financial offers flexible solutions to fit your financing needs, helping you secure the best products for your specific situation. Whether you're a loan customer or a lease customer the Navistar Financial team can provide you with the best option suited to your business.

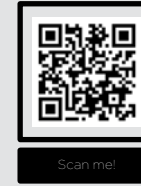

For more information or to contact Navistar Financial, scan the QR code.

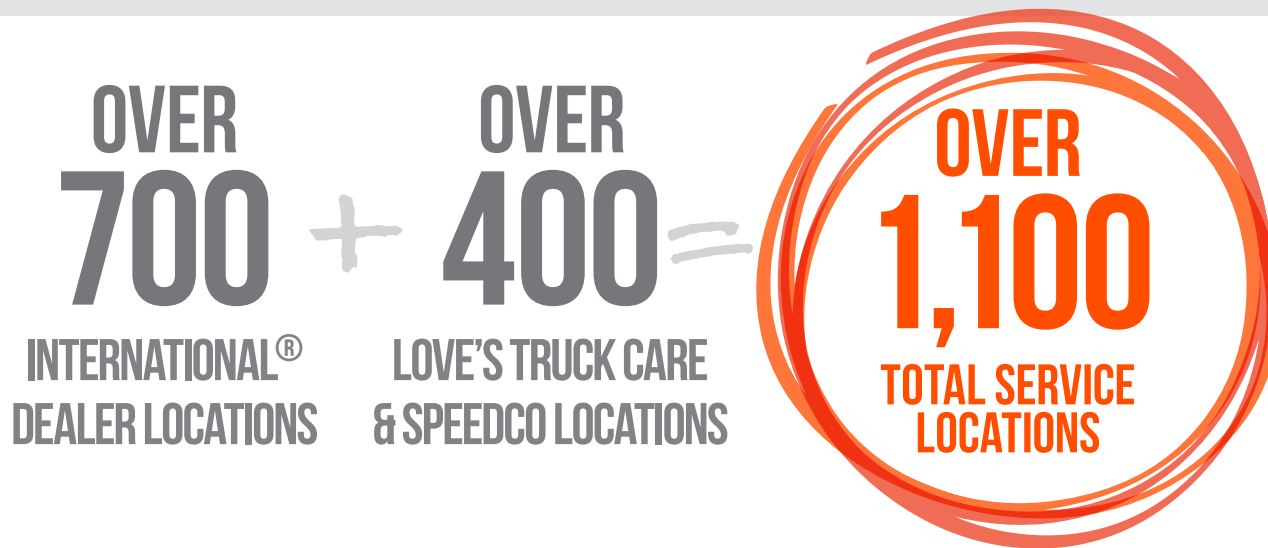

TRUCK CARE

Our partnership with **Love's Truck Care & Speedco** adds 400+ additional locations for quick, conveniently located access to light mechanical and select warranty work*.

PARTS YOU NEED WHERE AND WHEN YOU NEED THEM

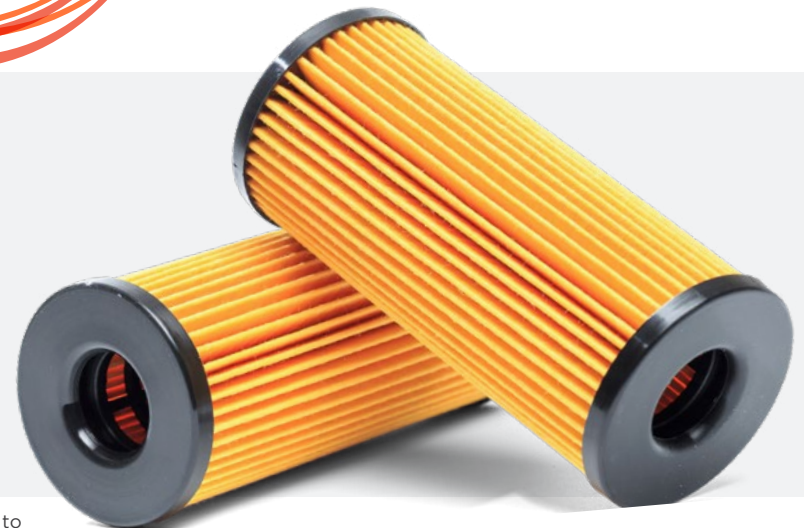

* Warranty-covered parts must be a certified International installed part for International Truck dealer service locations to honor warranty. Love's and Speedco locations in Texas and Louisiana cannot perform warranty services.



INTERNATIONAL[®] S13 INTEGRATED POWERTRAIN

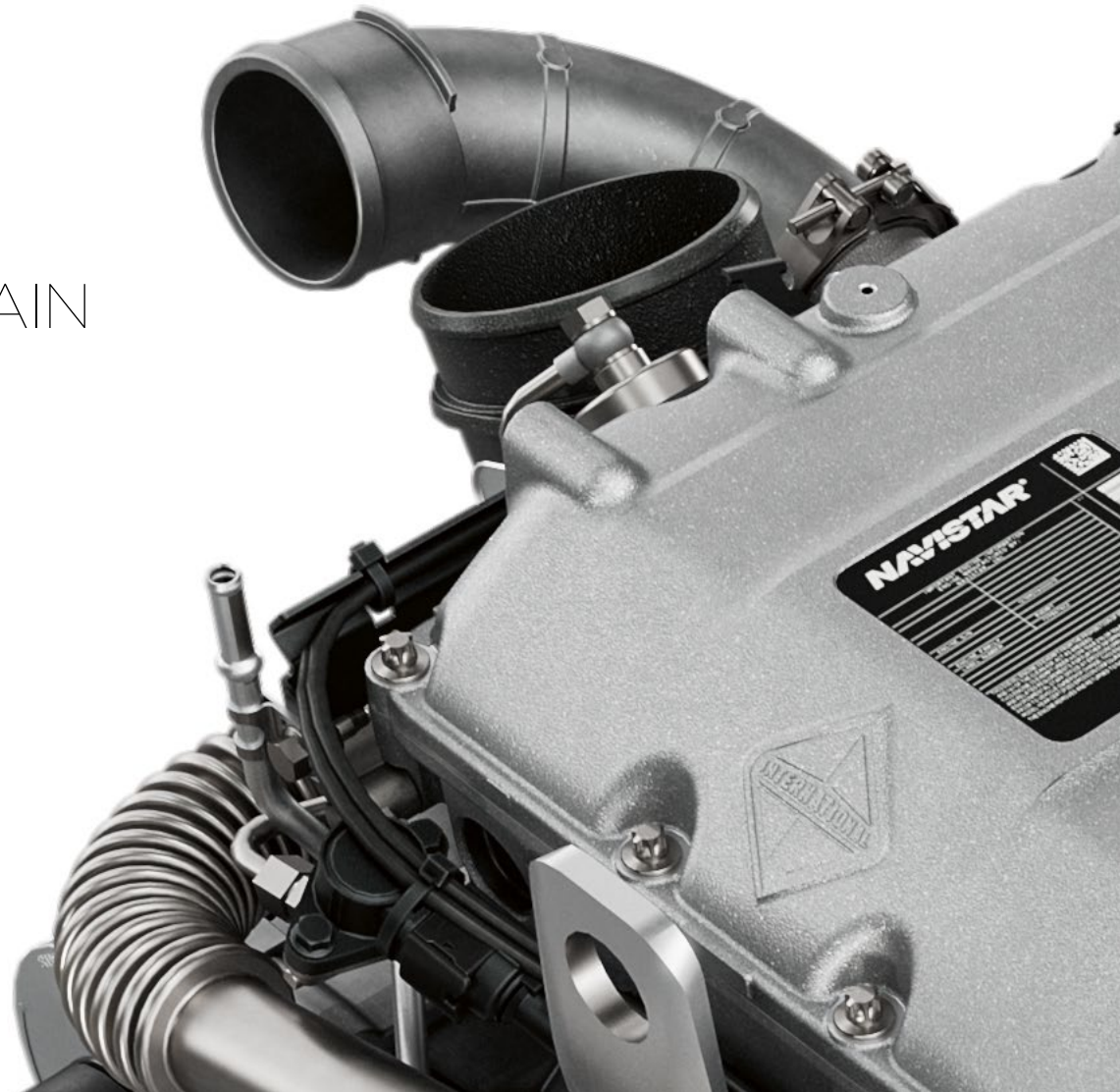

Note: The information and conclusions contained herein are believed to be correct at time of publication, but do not necessarily apply to similar vehicles with different specifications or with production dates after the production of this publication. Vehicles with different specifications or later dates of production may yield different results. Vehicle specifications are subject to change without notice. TAD22004 10/2023 ©2023 NAVISTAR Inc. All rights reserved. All marks are trademarks of their respective owners.