

ALL-MAKES PARTS CATALOG



A DEDICATION TO YOUR BUSINESS

Your business is all about uptime – and you need vehicles that can keep up. That’s why we offer the most comprehensive ownership programs in the industry.

Our robust warranties demonstrate our confidence in our products – products you can rely on to provide the uptime you require. Plus, our remote engine diagnostics and connected vehicle technologies give you full visibility into the health of your vehicles and on the status of repairs to aid with planning and scheduling.

And our state-of-the-art distribution system means parts are available where and when you need them. After all, time is money. Which is why International and IC Bus ownership programs focus on three priorities: lowering your cost of operation, providing the expert support you deserve, and being a partner that’s easy to do business with. We strive to deliver an ownership experience that goes above and beyond your expectations.





TABLE OF CONTENTS

1 BRAKES AND WHEEL END

1-17

Air Brake Charging	2
Air Disc Brake	3
Hydraulic Brakes	4
Air Brake Valves	4
Air Brake Actuators	6
Air Brake Controls and Sensors	7
Automatic Slack Adjusters	7
Drum Brake	8
Camshafts and Hardware Kits	10
Brake Drums	12
Wheels	13
Hubs	14
Seals, Bearings, Hubcaps	14
Tire Inflation	16
Axle Nuts	16

2 CAB EXTERIOR

18-34

Mirrors	19
Mirror Hardware	20
Wiper Blades, Arms and Motors	21
Windshields	23
Trim	23
Hoods	25
Hood Hardware	25
Bumpers	26
Bumper Hardware	28
Grille Assembly	28
Grille Components	29
Door Parts	29
Fuel Tank	30
Fuel Tank Accessories	30
Battery Boxes	31
Exterior Accessories	32

3 CAB INTERIOR

35-43

Radios and Antennas	36
Glass	37
Door Parts	38
Seats and Seat Covers	39
Mattresses and Mattress Covers	43

4 CHEMICALS AND LUBRICANTS

44-47

Oils and Greases	45
Coolants	46
DEF	46

5 DRIVETRAIN

48-55

Heavy-Duty Clutches	49
Medium-Duty Clutches	50
Clutch Accessories and Related Parts	50
Transmissions and Transmission Parts	51
Differentials and Differential Parts	52
Mobile Power	52
Driveline Components	54

6 ELECTRICAL

56-71

Rotating Electrical	57
Batteries	66
Cable, Wire, Connectors and Related Parts	67

7 ENGINES AND EMISSIONS

72-87

Cummins Engine	74
Filters	80
Engines	83
Turbochargers	83
Injectors	84
Overhaul Kits	84
Aftertreatment	85
EGR	86
Exhaust	86

8 ENGINE COOLING

88-97

Surge Tanks	89
Radiators	90
Charge Air Coolers	91
Fans	92
Fan Drives	93
Belts	94

9 FIFTH WHEEL AND COUPLINGS

98-100

Fifth Wheel	99
-------------------	----

10 HVAC

101-109

A/C Compressors	102
A/C Condensers	103
Receiver Driers and Accumulators	103
Blower Motors	104
Expansion Valves and Orifice Tubes	105
Switches and Resistors	106
Refrigerants and Relays	106
Auxiliary Heating and Cooling	107
Ventilation	108

11 LIGHTING 110-116

Headlamps.....	111
Stop/Turn/Tail, Side, Marker/Clearance.....	111
Work Lighting.....	115
Safety Warning Lighting.....	115
Cab Marker.....	115
Bulbs.....	116

12 SAFETY 117-120

Cargo Control.....	118
Fenders, Mudflaps and Accessories.....	118
First Aid.....	119
Miscellaneous.....	120

13 STEERING AND SUSPENSION 121-129

Steering.....	122
Suspension.....	123
Height Control and Leveling.....	127
Shock Absorbers.....	128

14 SHOP SUPPLIES 130-131

Tools and Equipment.....	131
--------------------------	-----

15 TRAILER PARTS 132-137

Suspension.....	133
Landing Gear.....	134
Trailer.....	135

16 BUS 138-144

Seating and Restraints.....	139
Safety Equipment.....	140
Lighting.....	142
Windows.....	143
Accessories.....	144

The data and information contained in this catalog is based upon information supplied from a variety of sources and is subject to change without notice or obligation. Although the data and information contained herein is believed to accurate, such data and information is provided by Navistar, Inc. ("Navistar") on a "AS IS" basis without any warranty or representation and may include errors or inaccuracies. Cross-references, descriptions, images, and applications contained in the catalog are intended to be used as a guide in identifying equivalent and/or possible replacement parts and are included for informational purposes only.

Many of the products listed in this catalog are subject to California Proposition 65 when sold in California, but due to space constraints, Navistar is unable to include warnings in this catalog. Information regarding Prop 65 can be found at the following website: <http://oehha.ca.gov/prop65.html>. Please consult product labeling or manuals for additional details about Prop 65 and products included in this catalog.

Navistar disclaims all representations and warranties, either expressed or implied, including any implied warranty of merchantability or fitness for a particular purpose, as to the accuracy of the data and information contained herein, including cross-references, descriptions, images and applications. Any warranties referenced in the catalog are the applicable manufacturer's warranties. Navistar disclaims any liability for any damages resulting from the use of or reliance on the data and information provided in this catalog. No part of this catalog may be reproduced or transmitted in any form or by any means, electronic or otherwise, without the express prior written consent of Navistar.

All marks of Navistar, including but not limited to Navistar brand names, product and service names and logos, such as, International®, IC Bus®, Fleetrite®, and ReNEWeD® are registered trademarks of Navistar, Inc.

Freightliner® is a registered trademark of Daimler Trucks North America LLC. Series 60™, Detroit®, Detroit Diesel®, DD13®, DD15® and DD16® are trademarks or registered trademarks of Detroit Diesel Corporation.

All other marks are trademarks of their respective owners. All rights reserved. All other product names, logos and designs used herein are the property of their respective owners and are used with permission.

YOUR MOST TRUSTED TOOL.



Order your International® Truck,
IC Bus® or all makes parts at
www.RepairLinkShop.com

Scan the QR code
to enroll:





FLEETRITE

AFFORDABILITY AND THE STOPPING PERFORMANCE YOU NEED.

Our wheel end parts are manufactured with the highest quality materials that meet or exceed OEM performance.

Order online at RepairLinkShop.com

PARTS FIT TO PERFORM

fleetrite.com



MERITOR

BRAKE-THROUGH TECHNOLOGY FROM THE PROVEN BRAKE LEADER.

Meritor® brake shoes with PlatinumShield® III coating provide exceptional resistance to rust-jacking and corrosion while extending the life of your brakes.

meritorpartsexpress.com

AIR BRAKE CHARGING



COMPRESSORS

PN	APPLICATION	HALDEX X-REF	MERITOR X-REF	FLEETRITE X-REF	BENDIX X-REF
5002983	Caterpillar	ZZ5002983X	R9555002983X	—	BX5002983
5002984	Caterpillar	ZZ5002984X	R9555002984X	—	BX5002984
5004144	—	—	—	—	—
5004187	Detroit Diesel®	ZZ5004187X	R9555004187X	—	BX5004187
5004188	Detroit Diesel®	ZZ5004188X	R9555004188X	—	BX5004188
5004613	International	ZZ5004613X	R9555004613X	FLTBC113	BX5004613
5004614	Caterpillar or International	ZZ5004614X	R9555004614X	FLT614	BX5004614
5012533	Caterpillar	ZZ5012533X	R9555012533X	—	BX5012533
5012663	Caterpillar	—	—	—	BX5012663
5012664	Caterpillar	—	—	—	BX5012664
5019320	International	ZZ5019320X	—	—	BX5019320
5019321	Caterpillar	ZZ5019320X	—	—	BX5019321
5019322	International	ZZ5019322X	—	—	BX5019322
5019445	International	ZZ107514X	R9555019445X	—	BX5019445
K095124	Caterpillar	—	—	—	BXK095124
K095125	Detroit Diesel®	—	—	—	BXK095125
107506	Cummins	ZZ107506X	R955107506X	FLTBC106	BX107506
107514	International	ZZ107504X	R955107514X	FLT114	BX107514



AIR DRYERS AND PURGE VALVE KITS

PN	DESCRIPTION	FLEETRITE X-REF	BENDIX X-REF	WABCO X-REF	MERITOR X-REF	RANGER BRAKE X-REF	HALDEX X-REF
065225	Bendix AD-9® New Air Dryer	FLTAD065225	BX065225	—	R955065225N	RB65225	ZZ109685X
065612	Bendix AD-IP® New Air Dryer	—	BX065612	—	R955065624N	—	—
109477	Bendix AD-IP® Remanufactured Air Dryer	—	BX109477	—	R955109477X	—	—
109685	Bendix AD-9® Remanufactured Air Dryer	FLTAD9685	BX109685	—	R955065225X	RB109685	ZZ109685X
109995	Bendix AD-SP® New Purge Valve Kit	—	BX109995	—	R955109995N	—	—
131031	Bendix AD-SP® New Air Dryer with SC-PR Valve	—	BX131031	—	—	—	—
5004341	Bendix AD-9® Remanufactured Purge Valve Kit	FLTBV4341	BX5004341	—	R9555004341X	—	ZZ5004341X
5010696	Bendix AD-IS® Remanufactured Air Dryer	FLTAD0696	BX5010696	—	R9555010696X	—	ZZ5010696X
800405	Bendix AD-9® New Purge Valve Kit	—	BX800405	—	R955800405N	—	ZZ800405CX
800576	Bendix AD-IP® New Air Dryer with Extended Purge	—	BX800576	—	—	—	—
800887	Bendix AD-SP® New Air Dryer	—	BX800887	—	R955109991XCF	RB955205	—
801266	Bendix AD-IS® New Air Dryer	—	BX801266	—	R9555010696X	—	—
802191	Bendix AD-IS® New Air Dryer Less Reservoir	—	BX802191	—	—	—	—
K022105	Bendix AD-IS®/AD-IP® New Purge Valve Kit	FLTBV2105	BXK022105	—	R955K022105N	—	ZZK022105K
K049199	Bendix AD-IS® New Air Dryer Less Reservoir	—	BXK049199	—	—	—	—
432 413 929 2	ZF Model SSI200 New Purge Valve Kit	—	—	WAB4324139292	—	—	—
400 611 050 0	ZF Model SSI200 New Air Dryer	—	—	WAB4006110500	—	—	—
RWABK118	ZF Model SSI200 New Air Dryer	—	—	WABRWABK118	—	—	—
K164293SC	Air Dryer AD-HF Unit	—	BXK164293SC	—	—	—	—
5004050	—	FLTAD4050	BX5004050	—	R9555004050X	—	ZZ5004050X



Fleetrite® Air Disc Brakes – Affordability and Stopping Power

Fleetrite air disc brake parts are manufactured with the highest quality materials that meet or exceed OEM performance. Fleetrite products are high-quality aftermarket solutions for International® vehicles as well as many other Original Equipment Manufacturer (OEM) truck applications. Fleetrite air disc brakes provide the affordability and the stopping performance you need.

fleetrite.com



AIR BRAKE CHARGING (CONT'D)



DESICCANT CARTRIDGES

PN	DESCRIPTION	FLEETRITE X-REF	BENDIX X-REF	WABCO X-REF	MERITOR X-REF	RANGER BRAKE X-REF
65624	Bendix AD-IP® New Desiccant Cartridge	—	BX65624	—	R955065624N	—
107794	Bendix AD-9® Remanufactured Desiccant Cartridge	—	BX107794	—	R955107794XCF	RB107794
107796	Bendix AD-9® New Desiccant Cartridge	—	BX107796	—	R955107796N	RB107796
109493	Bendix AD-IP® Remanufactured Desiccant Cartridge	FLT109493	BX109493	—	R955109493XCF	—
5008414	Bendix AD-SP®/AD-IS® New Desiccant Cartridge	FLT109994	BX5008414	—	—	RB109994
5008414PG	Bendix AD-SP®/AD-IS® New Coalescing Desiccant Cartridge	FLTAD5008414PG	BX5008414PG	—	—	—
432 420 923 2	WABCO Model SS1200 New Desiccant Cartridge	—	—	WAB4324209232	4324209232	—
432 901 248 2	WABCO Model SS1200 New Coalescing Desiccant Cartridge	—	—	WAB4329012482	4329012482	—
5009041PG	Air Dryer Cartridge Kit AD-HF	—	BX5009041PG	—	—	—
107794PG	AD-9® Air Brake Dryer Cartridge Kit	FLTAD107794PG	BX107794PG	—	R955107794PGX	RB107794
109477PG	AD-IP® Air Brake Dryer, Remanufactured	—	BX109477PG	—	R955109477PGX	—
109493PG	AD-IP® Air Dryer Cartridge Kit, Remanufactured	FLTAD109493PG	BX109493PG	—	R955109493PGX	—
109685PG	AD-9® Air Brake Dryer, Remanufactured	FLTAD109685PG	BX109685PG	—	R955109685PGX	RB109685
5008414GC	Bendix AD-SP®/AD-IS®	—	BX5008414GC	—	—	RB109994

AIR DISC BRAKE



BRAKE PADS

AIR DISC BRAKE SYSTEM	FLEETRITE X-REF	MERITOR X-REF	BENDIX X-REF	WABCO X-REF	RANGER BRAKE X-REF
Meritor EX+ L	FLTADBP1370H	MMD1370AF	BXAMP1370BA	—	RBAD1370LHP
WABCO Pan 19	FLTADBP1438H	MMD1438AF	BXAMPW1438BA	WAB6401959472	RBAD1438LHP
WABCO Pan 17	FLTADBP1518H	MMD1518AF	BXAMPW1518BA	WAB6401759522	RBAD1518LHP
WABCO Pan 22	FLTADBP1777H	MMDWP22AF	BXAMPW1777BA	WAB6402259382	RBAD1777LHP1
Maxxus	FLTADBP2061H	MMD2061AF	BXAMPW2061BA	WAB6403229342	RBAD2061LHP
Hendrickson Maxx 22T	FLTADBP1777TH	MMD1777M22TAF	BXAMPW1777BA	WAB6402229382	RBAD1777LHP2
Bendix ADB22X-LT, Bendix ADB22X	FLTADBP1369H	MMD1369AF	BXK129276, BXK182236	—	RBAD1369LHPC, RBAD2403LHP
Hendrickson Maxx 22T Trailer	FLTADBP1777TH	MMD1777M22TAF	—	WAB6402229382	RBAD1777LHP2
Bendix SB7, SN7 Brake Pad Sets	FLTADBP1203H	MMD1203AF	—	—	RBAD1203LHP
Meritor D-ELSA 2 Brake Pad Sets	—	MMD1310AF	—	—	RBAD1310LHP
Meritor EX225H2 Brake Pad Sets	FLTADBP1311H	MMD1311AF	—	—	RBAD1311LHP



ROTORS

AIR DISC BRAKE SYSTEM	ROTOR SIZE	FLEETRITE X-REF	MERITOR X-REF	BENDIX X-REF	WABCO X-REF	CONMET X-REF	WEBB X-REF	RANGER BRAKE X-REF
Meritor EX+ L	—	—	M44D802082, M44DH18609	—	—	CNM10020682, CNM10020109	W55071PK, W55072PK	RB76617
WABCO Pan 19	—	—	M44D71601	BXAMR2220N	WAB13162046 (front) WAB13162047 (rear)	—	W55031PK65	RB71601
WABCO Pan 17	—	—	M44D75180	BXAMR2224N	—	—	W55030PK65	RB75180
WABCO Pan 22	—	—	—	BXAMR2232N	—	—	W55032PK65, W55097P65	RB76801
Maxxus	—	—	—	—	—	—	W56090PK	RB76620
Hendrickson Maxx 22T	—	—	—	—	WAB6402229292	—	W55035PK	RB76901
Bendix ADB22X	Splined Flat Rotor Kit	FLTADBR430045S	M44DH802569	BX802569	—	—	—	—
Bendix ADB22X	"U" Shaped Rotor 150mm	FLTADBR430150U	M44D802082	BXK038574	—	10012031, 10019897, 10041006, 10082074	—	—
Bendix ADB22X	"U" Shaped Rotor 160mm	FLTADBR430160U	M44DH20682	—	—	10020109, 10020682	—	—
Bendix ADB22X	"U" Shaped Rotor 138mm	FLTADBR430138U	M44D802081	BXK038573	—	10082589	—	—
Bendix ADB22X	"U" Shaped Rotor 131mm	FLTADBR434131U	M44D23642	—	—	—	—	—
Bendix ADB22X	Flat Rotor	FLTADBR430053F	M44DH18609	—	—	10018609, 10085621	—	—
Hendrickson Maxx 22T Trailer	"U" Shaped Rotor 150mm	FLTADBR430150UTR	M44DHS34172006	—	—	—	W55098P65	RB76901

AIR DISC BRAKE (CONT'D)



NEW AND REMAN CALIPERS

AIR DISC BRAKE SYSTEM	MERITOR X-REF		BENDIX X-REF		WABCO X-REF		RANGER BRAKE X-REF	
	Left Hand	Right Hand	Left Hand	Right Hand	Left Hand	Right Hand	Left Hand	Right Hand
WABCO Pan 19	—	—	—	—	WAB40195037	WAB40195038	RBPN19W195037L	RBPN19W195038R
WABCO Pan 17	—	—	—	—	WAB40175072	WAB40175073	RBPN17W175072L	RBPN17W175073R
WABCO Pan 22	—	—	—	—	64MM Bolt Pattern WAB6402250800	64MM Bolt Pattern WAB6402250810	—	—
WABCO Pan 22	—	—	—	—	84MM Bolt Pattern WAB40225015	84MM Bolt Pattern WAB40225016	RBPN22W225015L	RBPN22W225016R
Maxxus	—	—	—	—	MAXXUS 1.0 Radial WAB6403220650	MAXXUS 1.0 Radial WAB6403220660	RBMAXS322065L	RBMAXS322066R
Maxxus	—	—	—	—	MAXXUS 1.1 Axial WAB6403221060	MAXXUS 1.1 Axial WAB6403221070	RBMAXS322065L	RBMAXS322066R
Hendrickson Maxx 22T	—	—	—	—	WAB6402220070	WAB6402220080	RBMX22T222007L	RBMX22T222008R
Bendix ADB22X	Trailer Axle M802984X	Trailer Axle M802985X	BXK098272SC, BXK149714SC	BXK098273SC, BXK149715SC	—	—	—	—
Bendix ADB22X	Steer and Drive MK081142X	Steer and Drive MK081143X	Axial Mount BXK097850SC	Axial Mount BXK097851SC	—	—	—	—
Bendix ADB22X	Steer and Drive MK081256X	Steer and Drive MK081257X	Vertical Mount BXK097846SC	Vertical Mount BXK097847SC	—	—	RB22XK97844A	RB22XK97845B
Hendrickson Maxx 22T Trailer	—	—	—	—	WAB6402220070	WAB6402220080	RBMX22T222007L	RBMX22T222008R

HYDRAULIC BRAKES



BRAKE PADS

DESCRIPTION	FLEETRITE X-REF	MERITOR X-REF	BENDIX X-REF	RANGER BRAKE X-REF
Bendix 2-19/32" Twin Piston	FLTH184	MMD184	BXE11101840	RBHD01847108
Bendix 2.88" Twin Piston	FLTH225	MMD225	BXMK225HD	RBHD02257819
Meritor 64/70 Quadraulic	FLTH769	MMD769	BXE11107690	RBHD07697636
Bosch 73mm Twin Piston	FLTH786	MMD786	BXE11107861	RBHD07867654
Bosch 66mm Twin Piston	FLTH786A	MMD786A	BXMKD786A	RBHD07867655
Meritor 2-1/2" Twin Piston	—	MMD224	BXMK224HD	RBHD02247141
Bendix 2-19/32" Twin Piston	—	MMD380	BXE10514380	RBHD03807815
Isuzu and GM 54mm Twin Piston	—	MMD825	BXE11108250	RBHD08257697
TRW 60mm Twin Piston	—	MMD1066	—	RBHD10667972



AIR BRAKE VALVES



DUAL BRAKE VALVES

PN	DESCRIPTION	FLEETRITE X-REF	INTERNATIONAL X-REF	BENDIX X-REF	MERITOR X-REF	RANGER BRAKE X-REF
101818N	E-7™ Brake Valve	FLTBV1818	—	BX101818N	R955101818N	RB101818
106453	E-6® Brake Valve	—	452950C92	BX106453	RKN22150	—
286171	E-6® Brake Valve	FLTBV6171	—	BX286171	R955286171N	RB286171
800599	E-8P® Brake Valve	—	—	BX800599	—	—
800646	E-8P® Brake Valve	—	2506077C92	BX800646	—	—
800647	E-8P® Brake Valve	—	2506079C91	BX800647	—	—
802911	E-6® Brake Valve	—	—	BX802911	—	—



AIR BRAKE VALVES (CONT'D)



DASH CONTROL VALVES

PN	DESCRIPTION	BENDIX X-REF	MERITOR X-REF	RANGER BRAKE X-REF
065661	PP-DC® Control Valve	BX065661	—	—
800257	MV-3® Control Valve	BX800257	RKN20615	—
800259	MV-3® Control Valve	BX800259	RKN20623	—
800260	MV-3® Control Valve	BX800260	—	—
800516	MV-3® Control Valve	BX800516	R955800516N	RB65157
800523	MV-3® Control Valve	BX800523	RKN20612	—
800617	PP-DC® Control Valve	BX800617	—	—
800840	MV-3® Control Valve	BX800840	—	—
800841	PP-DC® Control Valve	BX800841	—	—
801682	MV-3® Control Valve	BX801682	—	—
802122	MV-3® Control Valve	BX802122	—	—
802177	PP-DC® Control Valve	BX802177	—	—
802804	MV-3® Control Valve	BX802804	—	—
K036861	MV-3® Control Valve	BXK036861	—	—
K066652	MV-3® Control Valve	BXK066652	—	—
K095874	MV-3® Control Valve	BXK095874	—	—



RELAY VALVES

PN	DESCRIPTION	BENDIX X-REF	MERITOR X-REF	WABCO X-REF
065146	BP-R1® Bobtail Brake Proportioning Relay Valve	BX065146	R955065146N	—
065476	R-12P™ Pilot Relay Valve	BX065476	RKN28300	—
103835	R-14® Relay Valve	BX103835	R955103835X	—
800305	R-12® Relay Valve	BX800305	—	WABRKN28061
800483	R-12® Relay Valve	BX800483	—	—
801591	R-14® Relay Valve	BX801591	—	—
803115	R-12® Relay Valve	BX803115	—	WABRKN28071

SPRING BRAKE VALVES

PN	DESCRIPTION	BENDIX X-REF
K021557	SR-7® Spring Brake Modulating Valve	BXK021557
K021558	SR-7® Spring Brake Modulating Valve	BXK021558
K021559	SR-7® Spring Brake Modulating Valve	BXK021559
K021560	SR-7® Spring Brake Modulating Valve	BXK021560
K021562	SR-7® Spring Brake Modulating Valve	BXK021562

TRACTOR PROTECTION VALVES

PN	DESCRIPTION	BENDIX X-REF	MERITOR X-REF
107430	TP-5™ Tractor Protection Valve	BX107430	—
288605	TP-5™ Tractor Protection Valve	BX288605	R955288605N
800024	TP-5™ Tractor Protection Valve	BX800024	—
800396	TP-5™ Tractor Protection Valve	BX800396	—
800588	TP-5™ Tractor Protection Valve	BX800588	—

QUICK RELEASE VALVES

PN	DESCRIPTION	FLEETRITE X-REF	BENDIX X-REF	MERITOR X-REF	RANGER BRAKE X-REF	WABCO X-REF
107261N	QR-1® Quick Release Valve	—	BX107261N	RKN32006	—	WABRKN32006
289714N	QR-1C® Quick Release Valve	—	BX289714N	R955289714N	RB289714	—
800348	QR-1C® Quick Release Valve	—	BX800348	—	—	WABRKN32041
802743	QRN™ Quick Release Valve	—	BX802743	—	—	—
802744	QRN™ Quick Release Valve	—	BX802744	—	—	WABRKN32005
802745	QRN™ Quick Release Valve	—	BX802745	—	—	—
800333	QR-L™ Inline Quick Release Valve	FLTBV333	BX800333	R955800333N	—	—



AIR BRAKE VALVES (CONT'D)



DRAIN VALVES

PN	DESCRIPTION	BENDIX X-REF	MERITOR X-REF	RANGER BRAKE X-REF	WABCO X-REF
281923N	DV-2™ Drain Valve	BX281923N	R955281923N	RB281923	—
284817N	DV-2™ Drain Valve with Heater	BX284817N	—	—	WABRKN24001

ANTI-LOCK MODULATOR VALVES

PN	DESCRIPTION	BENDIX X-REF
K128916OR	Bendix M-40QR™ Modulator	BXK128916OR
K079670OR	Bendix M-40QR™ Modulator	BXK079670OR
K161888OR	Bendix M-40HF™ Modulator	BXK161888OR

GOVERNORS

BENDIX PN	DESCRIPTION	MERITOR X-REF	BENDIX X-REF	RANGER BRAKE X-REF	FLEETRITE X-REF	WABCO X-REF
275491N	D-2° Governor, 100–120 PSI	R955284358N	BX275491N	RB18530	FLTBV5491	WABRKN18530
275707N	D-2° Governor, 105–125 PSI	R955284358N	BX275707N	—	—	—
277486N	D-2° Governor, 110–130 PSI	RKN18532	BX277486N	—	—	—
5004049	D-2° Governor with Delivery Check Valve, Governor has AD-IS™ PreSet	R9555004049N	BX5004049	—	—	—
5010669N	D-2A° Governor, Non-Adjustable	RKN18532	BX5010669N	—	—	WABRKN18530
800361N	D-2° Governor, Non-Adjustable	—	BX800361N	—	—	—
284358N	D-2° Governor, Non-Adjustable	—	BX284358N	—	FLTBV358	—



AIR BRAKE ACTUATORS



BRAKE CHAMBERS

PN	ACTUATOR SIZE	STROKE TYPE	PIGGYBACK	WELDED CLEVIS	MGM X-REF	MGM NON-WELDED X-REF	HALDEX X-REF	HALDEX NON-WELDED X-REF	FLEETRITE X-REF	BENDIX X-REF	MERITOR X-REF	RANGER BRAKE X-REF
1428901	24	Extra Long	No	Yes	ZAJ1428901	ZAJ1428001	ZZSC24XLCW	ZZSC24XL	—	BXK025365	R870024SEL Non-Welded	RBBSC24LS
1431901	30	Long	No	Yes	ZAJ1431901	ZAJ1431001	ZZSC30LCW	ZZSC30	—	—	R870030SEL Non-Welded	RBBSC30LSWC225
3224951	2430	Extra Long	No	Yes	ZAJ3224951	ZAJ3224008	ZZGC2430XLCW	ZZGP2430XL	—	—	A843276X24	RBBTS2430LS
3230008	3030	Long	Yes	—	ZAJ3230951	ZAJ3230008	ZZGC3030LCW	—	FLTK3030LB24	BXNT3030ELSKIT	R873030CEL Non-Welded	RBBPS3030KLSB
3230051	3030	Long	Combo SAE	—	ZAJ3230951	ZAJ3230051	ZZGC3030LS4CW	—	FLT3030LB20	BXNT3030ELS80	—	RBBTS3030LS
3230551	3030	Standard	Combo 12" Rod	—	ZAJ3230951	ZAJ3230551	ZZGC3030LS4CW	—	—	—	—	RBBTS3030LSX
3230951	3030	Long	No	Yes	ZAJ3230951	ZAJ3230008	ZZGC3030LCW	ZZGP3030LK	FLT3030LCB20	BXNT3030ELSWC	A893276D30	RBBTS3030LSWC225
3232951	3030	Long	No	Yes	ZAJ3232951	ZAJ3232008	ZZGC3030LCW	ZZGP3030LK	—	BXNT3030ELSWC	—	RBBTS3030LSWC225
3234951	3036	Standard	No	Yes	ZAJ3234951	ZAJ3234008	ZZGC3036LCW	ZZGP3030LK	—	—	R8730306C Non-Welded	RBBTS3036LSWC225
3430008	3030	Standard	Combo SAE	—	ZAJ3430951	ZAJ3430008	ZZGC3030CW	—	FLT3030SB28	BXNT3030STDKIT	R870031	RBBPS3030KSC
3430051	3030	Standard	Combo SAE	—	ZAJ3430951	ZAJ3430051	ZZGC3030CW	ZZGP3030K	—	BXNT3030STD120	C313276D30	RBETS3030
3430951	3030	Standard	No	Yes	ZAJ3430951	ZAJ3430008	ZZGC3030CW	ZZGP3030K	FLT3030SCB20	BXNT3030STDWC	R873030C Non-Welded	RBBTS3030WC225



AIR BRAKE CONTROLS AND SENSORS



ABS ELECTRONIC CONTROL UNITS

PN	DESCRIPTION	BENDIX X-REF	WABCO X-REF
801167	Bendix EC-30™ ECU	BX801167	—
801179	Bendix EC-30™ ECU	BX801179	—
801335	Bendix EC-30™ ECU	BX801335	—
K058637	Bendix EC-60™ ECU	BXK058637	—
K058703	Bendix EC-60™ ECU	BXK058703	—
K060096	Bendix EC-60™ ECU	BXK060096	—
K065135	Bendix EC-60™ ECU	BXK065135	—
K065144	Bendix EC-60™ ECU	BXK065144	—
S400-612-010-0	WABCO ECU with Valve	—	WAB4006120100
S400-612-000-0	WABCO ECU with Valve	—	WAB4006120000
S400-500-103-0	WABCO ECU with Valve	—	WAB4005001030

AUTOMATIC SLACK ADJUSTERS



SLACK ADJUSTERS

PN	ARM LENGTH	SPLINES	FLEETRITE X-REF	RANGER BRAKE X-REF	MERITOR X-REF	MOTOR WHEEL X-REF	GUNITE X-REF	BENDIX X-REF
AS1131	5	10	—	RB1131	R806914	ZCPMK21103S	ZBRAS1131	BXK050079
AS1132	5	10	FLTAS1132	RB1132	R806915	ZCPMK41100SF	ZBRAS1132	BXK041870, BXK043124
AS1133	6	10	—	RB1133	R806916	ZCPMK41106S	ZBRAS1133	BXK041876, BXK043134
AS1134	6.5	10	—	RB1134	R806917	ZCPMK41101S	ZBRAS1134	—
AS1135	—	10	—	RB1135	R806918	ZCPMK24103S	ZBRAS1135	—
AS1136	5.5	10	—	RB1136	R806919	ZCPMK44100S	ZBRAS1136	BXK041871, BXK102277
AS1137	5	24	—	RB1137	R806920	ZCPMK25103S	ZBRAS1137	BXK046175
AS1138	5.5	24	—	RB1138	R806921	ZCPMK45100SF	ZBRAS1138	BXK051467, BXK051512
AS1139	5	28	—	RB1139	R806922	ZCPMK22103S	ZBRAS1139	BXK047150
AS1140	—	—	FLTAS1140, FLTR801073	RB1140	R806900	ZCPMK42100SF	ZBRAS1140	BXK034076, BXK043197
AS1141	—	—	FLTAS1141	RB1141	R806901	ZCPMK42106S	ZBRAS1141	BXK041877, BXK047457
AS1142	6.5	28	—	RB1142	R806923	ZCPMK42101S	ZBRAS1142	—
AS1143	5.5	37	—	RB1143	R806924	ZCPMK43100S	ZBRAS1143	BXK102369
AS1144	6	37	—	RB1144	R806925	ZCPMK43106S	ZBRAS1144	BXK102371
AS1146	5.5	10	—	RB1146	R806927	ZCPMK41100S	ZBRAS1146	BXK041870, BXK043124
AS1147	6	10	—	RB1147	R806928	ZCPMK41106S	ZBRAS1147	BXK041876
AS1148	6.5	10	—	RB1148	R806929	ZCPMK41101S	ZBRAS1148	—
AS1149	5.5	28	—	RB1149	R806930	ZCPMK42100S	ZBRAS1149	BXK034076, BXK043197
AS1150	6	28	—	RB1150	R806931	ZCPMK42106S	ZBRAS1150	BXK041877, BXK047457
AS1151	6.5	28	—	RB1151	R806932	ZCPMK42101S	ZBRAS1151	—
AS1152	5.5	10	—	RB1152	R806933	ZCPMK34400S	ZBRAS1152	—
AS1153	5.5	10	—	RB1153	R806934	ZCPMK44300S	ZBRAS1153	—
AS1154	5.5	24	—	RB1154	R806935	ZCPMK35400S	ZBRAS1154	—
AS1155	—	—	—	RB1155	—	ZCPMK45300S	ZBRAS1155	—
AS1156	5.5	10	—	RB1156	R806936	ZCPMK41300S	ZBRAS1156	BXK102425



DRUM BRAKE



NEW SHOE KITS

TYPE	FMSI	GAWR	FLEETRITE X-REF	MERITOR EG X-REF	FLEETRITE PRO X-REF	MERITOR MG X-REF	MERITOR GENUINE X-REF	BENDIX X-REF
Economy	4707	20	FLT4707QP20KN	KEG4707QP	FLTPRO4707QP20KN	KMG14707QP	KSMA2124707QP	BXSB4707QBB200
Economy	4707	23	FLT4707QP23KN	KEG24707QP	FLTPRO4707QP23KN	KMG2L4707QP	KSMA2124707QP	BXSB4707QBB230
Economy	4709	20	FLT4709E220KN	KEG4709ES2	FLTPRO4709E220KN	KMG14709ES2	KSMA2124709E1	—
Economy	4709	23	FLT4709E223KN	KEG24709E2	FLTPRO4709E223KN	KMG2L4709ES2	KSMA3124709E2	—
Economy	4711	20	—	KEG4711QP	—	KMG14711QP	KSMA2124711QP	—
Economy	4711	23	—	KEG24711QP	FLTPRO4711QP23KN	KMG2L4711QP	KSMA3124711QP	—
Economy	4720	20	FLT4720QP20KN	KEG4720QP	FLTPRO4720QP20KN	KMG14720QP	KSMA2124720QP	—
Economy	4720	23	FLT4720QP23KN	KEG24720QP	FLTPRO4720QP23KN	KMG2L4720QP	KSMA3124720QP	—
Economy	4515	20	—	KEG4515Q	—	KMG14515Q	KSMA2124515Q	BXSB4515QBB200
Economy	4515	23	FLT4515Q23KN	KEG24515Q	—	KMG2L4515Q	KSMA3124515Q	BXSB4515QBB230
Economy	4702	20	FLT4702QP20KN	—	FLTPRO4702QP20KN	KMG24702QP	KSMA2124702QP	BXSB4702QBB200
Economy	4702	23	FLT4702QP23KN	KEG24702QP	FLTPRO4702QP23KN	KMG2L4702QP	KSMA3124702QP	BXSB4702QBB230
Economy	4726	20	FLT4726E20KN	KEG4726E	FLTPRO4726E20KN	KMG14726E	KSMA2124726E	—
Economy	4726	23	FLT4726E23KN	KEG24726E	FLTPRO4726E23KN	KMG2L4726E	KSMA3124726E	—
Economy	4715	20	FLT4715QP20KN	—	FLTPRO4715QP20KN	—	KSMA20014715QP	—
Economy	4715	23	FLT4715QP23KN	—	FLTPRO4715QP23KN	KMG24715QP	KSMA23014715QP	—
Economy	4311	20	—	KEG4311E	FLTPRO4311E20KN	KMG14311E	KSMA2124311E	BXSB4311EBB200
Economy	4311	23	—	—	FLTPRO4311E23KN	KMG24311E	KSMA3124311E	BXSB4311EBB230
Economy	1443	20	FLT1443E20KN	—	FLTPRO1443E20KN	—	KSMA2121443E	BXSB1443EBB200
Economy	1443	23	FLT1443E23KN	—	FLTPRO1443E23KN	KMG2L1443E	KSMA3121443E	BXSB1443EBB230
Economy	4710	20	FLT4710QP20KN	—	FLTPRO4710QP20KN	—	KSMA2124710QP	—
Economy	4710	23	FLT4710QP23KN	—	FLTPRO4710QP23KN	—	KSMA3124710QP	—
Economy	4719	20	—	—	FLTPRO4719E20KN	KMG14719E	KSMA2124719E	—
Economy	4719	23	—	—	—	—	KSMA3124719E	—



REMAN SHOE KITS

TYPE	FMSI	GAWR	FLEETRITE X-REF	MERITOR EG X-REF	FLEETRITE PRO X-REF	MERITOR MG X-REF	MERITOR GENUINE X-REF	BENDIX X-REF
Economy	4707	20	FLT4707QP20K	XKEG4707QP	FLTPRO4707QP20K	XKMG14707QP	XK2124707QP	BXKT4707QBB200
Economy	4707	23	FLT4707QP23K	XKEG24707QP	FLTPRO4707QP23K	XKMG2L4707QP	XK3124707QP	BXKT4707QBB230
Economy	4709	20	FLT4709E220K	XKEG4709ES2	FLTPRO4709E220K	XKMG14709ES2	XK2124709E1	—
Economy	4709	23	FLT4709E223K	XKEG24709E2	FLTPRO4709E223K	XKMG2L4709ES2	XK3124709E1	—
Economy	4711	20	—	XKEG4711QP	—	XKMG14711QP	XK2124711QP	—
Economy	4711	23	—	XKEG24711QP	FLTPRO4711QP23K	XKMG2L4711QP	XK3124711QP	—
Economy	4720	20	FLT4720QP20K	XKEG4720QP	FLTPRO4720QP20K	XKMG14720QP	XK2124720QP	—
Economy	4720	23	FLT4720QP23K	XKEG24720QP	FLTPRO4720QP23K	XKMG2L4720QP	XK3124720QP	—
Economy	4515	20	—	XKEG4515Q	—	XKMG14515Q	XK2124515Q	BXKT4515QBB200
Economy	4515	23	FLT4515Q23K	XKEG24515Q	—	XKMG2L4515Q	XK3124515Q	BXKT4515QBB230
Economy	4702	20	FLT4702QP20K	XKEG4702QP	FLTPRO4702QP20K	XKMG24702QP	XK2124702QP	BXKT4702QBB200
Economy	4702	23	FLT4702QP23K	XKEG24702QP	FLTPRO4702QP23K	XKMG2L4702QP	XK3124702QP	BXKT4702QBB230
Economy	4726	20	FLT4726E20K	XKEG4726E	FLTPRO4726E20K	XKMG14726E	XK2124726E	—
Economy	4726	23	FLT4726E23K	XKEG24726E	FLTPRO4726E23K	XKMG2L4726E	XK3124726E	—
Economy	4715	20	FLT4715QP20K	XKEG4715QP	FLTPRO4715QP20K	XKMG24715QP	XK2124715QP	—
Economy	4715	23	FLT4715QP23K	XKEG24715QP	FLTPRO4715QP23K	XKMG2L4715QP	XK3124715QP	—
Economy	4311	20	—	XKEG4311E	FLTPRO4311E20K	XKMG24311E	XK2124311E	BXKT4311EBB200
Economy	4311	23	—	XKEG24311E	FLTPRO4311E23K	XKMG2L4311E	XK3124311E	BXKT4311EBB230
Economy	1443	20	FLT1443E20K	—	FLTPRO1443E20K	XKMG21443E	XK2121443E	BXKT1443EBB200
Economy	1443	23	FLT1443E23K	—	FLTPRO1443E23K	XKMG2L1443E	XK3121443E	BXKT1443EBB230
Economy	4710	20	FLT4710QP20K	XKEG4710QP	FLTPRO4710QP20K	XKMG24710QP	XK2124710QP	—
Economy	4710	23	FLT4710QP23K	XKEG24710QP	FLTPRO4710QP23K	XKMG2L4710QP	XK3124710QP	—
Economy	4719	20	—	XKEG4719E	FLTPRO4719E20K	XKMG24719E	XK2124719E	—
Economy	4719	23	—	XKEG24719E	—	XKMG2L4719E	XK3124719E	—



DRUM BRAKE (CONT'D)



ABEX SHOE KITS

FRICITION	GAWR	4707	4709	4515	4702	4720	4711	4719
6008	20K	FLTEN4707QPK	FLTEN4709E2K	FLTEN4515QK	FLTEN4702QPK	FLTEN4720QPK	FLTEN4711QPK	FLTEN4719E2K
6011	20K	FLTEL4707QPK	FLTEL4709E2K	—	FLTEL4702QPK	FLTEL4720QPK	—	—
6230 - RSD Cert	20K	FLTRN4707QPK	FLTRN4709E2K	FLTRN4515QK	FLTRN4702QPK	FLTRN4720QPK	FLTRN4711QPK	FLTRN4719E2K
685	23K	FLTEX4707QPK	FLTEX4709E2K	FLTEX4515QK	FLTEX4702QPK	FLTEX4720QPK	FLTEX4711QPK	FLTEX4719E2K
6098 - Severe Service	23K	FLTSD4707QPK	FLTSD4709E2K	FLTSD4515QK	—	FLTRX4720QPK	FLTSD4711QPK	—
6297 - RSD Cert	23K	FLTRX4707QPK	FLTRX4709E2K	FLTRX4515QK	FLTRX4702QPK	FLTSD4720QPK	FLTRX4711QPK	FLTRX4719E2K



Contact your local dealer for additional FMSI options.

RSD BRAKE SHOE KITS

TYPE	FMSI	GAWR	FLEETRITE X-REF	MERITOR X-REF	BENDIX X-REF
RSD	4707	20	FLTRSD4707QP20K	XK20014707QP	BXSB4707QBA202R
RSD	4707	23	FLTRSD4707QP23K	XK23014707QP	BXSB4707QBA232R
RSD	4709	20	FLTRSD4709E220K	XK20014709E2	BXSB4709E2BA202R
RSD	4709	23	FLTRSD4709E223K	XK23014709E2	BXSB4709E2BA232R
RSD	4711	20	FLTRSD4711QP20K	XK20014711QP	BXSB4711QBA202R
RSD	4711	23	—	XK23014711QP	BXSB4711QBA232R
RSD	4720	14.6	FLTRSD4720QP12K	XK15024720QP	BXSB4720QBA202R
RSD	4515	20	FLTRSD4515Q23K	XK20014515Q	—
RSD	4515	23	FLTRSD4515Q23K	—	—
RSD	4702	20	—	XK20014702QP	—
RSD	4702	23	—	XK23014702QP	—
RSD	4726	20	FLTRSD4726E20K	XK20014726E	BXSB4726E2BA202R
RSD	4726	23	—	XK23014726E	BXSB4726E2BA232R
RSD	4715	20	—	XK20014715QP	—
RSD	4715	23	—	XK23014715QP	—
RSD	4311	20	—	—	—
RSD	4311	23	—	—	—
RSD	1443	20	—	XK20011443E	—
RSD	1443	23	—	—	—
RSD	4710	20	—	—	—
RSD	4710	23	—	—	—
RSD	4719	20	FLTRSD4719E20K	XK20014719E	BXSB4719E2BA202R
RSD	4719	23	—	XK23014719E	BXSB4719E2BA232R

SHOES, INDIVIDUAL

TYPE	FMSI	GAWR	MERITOR X-REF	MID GRADE MERITOR X-REF	FLEETRITE ABEX RSD X-REF
Economy	4707	20	SEG24707QP	SMG14707QP	FLTRN4707QP
Economy	4707	23	SEG24707QP	SMG2L4707QP	FLTRX4707QP
Economy	4709	20	SEG4709ES2	SMG14709ES2	FLTRN4709E2
Economy	4709	23	SEG24709E2	SMG2L4709ES2	FLTRX4709E2
Economy	4711	20	SEG4711QP	SMG14711QP	FLTRN4711QP
Economy	4711	23	SEG24711QP	SMG2L4711QP	FLTRX4711QP
Economy	4720	20	SEG4720QP	SMG14720QP	FLTRN4720QP
Economy	4720	23	SEG24720QP	SMG2L4720QP	FLTRX4720QP
Economy	4515	20	—	SMG14515Q	—
Economy	4515	23	—	SMG2L4515Q	FLTRX4515Q
Economy	4702	20	—	SMG14702QP	—
Economy	4702	23	—	—	FLTRX4702QP
Economy	4726	20	SEG4726E	SMG14726E	—
Economy	4726	23	SEG24726E	SMG2L4726E	—
Economy	4715	20	—	—	—
Economy	4715	23	—	—	—
Economy	4311	20	—	—	—
Economy	4311	23	—	—	—
Economy	1443	20	—	—	—

DRUM BRAKE (CONT'D)



SHOES, INDIVIDUAL (CONT'D)

TYPE	FMSI	GAWR	MERITOR X-REF	MID GRADE MERITOR X-REF	FLEETRITE ABEX RSD X-REF
Economy	1443	23	—	—	—
Economy	4710	20	—	—	—
Economy	4710	23	—	—	—
Economy	4719	20	SEG4719E	SMG14719E	—
Economy	4719	23	SEG24719E	SMG2L4719E	FLTRX4719E2

HARDWARE KITS

PN	APPLICATION	FLEETRITE X-REF	MERITOR X-REF
KIT8000HD	Meritor, Rockwell Dana Hendrickson Q Brake, New OE Retainer	FLTBHK8000HD	KIT8000HD
KIT8081	Meritor, Rockwell 16.5" Steer Axle Brake	FLTBHK8081	KIT8081
KIT8824HD	Meritor, Rockwell 15" Front Q Plus Brake, Complete Kit	FLTBHK8824HD	KIT8824HD
KIT8078A	Meritor, Camshaft Kits	FLTBHK8078	KIT8078A
KIT9081	Meritor, Kit Anchor Pin	FLTBHK9081	KIT9081
KIT8042SB	Meritor, Camshaft Kits	FLTBHK8042	KIT8042SB
KIT9179	Meritor, Brake Hardware Kits	FLTBHK9179	KIT9179
KIT8000	Meritor, Brake Hardware Kits E-2768, Return Spring	FLTBHK8000	KIT8000
R507094	Eaton, Eaton 16.5" Esii Extended Service, Front Axle Brake	FLTBHK507094	R507094
R507064	Eaton, Eaton 16.5" Extended Service Brake, Second Generation	FLTBHK507064	R507064
KIT8846HD	Meritor, Brake Hardware Kits	FLTBHK8846HD	KIT8846HD
MKT4515QHDK	Meritor, Rockwell Dana Hendrickson Q Brake, New OE Retainer	FLTBHK4515Q	MKT4515QHDK



CAMSHAFTS AND HARDWARE KITS



CAMSHAFT, LH

PN	DESCRIPTION	MERITOR X-REF	BENDIX X-REF	RANGER BRAKE X-REF	FLEETRITE X-REF
R607325	1-1/2" 28-Spline, 11-1/32" Length, 1-1/2" Journal Diameter	R607325	—	RBE11866	FLTCS125
R607002	1-1/2" 10-Spline, 23-15/32" Length, 1-1/2" Journal Diameter	R607002	BX17575	—	FLTCS102
R607082	1-1/2" 10-Spline, 20-7/16" Length, 1-1/2" Journal Diameter	R607082	—	—	—
R607183	1-1/2" 28-Spline, 23-9/16" Length, 1-1/2" Journal Diameter	R607183	BX17503	—	—
R607231	1-1/2" 28-Spline, 23-9/16" Length, 1-5/8" Journal Diameter	R607231	BX17929	—	FLTCS131
R607011	1-5/8" 37-Spline, 16-1/8" Length, 1-5/8" Journal Diameter	R607011	BX17621	—	—
R607277	1-1/2" 28-Spline, 24-1/16" Length, 1-5/8" Journal Diameter	R607277	BX17931	—	—
R607177	1-1/2" 10-Spline, 23-1/2" Length, 1-1/2" Journal Diameter	R607177	BX17509	—	—
R607020	1-5/8" 37-Spline, 21-1/8" Length, 1-5/8" Journal Diameter	R607020	BX17623	—	—
R607273	1-1/2" 28-Spline, 23-3/16" Length, 1-5/8" Journal Diameter	R607273	BX17417	—	—
R607319	1-1/2" 28-Spline, 26-1/4" Length, 1-5/8" Journal Diameter	R607319	—	—	—
R607171	1-1/2" 28-Spline, 23-1/2" Length, 1-1/2" Journal Diameter	R607171	BX17483	—	—
R607113	1-1/2" 28-Spline, 23-3/4" Length, 1-1/2" Journal Diameter	R607113	BX976958N	—	—
R607199	1-1/2" 28-Spline, 24-1/16" Length, 1-1/2" Journal Diameter	R607199	BX17515	—	—
R607267	1-1/2" 28-Spline, 11-1/32" Length, 1-1/2" Journal Diameter	R607267	BX1711055	—	—
R607229	1-1/2" 28-Spline, 20-7/16" Length, 1-5/8" Journal Diameter	R607229	BX17921	—	—
R607076	1-1/2" 10-Spline, 11-33/64" Length, 1-1/2" Journal Diameter	R607076	—	—	—
R607227	1-1/2" 28-Spline, 17-7/16" Length, 1-5/8" Journal Diameter	R607227	BX17915	—	—
R607193	1-1/2" 10-Spline, 26-1/2" Length, 1-1/2" Journal Diameter	R607193	BX17593	—	—
R607105	1-1/2" 10-Spline, 11-9/16" Length, 1-1/2" Journal Diameter	R607105	BX18943	—	—



The Right Brake Parts to Keep You on Your Journey

The Meritor® air brake portfolio offers the camshafts and cam kits needed to support complete brake jobs for uptime.

Tech Tip: Check the camshaft for cracks, wear or corrosion. Check the cam head bearing journals and splines. Replace worn or damaged camshafts. Install new bushings and seals whenever you install a new camshaft.

meritorpartsexpress.com



CAMSHAFTS AND HARDWARE KITS (CONT'D)



CAMSHAFT, RH

PN	DESCRIPTION	MERITOR X-REF	BENDIX X-REF	RANGER BRAKE X-REF	FLEETRITE X-REF
R607326	1-1/2" 28-Spline, 11-1/32" Length, 1-1/2" Journal Diameter	R607326	—	—	FLTCS126
R607001	1-1/2" 10-Spline, 23-15/32" Length, 1-1/2" Journal Diameter	R607001	BX17574	RBE1187	FLTCS101
R607081	1-1/2" 10-Spline, 20-7/16" Length, 1-1/2" Journal Diameter	R607081	—	—	—
R607184	1-1/2" 28-Spline, 23-9/16" Length, 1-1/2" Journal Diameter	R607184	BX17502	—	—
R607232	1-1/2" 28-Spline, 23-9/16" Length, 1-5/8" Journal Diameter	R607232	BX17928	—	FLTCS132
R607012	1-5/8" 37-Spline, 16-1/8" Length, 1-5/8" Journal Diameter	R607012	BX17620	—	—
R607278	1-1/2" 28-Spline, 24-1/16" Length, 1-5/8" Journal Diameter	R607278	BX17930	—	—
R607178	1-1/2" 10-Spline, 23-1/2" Length, 1-1/2" Journal Diameter	R607178	BX17508	—	—
R607019	1-5/8" 37-Spline, 21-1/8" Length, 1-5/8" Journal Diameter	R607019	BX17622	—	—
R607274	1-1/2" 28-Spline, 23-3/16" Length, 1-5/8" Journal Diameter	R607274	BX17416	—	—
R607320	1-1/2" 28-Spline, 26-1/4" Length, 1-5/8" Journal Diameter	R607320	—	—	—
R607172	1-1/2" 28-Spline, 23-1/2" Length, 1-1/2" Journal Diameter	R607172	BX17482	—	—
R607114	1-1/2" 28-Spline, 23-3/4" Length, 1-1/2" Journal Diameter	R607114	BX976959N	—	—
R607200	1-1/2" 28-Spline, 24-1/16" Length, 1-1/2" Journal Diameter	R607200	BX17514	—	—
R607268	1-1/2" 28-Spline, 11-1/32" Length, 1-1/2" Journal Diameter	R607268	BX1711056	—	—
R607230	1-1/2" 28-Spline, 20-7/16" Length, 1-5/8" Journal Diameter	R607230	BX17920	—	—
R607075	1-1/2" 10-Spline, 11-33/64" Length, 1-1/2" Journal Diameter	R607075	—	—	—
R607228	1-1/2" 28-Spline, 17-7/16" Length, 1-5/8" Journal Diameter	R607228	BX17914	—	—
R607194	1-1/2" 10-Spline, 26-1/2" Length, 1-1/2" Journal Diameter	R607194	BX17592	—	—
R607106	1-1/2" 10-Spline, 11-9/16" Length, 1-1/2" Journal Diameter	R607106	BX18942	—	—



CAMSHAFT REPAIR KIT

PN	DESCRIPTION	MERITOR X-REF	BENDIX X-REF	FLEETRITE X-REF
KIT8042	Meritor 15" and 16-1/2" Q and Q Plus	KIT8042	BX434047	FLTCSKIT142
KIT8078	Meritor 16-1/2" Q	KIT8078	—	—
R615025	Hendrickson 16-1/2" INTRAAX®	R615025	—	—
KIT8048	Meritor 12-1/4" and 16-1/2" P and Q	KIT8048	BX437037A	FLTCSKIT148
KIT8033	Meritor 16-1/2" P, Q, and Q Plus	KIT8033	—	—
R615008	Spicer and Standard Forge 16-1/2"	R615008	BX437032	—
KIT8883	Meritor 15" and 16-1/2" Q Plus	KIT8883	—	—
KIT9078	Meritor 16-1/2" P	KIT9078	BX437034	—
KIT8033C	Meritor 16-1/2" Q Plus	KIT8033C	—	—
KIT8091	Meritor 16-1/2" P and Q	KIT8091	—	—
R615019	Spicer 16-1/2"	R615019	—	—
R615015	Eaton 15" and 16-1/2"	R615015	BX437069	—
R615002	Eaton 15" and 16-1/2" and 18"	R615002	BX437041	—
R615005	Fruehauf (Propar) 12-1/4" and 16-1/2"	R615005	BX437039	—
KIT8058	Meritor 16-1/2" P and Q	KIT8058	BX437071	—



Built for Unsurpassed Performance on the Road

Meritor®'s STEELite X30™ brake drum is the industry leader, combining weight savings and strength for increased payload and fuel economy. The maximum allowable brake drum diameter is stamped or cast into the outer edge of the drum. Place a brake drum diameter gauge inside the drum.

Tech Tip: Take several measurements within 90 degrees of each other at the open and closed edges of the drum's friction surface. If any of these measurements are 0.120-inch, replace the brake drum. If a brake drum is out-of-round, replace the drum.

meritorpartsxpress.com



BRAKE DRUMS



STANDARD DRUMS

PN	DIMENSIONS	FLEETRITE X-REF	INTERNATIONAL X-REF	GUNITE X-REF	WEBB X-REF	MOTOR WHEEL X-REF	CONMET X-REF
3887	12.25" x 7"	—	—	ZBR3887	W63680F	—	—
3721AX	15" x 4"	FLT4421B	2605074C1	ZBR3721AX	W61528B	—	CNM10081828
3800X	15" x 4"	FLT4480B	2605075C1	ZBR3800X	W65545B	MW89870BK	CNM10009920
3710X	16.5" x 5"	FLT4410B	4115968C1	ZBR3710X	W65710B	MW90137B	CNM10020147
3922X	16.5" x 7"	FLT4400B, FLT4401B	4115966C1	ZBR3922X	W56864B	MW89996B	CNM10009830
3600AX	16.5" x 7"	—	2605072C1	ZBR3600AX	W66864B	MW89996B	CNM10009830
3807AX	16.5" x 8.62"	FLT4407B	4115969C1	ZBR3807AX	W66854B	MW600026	CNM10012097



LIGHTWEIGHT DRUMS

PN	DIMENSIONS	FLEETRITE X-REF	INTERNATIONAL X-REF	GUNITE X-REF	WEBB X-REF	MOTOR WHEEL X-REF	CONMET X-REF	MERITOR X-REF
3887	12.25" x 7"	—	—	ZBR3887	W63680F	—	—	—
3721AX	15" x 4"	—	—	ZBR3721AX	W95548B	MW89870BK	CNM10001783	53123542002
3758X	16.5" x 5"	FLTSLWD1655	2603638C1	ZBR3758X	W95151B	MW90600B	CNM10041523	53123815002
3600AX	16.5" x 7"	FLTSLWD1657	4098040C1	ZBR3600AX	W96864B	MW89996B	CNM10037763	53123537002
3807AX	16.5" x 8.62"	FLTSLWD165862	3503500C4	ZBR3807AX	W96854B	MW600026	CNM10037825	53123544002

SEVERE SERVICE DRUMS

PN	DIMENSIONS	INTERNATIONAL X-REF	GUNITE X-REF	WEBB X-REF	MOTOR WHEEL X-REF	CONMET X-REF
3887	12.25" x 7"	—	ZBR3887	W63680F	—	—
3721AX	15" x 4"	2605074C1	ZBR3721AX	W61528B	MW90089BK	—
3710X	16.5" x 5"	4115968C1	ZBR3710X	W77805BW	MW90137B	CNM10020147
3600AX	16.5" x 7"	1670176C3	ZBR3600AX	W66884B	MW89996B	CNM10037819
3811X	16.5" x 8.62"	4115969C1	ZBR3811X	W64126B	MW600026	CNM10037830

HIGH PERFORMANCE DRUMS

PN	DIMENSIONS	WEBB X-REF	CONMET X-REF
63680	12.25" x 7"	W63680F	—
77528	15" x 4"	W77528B	CNM10081828
77805	16.5" x 5"	W77805BW	CNM10020147
77807	16.5" x 7"	W77807BW	CNM10009830
77809	16.5" x 8.62"	W77809BW	CNM10012097

STANDARD TO VORTEX CRT

16.5" x 5" : 65710B > 77805BW

16.5" x 7" : 66864B > 77807BW

16.5" x 8" : 66800B > 77808BW

16.5" x 8.62" : 66854B > 77809BW

CRT
Coastal Rim Technology

WHEELS



ALUMINUM

PN	DESCRIPTION	DIMENSIONS	HUB/STUD PILOTED	FINISH	FLEETRITE X-REF	ACCURIDE X-REF
42644XP	285.75mm Bolt Circle, 10-Bolt Hole	22.5" x 8.25"	Hub, Dual Mounting	Extra Polish	FLTAW225825XP	A42644XP
43644SP	285.75mm Bolt Circle, 10-Bolt Hole	22.5" x 8.25"	Hub, Dual Mounting	Standard Polish	FLTAW225825SP	A43644SP
42362XP	285.75mm Bolt Circle, 10-Bolt Hole	24.5" x 8.25"	Hub, Dual Mounting	Extra Polish	FLTLAW225825XP	A42362XP
42644XPC	285.75mm Bolt Circle, 10-Bolt Hole	22.5" x 8.25"	Hub, Dual Mounting	Extra Polish with Accu-Shield®	—	A42644XPC
42362XPC	285.75mm Bolt Circle, 10-Bolt Hole	24.5" x 8.25"	Hub, Dual Mounting	Extra Polish with Accu-Shield®	—	A42362XPC
42362SP	285.75mm Bolt Circle, 10-Bolt Hole	24.5" x 8.25"	Hub, Dual Mounting	Standard Polish	FLTLAW225825SP	A42362SP
27599XP	11-1/4" Bolt Circle, 10-Bolt Hole	24.5" x 8.25"	Stud, Dual Mounting	Extra Polish	—	A27599XP
28632XP	11-1/4" Bolt Circle, 10-Bolt Hole	22.5" x 8.25"	Hub, Dual Mounting	Extra Polish	—	A28632XP
27599SP	11-1/4" Bolt Circle, 10-Bolt Hole	24.5" x 8.25"	Stud, Dual Mounting	Standard Polish	—	A27599SP
28632SP	11-1/4" Bolt Circle, 10-Bolt Hole	22.5" x 8.25"	Hub, Dual Mounting	Standard Polish	—	A28632SP
29685XP	285.75mm Bolt Circle, 10-Bolt Hole	19.5" x 7.5"	Hub, Dual Mounting	Extra Polish	—	A29685XP
29685SP	285.75mm Bolt Circle, 10-Bolt Hole	19.5" x 7.5"	Hub, Dual Mounting	Standard Polish	—	A29685SP
29695XP	275mm Bolt Circle, 8-Bolt Hole	19.5" x 6.7"	Hub, Dual Mounting	Extra Polish	—	A29695XP
29695SP	275mm Bolt Circle, 8-Bolt Hole	19.5" x 6.75"	Hub, Dual Mounting	Standard Polish	—	A29695SP
40018XP	225mm Bolt Circle, 10-Bolt Hole	19.5" x 6"	Hub, Dual Mounting	Extra Polish	—	A40018XP
40018SP	225mm Bolt Circle, 10-Bolt Hole	19.5" x 6"	Hub, Dual Mounting	Standard Polish	—	A40018SP



STEEL

PN	DESCRIPTION	DIMENSIONS	HUB/STUD PILOTED	FLEETRITE X-REF	ACCURIDE X-REF
51408	Accu-Lite® ESW 22.5" x 8.25" 2 HH, Steel Armor™ Powder White	22.5" x 8.25"	Hub	FLTSW225825H2	A51408PKWHT21
51487	Accu-Lite® ESW 22.5" x 8.25" 5 HH, Powder White	22.5" x 8.25"	Hub	FLTSW225825H5	A51487PKWHT21
27404	ESW 22.5" x 8.25" 2 HH, Steel Armor™ Powder White	22.5" x 8.25"	Stud	FLTSW225825S2	A27404PKWHT21
27833C	ESW 22.5" x 8.25" 5 HH, Steel Armor™ Powder White	22.5" x 8.25"	Stud	—	A27833CPKWHT21
50409	ESW Accu-Lite® 24.5" x 8.25" 2 HH, Steel Armor™ Powder White	24.5" x 8.25"	Hub	FLTSW245825H2	A50409PKWHT21
50641	ESW Accu-Lite® 24.5" x 8.25" 5 HH, Steel Armor™ Powder White	24.5" x 8.25"	Hub	FLTSW245825H5	A50641PKWHT21
27406	ESW 24.5" x 8.25" 2 HH, Steel Armor™ Powder White	24.5" x 8.25"	Stud	FLTSW245825S2	A27406PKWHT21
28827	ESW 24.5" x 8.25" 2 HH, Steel Armor™ Powder White	24.5" x 8.25"	Hub	—	A28827PKWHT21
28440	Ultramount 22.5" x 8.25" 10 HH, Steel Armor™ Powder White	22.5" x 8.25"	Hub	—	A28440PKWHT21
28828	ESW 22.5" x 8.25" 2 HH, Steel Armor™ Powder White	22.5" x 8.25"	Hub	—	A28828PKWHT21
50180	LTK 19.5" x 6.75" RW 4 HH, Powder White	19.5" x 6.75"	Hub	—	A50180PKWHT21
29884BV	LTK 19.5" x 6.00" RW 5 HH, Powder White	19.5" x 6"	Hub	—	A29884BVPKWHT21
29300	ESW 22.5" x 9.00" 5 HH, Powder White	22.5" x 9"	Hub	—	A29300PKWHT21
29169	ESW-29169 22.5" x 8.25" Steel Armor™ Powder White	22.5" x 8.25"	Hub	—	A29169PKWHT21
29195	ESW 19.5" x 7.50" RW 5 HH, Steel Armor™ Powder White	19.5" x 7.5" RW	Hub	—	A29195PKWHT21
29001	ESW 22.5" x 7.50" 5 HH, Steel Armor™ Powder White	22.5" x 7.5"	Hub	—	A29001PKWHT21
29807	Duplex® 22.5" x 12.25" 5 HH, Powder White	22.5" x 12.2"	Hub	—	A29807PKWHT21
29039	ESW 22.5" x 9.00" 5 HH, Steel Armor™ Powder White	22.5" x 9"	Hub	—	A29039PKWHT21
50593	22.5" x 9.00" RW 10 HH, Powder Grey	22.5" x 9" Euro	Hub	—	A50593PKGRY21



For optional Accuride paint colors, substitute (Powder) White with Black, Grey, Yellow or Red.



Fleetrite® Tubeless Aluminum Wheels in Popular Sizes

Fleetrite offers tubeless aluminum wheels in two of the most popular sizes — 22.5" x 8.25" and 24.5" x 8.25". These aluminum wheels are one of the lightest weighing wheels to help improve fuel economy and increase payload, which means big savings for on-highway applications. The single-piece metal reduces vibration, cutting down on tire wear.

fleetrite.com



HUBS



STANDARD HUBS

PN	AXLE	APPLICATION	CONMET X-REF
10082251	Conventional Trailer, Iron Hub, Short Stud, 23K GAWR, 11.5K Load Rating	TN Trailer Spindle Drum Brakes	CNM10082251
10082252	Conventional Trailer, Iron Hub, Long Stud, 23K GAWR, 11.5K Load Rating	TN Trailer Spindle Drum Brakes	CNM10082252
10082255	Conventional Trailer, Iron Hub, Short Stud, 25K GAWR, 12.5K Load Rating	TP Trailer Spindle Drum Brakes	CNM10082255
10082256	Conventional Trailer, Iron Hub, Long Stud, 25K GAWR, 12.5K Load Rating	TP Trailer Spindle Drum Brakes	CNM10082256
10082249	Conventional Trailer, Aluminum Hub, Short Stud, 23K GAWR, 11.5K Load Rating	TN Trailer Spindle Drum Brakes	CNM10082249
10082250	Conventional Trailer, Aluminum Hub, Long Stud, 23K GAWR, 11.5K Load Rating	TN Trailer Spindle Drum Brakes	CNM10082250
10082253	Conventional Trailer, Aluminum Hub, Short Stud, 25K GAWR, 12.5K Load Rating	TP Trailer Spindle Drum Brakes	CNM10082253
10082254	Conventional Trailer, Aluminum Hub, Long Stud, 25K GAWR, 12.5K Load Rating	TP Trailer Spindle Drum Brakes	CNM10082254



PRESET HUBS

PN	AXLE	APPLICATION	CONMET X-REF	STEMCO X-REF
10082201	FF Front Axle, Aluminum Hub, Long Stud, 13.2K GAWR, 6.6K Load Rating	Freightliner, Western Star, Sterling Volvo (5.44 Offset Drum Brakes)	CNM10082201	ZCP4530236, ZCP4530237
10082207	FF Front Axle, Aluminum Hub, Long Stud, 13.2K GAWR, 6.6K Load Rating	Kenworth, Peterbilt, International, Mack (5.06 Offset Drum Brakes)	CNM10082207	ZCP4532236, ZCP4532237
10082209	FF Front Axle, Aluminum Hub, Long Stud, 14.6K GAWR, 7.3K Load Rating	Kenworth, Peterbilt, International, Mack (5.06 Offset Drum Brakes)	CNM10082209	ZCP4532236, ZCP4532237
10082213	FL Front Axle, Aluminum Hub, Long Stud, 20K GAWR, 10K Load Rating	ALL OEMs (4.29 Offset Drum Brakes)	CNM10082213	ZCP4530264
10082215	FL Front Axle, Iron Hub, Long Stud, 23K GAWR, 11.5K Load Rating	ALL OEMs (4.29 Offset Drum Brakes)	CNM10082215	ZCP4530264
10082217	Rear Axle, Aluminum Hub, Long Stud, 23K GAWR, 11.5K Load Rating	Freightliner, Western Star, Kenworth, Peterbilt, Sterling, Mack (Long Barrel Drum Brakes)	CNM10082217	ZCP4530273
10082218	Rear Axle, Iron Hub, Short Stud, 26K GAWR, 13K Load Rating	Freightliner, Western Star, Kenworth, Peterbilt, Sterling, Mack (Long Barrel Drum Brakes)	CNM10082218	ZCP4530273
10082219	Rear Axle, Iron Hub, Long Stud, 26K GAWR, 13K Load Rating	Freightliner, Western Star, Kenworth, Peterbilt, Sterling, Mack (Long Barrel Drum Brakes)	CNM10082219	ZCP4530273
10082221	Rear Axle, Aluminum Hub, Long Stud, 23K GAWR, 11.5K Load Rating	Volvo, International (Short Barrel Drum Brakes)	CNM10082221	—
10082225	TN Axle, Aluminum Hub, Long Stud, 23K GAWR, 11.5K Load Rating	Trailer Tapered Spindle Drum Brakes	CNM10082225	—
10082227	TN Axle, Iron Hub, Long Stud, 23K GAWR, 11.5K Load Rating	Trailer Tapered Spindle Drum Brakes	CNM10082227	—
10082229	TP Axle, Aluminum Hub, Long Stud, 25K GAWR, 12.5K Load Rating	Trailer Straight Spindle Drum Brakes	CNM10082229	—
10082231	TP Axle, Iron Hub, Long Stud, 25K GAWR, 12.5K Load Rating	Trailer Straight Spindle Drum Brakes	CNM10082231	—



SEALS, BEARINGS, HUBCAPS



SEALS

PN	APPLICATION	FLEETRITE X-REF	SKF X-REF	NATIONAL SEAL X-REF	STEMCO GRIT GUARD® X-REF	STEMCO GUARDIAN® X-REF	STEMCO VOYAGER® X-REF	STEMCO DISCOVER® X-REF	CONMET X-REF
3080836	Steer 8K	FLTWS35058	CR35058	V370001A	ZCP3828036	ZCP3080836	ZCP3730136	ZCP3830236	CNM10045885
3080836	Steer FF 12K	FLTWS35058	CR35066	V370001A	ZCP3828036	ZCP3080836	ZCP3730136	ZCP3730236	CNM10045883
3070723	Trailer	FLTWS42627	CR42623	V370065A	ZCP3727099	ZCP3070723	ZCP3730123	ZCP3730223	CNM10045889
3070723	Trailer P 22K	FLTWS42627	CR42627	V370065A	ZCP3727099	ZCP3070723	ZCP3730123	ZCP3730223	—
3070743	Trailer	FLTWS47691	CR46300	V370025A	ZCP3727097	ZCP3070743	ZCP3730143	ZCP3730243	—
3070743	Trailer	FLTWS47691	CR46305	V370025A	ZCP3727097	ZCP3070743	ZCP3730143	ZCP3730243	CNM10045888
3090973	Trailer N 22.5K	—	CR47691	—	ZCP3929131	ZCP3090973	ZCP3930173	ZCP3930273	—
3090973	Drive	—	CR47697	—	ZCP3929131	ZCP3090973	ZCP3930173	ZCP3930273	CNM10045887



SEALS, BEARINGS, HUBCAPS (CONT'D)



BEARINGS

PN	DESCRIPTION	APPLICATION	FLEETRITE X-REF	SKF X-REF	GENERAL BEARING/ HYATT X-REF	NTN X-REF	TIMKEN X-REF	AMSTEAD SEAL X-REF	STEMCO X-REF	CONMET X-REF
SET401	Outer Bearing Set 580, 572	Tractor Drive	FLTSET401	SKFSET401	HYTSET401	BWRSET401	TMSET401	TSDR00U01	ZCPSTMSET401	CNM10041916
SET403	Inner Bearing Set 592A, 594A	Tractor Drive	FLTSET403	SKFSET403	HYTSET403	BWRSET403	TMSET403	TSDR00N01	ZCPSTMSET403	CNM10041915
SET404	Inner Bearing Set 598A, 592A	Tractor Drive	—	SKFSET404	HYTSET404	BWRSET404	TMSET404	—	ZCPSTMSET404	—
SET405	Inner Bearing Set 663, 653	Trailer	—	SKFSET405	HYTSET405	BWRSET405	TMSET405	TSTN00N02	ZCPSTMSET405	—
SET406	Outer Bearing Set 3782, 3720	Tractor Steer	FLTSET406	SKFSET406	HYTSET406	BWRSET406	TMSET406	TSFF00U01	ZCPSTMSET406	CNM10041906
SET408	Outer Bearing Set 39590, 39520	Tractor Drive	FLTSET408	SKFSET408	HYTSET408	BWRSET408	TMSET408	TSDL00U01	—	—
SET411	Inner Bearing Set 47686, 47620	Tractor Drive	—	SKFSET411	HYTSET411	BWRSET411	TMSET411	—	—	—
SET412	Inner Bearing Set HM212047, HM212011	Tractor Steer	—	SKFSET412	HYTSET412	BWRSET412	TMSET412	TSFF00N02	ZCPSTMSET412	—
SET413	Outer Bearing Set HM212049, HM212011	Trailer	FLTSET413	SKFSET413	HYTSET413	BWRSET413	TMSET413	TSTN00U01	ZCPSTMSET413	CNM10041905
SET414	Inner Bearing Set HM218248, HM218210	Trailer	FLTSET414	SKFSET414	HYTSET414	BWRSET414	TMSET414	TSTN00N01	ZCPSTMSET414	CNM10041935
SET415	Inner Bearing Set HM518445, HM518410	Trailer	FLTSET415	SKFSET415	HYTSET415	BWRSET415	TMSET415	TSTP00C01	ZCPSTMSET415	CNM10041945
SET421	Inner Bearing Set HM516449A, HM516410	Tractor Drive	—	SKFSET421	HYTSET421	BWRSET421	TMSET421	TSDM00N01	ZCPSTMSET421	—
SET423	Inner Bearing Set 6461A, 6420	Tractor Steer	—	SKFSET423	HYTSET423	BWRSET423	TMSET423	TSFL00N01	ZCPSTMSET423	CNM10041925
SET424	Outer Bearing Set 555S, 552A	Tractor Steer	—	SKFSET424	HYTSET424	BWRSET424	TMSET424	TSFL00U01	ZCPSTMSET424	CNM10041926
SET426	Outer Bearing Set 47679, 47620	Tractor Drive	—	SKFSET426	HYTSET426	BWRSET426	TMSET426	—	ZCPSTMSET426	—



HUBCAPS

PN	APPLICATION	INTERNATIONAL X-REF	SKF X-REF	STEMCO X-REF	AMSTEAD SEAL X-REF
3004009	Trailer	—	—	ZCP3004009	—
3404013	Trailer	3529716C1	CR1642	ZCP3404013	—
3404024	Steer	2519529C91	CR1612	ZCP3404024	TS81042
3404036	Steer	—	CR1702	ZCP3404036	—
3404042	Steer	—	CR1665	ZCP3404042	—
3404046	Steer	—	CR1643	ZCP3404046	TS80046
3404095	Steer	—	CR1642	ZCP3404095	—
3404149	Steer	—	—	ZCP3404149	—
3404195	Trailer	—	CR1696	ZCP3404195	TS80159
3404249	Steer	—	CR1613	ZCP3404249	TS80949
3434009	Trailer	2519531C91	CR1608	ZCP3434009	—
3434024	Steer	2519529C91	CR1612	ZCP3434024	—
3434249	Steer	—	CR1613	ZCP3434249	TS81949

TIRE INFLATION



RETROFIT KITS

PN	DESCRIPTION	STEMCO X-REF
340-4370	MTIS-Ready Hubcap, Grease	ZCP3404370
343-4370	MTIS-Ready Hubcap, Oil	ZCP3434370
343-4374	MTIS-Ready Hubcap, Oil with Magnetic Pipe Plug	ZCP3434374
340-4371	MTIS-Ready Hubcap, Grease	ZCP3404371
343-4371	MTIS-Ready Hubcap, Oil	ZCP3434371
343-4375	MTIS-Ready Hubcap, Oil with Magnetic Pipe Plug	ZCP3434375
340-4372	MTIS-Ready Hubcap, Grease	ZCP3404372
343-4372	MTIS-Ready Hubcap, Oil	ZCP3434372
343-4376	MTIS-Ready Hubcap, Oil with Magnetic Pipe Plug	ZCP3434376
343-4384	MTIS-Ready Hubcap, Grease	ZCP3434384



AXLE NUTS



AXLE SPINDLE NUTS

PN	DESCRIPTION	THREAD SIZE	AXLE	APPLICATION	CONMET X-REF
10036552	ConMet PreSet Plus® Spindle Nut TN	3.125"	Tapered	Trailer	CNM10036552
10036553	ConMet PreSet Plus® Spindle Nut TP	4"	Straight	Trailer	CNM10036553
10036548	ConMet PreSet Plus® Spindle Nut FF Course Flat	2"	Steer 13.5K GAWR	Meritor	CNM10036548
10036549	ConMet PreSet Plus® Spindle Nut FF Fine Key	2"	Steer 13.5K GAWR	Dana	CNM10036549
10036550	ConMet PreSet Plus® Spindle Nut FL	2.75"	Steer 16-20K GAWR	Vocational Steer	CNM10036550
10036551	ConMet PreSet Plus® Spindle Nut R	3.75"	All Drives	Drive Axle	CNM10036551



THE RIGHT BRAKE PARTS TO KEEP YOU ON YOUR JOURNEY



51,896

OUT-OF-SERVICE BRAKE VIOLATIONS²



BRAKE SYSTEMS

NO.1

FOR MOST OUT-OF-SERVICE VIOLATIONS

28%

%

OF LEVEL I, II, OR III INTERNATIONAL ROADCHECK INSPECTION OUT-OF-SERVICE VIOLATIONS¹

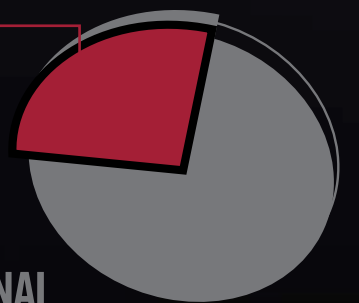

WHAT DOES MAINTENANCE INCLUDE?



Estimated ratio of related service items during brake maintenance:

100 : 19 : 14 : 7

BRAKE SHOES



CAMSHAFTS



CAM REPAIR KITS



SLACK ADJUSTERS



When it comes to you, there's no stopping us. Contact your Meritor representative or Customer Care at 888-725-9355 in U.S. or 800-387-3889 in Canada.

¹ During 2018 International Roadcheck, a total of 67,003 Level I, II, and III Inspections were conducted resulting in 16,003 out-of-service violations with 4,545 out-of-service violations attributed to brake systems.

² In all of 2021, Brakes out of service (396.3A1BOS) was the #2 out-of-service violation with 51,896 violations for all vehicles. (Data Source: FMCSA's Motor Carrier Management Information System (MCMIS) data snapshot as of 4/15/2022)



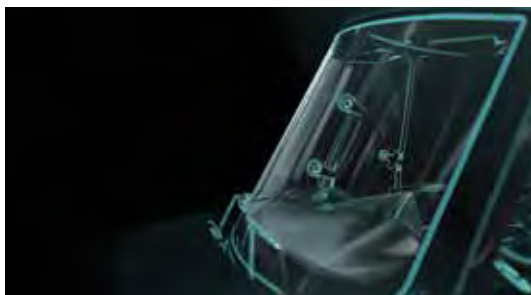

PREMIUM GLASS MAKES FOR QUALITY WINDSHIELDS.

We have everything you need to keep your truck looking great and your sight clear.

Order online at RepairLinkShop.com

PARTS FIT TO PERFORM

fleetrite.com



ABS FRONT AND REAR AXLE COVER KITS.

Super high-shine, durable and light weight. High impact and flexible. Resists dents and ships and DOES NOT RUST! Fits all 11.25 bolt circle wheels with 33mm or 1.5" nut covers. Kits include nut covers. Easy installation and removal. Guaranteed for one (1) full year against product defects, material and workmanship.

DELIVERING GLOBAL SOURCING AND DESIGN SOLUTIONS

americanchrome.com



MIRRORS



CONVEX MIRRORS							
PN	DESCRIPTION	APPLICATION	INTERNATIONAL X-REF	TRP X-REF	ALLIANCE X-REF	RE-TRAC X-REF	VELVAC X-REF
2505815C2	Glass Assembly, Black Head	3200, 4100, 4200, 4300, 4400, 7300, 7400, 7500, 7600, 7700, 8500, 8600, CACB, HVHD, HVMD, MIL, MV, PRO, TR01	—	—	—	—	—
2509979C1	Bezel, Black, Spot, R450	3200, 4100, 4200, 4300, 4400, 7300, 7400, 7500, 7600, 7700, 8500, 8600, CACB, HVHD, HVMD, MIL, MV, PRO, PROP, RH, TR01	—	—	—	—	—
3756624C92	Rear View, LH Standard	3200, 4100, 4200, 4300, 4400, 7300, 7400, 7500, 7600, 7700, 8500, 8600, CACB, PRO, TR01	—	—	—	—	—
2505813C2	Glass Assembly, Standard	3200, 4100, 4200, 4300, 4400, 7300, 7400, 7500, 7600, 7700, 8500, 8600, CACB, PRO, TR01	—	—	—	—	—
2516460C1	Heavy-Duty, Main	3200, 4100, 4200, 4300, 4400, 7300, 7400, 7500, 7600, 7700, 8500, 8600, CACB, TR01	—	—	—	—	—
3735636C92	Rear View, Premium	3200, 4100, 4200, 4300, 4400, 7300, 7400, 7500, 7600, 7700, 8500, 8600, CACB, RXT, TR01	—	—	—	—	—
2517368C1	Carrier Assembly with Glass, Main, Heated	CACB, HVHD, HVMD, HX, MV	—	—	—	—	—
2505294C1	Cover Back, Black, RH	3200, 4100, 4200, 4300, 4400, 7300, 7400, 7500, 7600, 7700, 8500, 8600, CACB, MXT, RXT, TR01	—	—	—	—	—
2592422C1	Control Assembly Actuator	3200, 4100, 4200, 4300, 4400, 7300, 7400, 7500, 7600, 7700, 8500, 8600, APRO, CACB, CXT, MXT, NC2, PRO, PROL, PROP, RXT, TG01, TR01	—	—	—	—	—
3756626C91	Rear View, Premium, LH	3200, 4200, 4300, 4400, 7300, 7400, 7500, 7600, 7700, 8500, 8600, CACB	—	—	—	—	—
3735634C92	Rear View, Premium	3200, 4200, 4300, 4400, 7300, 7400, 7500, 7600, 7700, 8500, 8600	—	—	—	—	—
FLTMIR4010	8.5" Offset, Stainless Steel	Universal Fit	—	SC1-8COF	ABP N74B 12801	982	708115
FLTMIR4005	7.5" Stainless Steel	Universal Fit	—	SC1-8C	ABP N74B 10701	873	708102
FLTMIR4001	5" Stainless Steel	Universal Fit	—	—	—	—	—
FLTMIR4012	8.5" Offset, Heated	Universal Fit	—	SH8SOFH	ABP N74B 12811	19SOSH, 980H	708457
FLTMIR4049	8-1/2" Stainless Steel	9200, 9400, 9800	—	SA8S	ABP N74B 10801	983	708441
FLTMIR4011	8-1/2" Heated, Stainless	2500, 2600, 4700, 4900, 8100	—	SH8S	ABP N74B 10811	983HJ5	708453
FLTMIR4055	4" x 8" Rectangular Over Door, Stainless Steel	—	—	SA48S	ABP N74B 10481	—	715198
FLTMIR4050	Mount Assembly, Tripod Fender with 8-1/2", Stainless Steel	—	—	SA50	ABP N74B 60111	60467	713444
FLTMIR4069	Tripod Assembly, Heavy-Duty Hood Mounted, 8-1/2", Stainless Steel	—	—	SA917S	ABP N74B 60171	3990, 3992	714620
FLTMIR4003	6", Stainless Steel	Universal Fit	—	—	—	953J5	708478
FLTMIR4009	8.5", Black	Universal Fit	—	—	—	—	—
FLTMIR4004	6", Black	Universal Fit	—	—	—	—	—
FLTMIR4085	6" X 8" Rectangular, Stainless Steel	2500	2013932C91, 2507272C1	—	—	—	—
FLTMIR4056	10.5" Round, Rear Cross View, Stainless Steel	Universal Fit	—	—	—	—	—

TRUCK/BUS MIRRORS S-SERIES			
PN	DESCRIPTION	APPLICATION	ALLIANCE X-REF
FLTMIR4072	Assembly Kit	Universal Fit	—
FLTMIR4078	West Coast Loop, Aluminum	Universal Fit	—
FLTMIR4074	System, International, 7" x 16" Flange Mounted, with International Plug, Aluminum, Driver Side	2500, 2600, 4700, 4800, 4900, 8100, 8500	ABP N74B 20080
FLTMIR4071	System, International, 7" x 16" Flange Mounted, with International Plug, Aluminum, Passenger Side	2500, 2600, 4700, 4800, 4900, 8100, 8500	ABP N74B 20090
FLTMIR4076	West Coast Bracket Kit	Universal Fit	ABP N78B 60699

WEST COAST MIRRORS						
FLEETRITE PN	DESCRIPTION	APPLICATION	TRP X-REF	ALLIANCE X-REF	RE-TRAC X-REF	VELVAC X-REF
FLTMIR4030	16", Rib, Black, Rectangular	—	—	ABP N74B 24403	1143	—
FLTMIR4024	16", Stainless Steel, Heated, Lighted	—	SH716SL	ABP N74B 20331	1159HL	708331
FLTMIR4038	7" x 16" OEM-Style, Heated, Stainless Steel	—	SM3202	ABP N74B 21101	1171H	708212
FLTMIR4018	6" x 16" Aluminum	Universal Fit	SA616A	ABP N74B 20100	1151	708078
FLTMIR4022	7" x 16" OEM, Heated, Stainless Steel	Universal Fit	SH716S	ABP N74B 20311	1159H	705335
FLTMIR4019	7" x 16" OEM, Stainless Steel	Universal Fit	SA716S	ABP N74B 20301	1159	705333
FLTMIR4070	7" x 16" Flange Mounted	Universal Fit	—	—	—	708335

MIRRORS (CONT'D)



FENDER, HOOD AND OVER DOOR MOUNT MIRRORS

PN	DESCRIPTION	APPLICATION
3787834C92	Hood, LH, Black	LT
3787835C92	Hood, RH, Black	LT
3787838C92	Hood, LH, Chrome	LT
3787839C92	Hood, RH, Chrome	LT

MIRROR HARDWARE



TRUCK/BUS

PN	DESCRIPTION	APPLICATION	FLEETRITE X-REF	DORMAN X-REF	AUTOMANN X-REF
2597071C91	Kit, Lower Holder, LH	3200, 4100, 4200, 4300, 4400, 7300, 7400, 7500, 7600, 7700, 8500, 8600, APRO, CACB, CXT, NC2, PRO, PROL, PROP, RXT, TG01, TR01	FLTMIR2597071	924-5105	563.55003
2509146C91	Kit, LH Receiver with Rivet	3200, 4100, 4200, 4300, 4400, 7300, 7400, 7500, 7600, 7700, 8500, 8600, APRO, CACB, NC2, PRO, PROL, PROP, RXT, TG01, TR01	—	—	—
2509147C91	Kit, RH Receiver with Rivet	3200, 4100, 4200, 4300, 4400, 7300, 7400, 7500, 7600, 7700, 8500, 8600, APRO, CACB, CXT, NC2, PRO, PROL, PROP, RXT, TG01, TR01	—	—	—
2505275C3	Bracket Assembly, RH, Black with Gasket	3200, 4100, 4200, 4300, 4400, 7300, 7400, 7500, 7600, 7700, 8500, 8600, CACB, PRO, TR01	—	—	—
2506238C91	Plate Assembly Structure Flat/Convex	3200, 4100, 4200, 4300, 4400, 7300, 7400, 7500, 7600, 7700, 8500, 8600, APRO, CACB, CXT, NC2, PRO, PROL, PROP, RXT, TG01, TR01	—	—	—
2505274C3	Bracket Assembly, LH, Black with Gasket	3200, 4100, 4200, 4300, 4400, 7300, 7400, 7500, 7600, 7700, 8500, 8600, CACB, TR01	—	—	—
2505326C3	Bracket, RH, with Gasket	3200, 4100, 4200, 4300, 4400, 7300, 7400, 7500, 7600, 7700, 8500, 8600, CACB, PRO, PROL, PROP, RXT, TG01, TR01	—	—	—

MIRROR PARTS

PN	DESCRIPTION	APPLICATION	FLEETRITE X-REF	DORMAN X-REF	AUTOMANN X-REF
2595653C1	Control Assembly, Actuator TS	660, 8600, PRO, PROL, PROP, TG01	—	—	—
2589155C92	Kit, Main, Heavy-Duty Trim Ring and Glass	CF50, CF60, JCF5, JCF6	—	—	—
2596378C1	Gasket, Mounting Bracket, Upper LH	CF50, CF60, JCF5, JCF6	—	—	—
2589156C91	Kit, Convex, Heavy-Duty Trim Ring and Glass	CF50, CF60, JCF5, JCF6	—	—	—
2512748C1	Head, Convex	J650, J750	—	—	—
2515514C91	Bracket Assembly, RH, Black, RMT, HT	HX	—	—	—
2597075C91	Bracket, RH, Lower	3200, 4100, 4200, 4300, 4400, 7300, 7400, 7500, 7600, 7700, 8500, 8600, APRO, CACB, CXT, NC2, PRO, PROL, PROP, RXT, TG01, TR01	FLTMIR2597075	924-5106	563.55004



FLEETRITE

PN	DESCRIPTION	APPLICATION	INTERNATIONAL X-REF
FLTMIR2597075	Mirror Arm Cover	Universal Fit	2597075C91
FLTMIR4037	Inline Bracket for Convex Mirror	Universal Fit	1608857C1, 1618585C1, 477868C1
FLTMIR2509069	Upper Mirror Holder	Universal Fit	2509069C91
FLTMIR2597071	Mirror Arm Cover	Universal Fit	2597071C91
FLTMIR4105	Clamp, 3/4" Tube, 1/4" Holes	Universal Fit	—
FLTMIR2509068	Upper Mirror Holder	Universal Fit	2509068C91
FLTMIR2507274	Head Clamp and Screw Kit	Universal Fit	2507274C1



INTERNATIONAL AERODYNAMIC MIRRORS

PN	DESCRIPTION	APPLICATION	AUTOMANN X-REF
3602837C96	Rear View, RH	4100, 4200, 4300, 4400, 7300, 7400, 7500, 7600, 7700, 8500, 8600, PRO, TR01	563.55002
3594841C3	Assembly, Hood	PRO, PROP, RH	563.55007
3594842C3	Hood Mounted, Rear View, Black, RH	PRO, PROP, RH	563.55008
3594843C3	Fender Mounted, Stainless Steel, Rear View, LH	PRO, PROL, PROP, RH	563.55007C
3594844C3	Fender Mounted, Stainless Steel, Rear View, RH	PRO, PROL, PROP, RH	563.55008C

WIPER BLADES, ARMS AND MOTORS



WIPER BLADES						
PN	DESCRIPTION	ANCO X-REF	TRP X-REF	ALLIANCE X-REF	AUTOMANN X-REF	TRICO X-REF
CONVENTIONAL WIPER BLADES						
FLTS16	16" M5 Conventional Metal Wiper Blade, Series 52	31-16, ANCO3116B100	WP16031	ABP N82 7516	HLK8116	82-161
FLTS18	18" M5 Conventional Metal Wiper Blade, Series 52	31-18, ANCO3118B10, ANCO3118B100	WP18031	ABP N82 7518	HLK8118	82-181
FLTS20	20" M5 Conventional Metal Wiper Blade, Series 52	31-20, ANCO3120B10, ANCO3120B100	WP20031	ABP N82 7520	HLK8120	82-201
FLTS22	22" M5 Conventional Metal Wiper Blade, Series 52	31-22, ANCO3122B10, ANCO3122B100	WP22031	ABP N82 7522	HLK8122	82-221
FLTS24	24" M5 Conventional Metal Wiper Blade, Series 52	31-24, ANCO3124B10	WP24031	ABP N82 7524	HLK8124	82-241
PREMIUM WIPER BLADES						
FLTP16	16" M6 Pro Conventional, Metal Wiper Blade	91-16, ANCO9116B5	—	ABP N82 7616	—	16-1
FLTP18	18" M6 Pro Conventional, Metal Wiper Blade	91-18, ANCO9118B10, ANCO9118B100	WC18-50B	ABP N82 7618	—	18-1
FLTP20	20" M6 Pro Conventional, Metal Wiper Blade	91-20, ANCO9120B10	WC20-50B	ABP N82 7620	—	20-1
FLTP22	22" M6 Pro Conventional, Metal Wiper Blade	91-22, ANCO9122B10, ANCO9122B100	WC20-50B	ABP N82 7622	—	22-1
FLTP24	24" M6 Conventional, Metal Wiper Blade	91-24, ANCO9124B10	—	ABP N82 7624	—	24-1
WINTER WIPER BLADES						
FLTW16	16" W1 Winter Wiper Blade	30-16, ANCO3016B10	WW16012	ABP N82 W16	—	37-160
FLTW18	18" W1 Winter Wiper Blade	30-18, 3651898, ANCO3018B10, ANCO3018B100	WW18012	ABP N82 W18	—	37-180
FLTW20	20" W1 Winter Wiper Blade	30-20, 3672098FDM, ANCO3020B10, ANCO3020B100	WW20012	ABP N82 W20	—	37-205
FLTW22	22" W1 Winter Wiper Blade	30-22, 3672298, ANCO3022B10, ANCO3022B100	WW22012	ABP N82 W22	—	37-225
FLTW24	24" W1 Winter Wiper Blade	30-24, 3672498, ANCO3024, ANCO3024B10	WW24011	ABP N82 W24	—	37-245
UNIVERSAL FLEX WIPER BLADES						
FLTB18	18" F8 Universal Flex Wiper Blade	C18UB, WX18UB, WX18OE, ANCO18UB, ANCOWX18UB, ANCOWX18OE	—	—	—	16-180
FLTB20	20" F8 Universal Flex Wiper Blade	C20UB, WX20UB, WX20OE, ANCO20UB, ANCOWX20UB, ANCOWX20OE	—	—	—	16-200
FLTB22	22" F8 Universal Flex Wiper Blade	C22UB, WX22UB, WX22OE, ANCO22UB, ANCOWX22UB, ANCOWX22OE	—	—	—	16-220
FLTB24	24" F8 Universal Flex Wiper Blade	WX24UB, WX24OE, ANCOWX24UB, ANCOWX24OE	—	—	—	16-240
HEAVY-DUTY SADDLE WIPER BLADES						
FLTSM28	28" 78 Series Heavy-Duty Saddle Wiper Blade	50-28, ANCO5028, ANCOC28UB	—	ABP N82 7728	—	68-281

*Other Sizes and Styles Available.



Fleetrite® Grilles - Great Option for OEM Fit

Fleetrite has grilles for heavy-duty trucks including International, Freightliner, Kenworth and Peterbilt, Volvo and Hino. Fleetrite grilles are easily installed and precision engineered to be a great replacement option for OEM fit.

fleetrite.com



WIPER BLADES, ARMS AND MOTORS (CONT'D)



WIPER ARMS AND WIPER SWITCHES

APPLICATION	OE PN	DESCRIPTION	DORMAN X-REF	AUTOMANN X-REF	S&S TRUCK X-REF
Freightliner Cascadia Model 2009 – 2012	A22-66578-001	Wiper Arm	—	HLK7012	S-22410
Freightliner Century, Columbia Series	A22-51969-000	Wiper Arm	—	HLK7006	S-19665
Freightliner Century, Columbia Series	A2247433002	Wiper Arm	—	HLK7004	—
Freightliner FLD120 1999 – 2010, FLD120 SD 2003 – 2009	4188-30-BWS	Wiper Arm	—	HLK7005	S-19443
International 5000, 5000i, 5600i, 5900i, 9100, 9200, 9400, 9800, 9900	3527221C1	Wiper Arm, Driver Side	—	HLK7000	S-21201
Kenworth	R23-1029-23	Wiper Arm Kit, RH	—	HLK7014	—
Kenworth T-Series	GS-3383	Wiper Arm, LH	—	HLK7002	—
Kenworth T-Series	GS-3382	Wiper Arm, RH	—	HLK7001	—
Kenworth T600 2008 – 2012, T600A 2006 – 2007, T660 and T800 2006 – 2012	R23-1023-12	Steel Wiper Arm, J-Hook Style, Black, LH	602-5403	HLK7009	—
Kenworth T600 2008 – 2012, T600A 2006 – 2007, T660 and T800 2006 – 2012	R23-1029-13	Steel Wiper Arm, J-Hook Style, Black, RH	602-5404	HLK7008	—
Kenworth T600, T600A, T800, W900 1985 – 2015	R23-1029-22	Plastic/Steel Wiper Arm, 27-1/2", Spine/Lock, Black	602-5405	HLK7013	—
Mack CHN, CV, CX, CXV, CXU, CXN	1MR4336, 25173793	Wiper Switch	—	577.62511	—
Mack MR 1981-2007, Mack MRU 2008 – 2017	82715999	Steel Wiper Arm, 29", Gloss Finish, Black	602-5412	HLK7050	—
Peterbilt	GS4911	Wiper Arm	—	HLK7010	—
Peterbilt 220, 378, 379, 387	75600-26	Wiper Switch, 6 Leads Packaged	—	—	—
Peterbilt 379 Series 1990 – 2007	R23-6002	Steel Wiper Arm, 14", Black	602-5411	HLK7003	S-19903
Peterbilt 379, Kenworth T2000	1501-002	Wiper Arm	—	HLK7011	—
Volvo 850 1994 – 1997	9151088-3	Steel Wiper Arm, 33.11" Spine/Flange Nut Attachment, Front Right, Black	42951	—	—
Volvo 850 1994 – 1997	91510878	Steel Wiper Arm, 33.11" Spine/Flange Nut Attachment, Front Left, Black	42950	—	—
Volvo Early VN Series	3980443	Wiper Arm, LH, RH	—	HLK7007	S-21052



WIPER MOTORS

MAKE	YEAR	MODEL/APPLICATION	SPRAGUE X-REF	BRACKET OR CABLE X-REF	AUTOMANN X-REF	TRICO X-REF
Freightliner	2000 – Current	Cascadia, Century, Columbia, Coronado	E008-221	—	577.46923	—
Freightliner	2001 – Current	M2	E008-221	E007-101	577.46923	—
Freightliner	All	FLD	E008-223	—	577.46921	—
International	Mid-2007 – Current	9200, 9400, 9900, 5500, 5900 PayStar® 5000, 3-Bolt	E008-224	—	577.59954	—
International	2005 – 2007	9200, 9400, 9900, 5500, 5900 PayStar® 5000, 4-Bolt	E008-224	GS-4920	577.59954	—
International	Prior to 2005	9200, 9400, 9900, 5500, 5900 Requires Connector Gender Kit	E008-224	E-007-099	577.59954	—
International	1999 – Current	4000, 8000, 7000 Series (TerraStar®, DuraStar®, WorkStar®)	E008-221	—	577.46923	—
International	2007 – Current	ProStar®, LoneStar®, TranStar®	E008-221	—	577.46923	—
International	2005	4400	2594086C91	—	577.55999	98999-247
International	1997, 1998 – Current	School Buses Chassis, Heavy Service Trucks, 2500, 2600, 8100 1998 - Current; MD Built, 3000, 4700, 4800, 4900 1997 - Current; Heavy Tractors Built, 8100	3539699C91	—	577.55991	91697-26
Kenworth	1987 – 2006 (Mid-Years)	C500, T300, T400, T450, T600, T800, W900, 3-Bolt	E008-223	—	577.46921	—
Kenworth	2006 – 2009/2010	C500, T300, T400, T450, T600, T800, W900, 4-Bolt	E006-226	—	577.75992	—
Kenworth	2010 – Current	C500, T300, T400, T450, T600, T800, W900, 3-Bolt	E008-224	—	577.59954	—
Kenworth	All	T2000, T700	E008-224	E007-101	577.59954	—
Mack	1988 – Current	C and CH Series Fusion, Vision, Granite, Pinnacle, Titan	E008-230	—	577.62312	—
Mack	1994 – Current	LE, Low Entry Waste/Refuse	E008-223	—	577.46921	—
Mack	All	RD, Requires Bracket Modification	E008-223	—	577.46921	—
Peterbilt	1985 – Current	379, 330, 389, 337, 348, 340, 335, 386, 385	E008-222	—	577.59954	—
Peterbilt	2000	379	E006-185	—	577.75990	—
Peterbilt	2005	377, 379	E008-109	—	577.75991	—
Peterbilt	All	387, 587	E008-224	E007-101	577.59954	—

WINDSHIELDS



FLEETRITE			
PN	DESCRIPTION	APPLICATION	INTERNATIONAL X-REF
FLTDW01732PK4	Pack of 4 Pieces, Freightliner	Freightliner	—
FLTDW01731PK4	Pack of 4 Pieces, Passenger S	—	—
FLTDW01731PK1	Freightliner Cascadia, Passenger S	Freightliner Cascadia	—
FLTDW01732PK1	Freightliner Cascadia, Driver S	Freightliner Cascadia	—
FLTDW01000PK1	1 Piece, Freightliner Cascadia	Freightliner Cascadia	—
FLTDW01685PK4	2 Piece, Encapsulated Asymmetrical	International	3554252C6
FLTDW01451PK4	Pack of 4 Pieces, Encapsulated	International	3554252C4
FLTDW01710PK4	Pack of 4 Pieces, Encapsulated Asymmetrical	International	3714740C1
FLTDW01645PK1	1 Piece, Tinted	ICE Bus	2202541C3
FLTDW016450PK1	1 Piece, Shaded	ICE Bus	2202541C3



WINDSHIELDS				
PN	DESCRIPTION	APPLICATION	TRP X-REF	NAGS X-REF
3554252C6	Assembly, Solex Tint, Unprimed	3200, 4100, 4200, 4300, 4400, 7300, 7400, 7500, 7600, 7700, 8500, 8600, APRO, CACB, CASB, CXT, HVHD, HVMD, LT, MIL1, MV, MXT, NC2, PRO, PROL, PROP, RH, RXT, TR01	—	—
2593024C1	Assembly, Solex Tint, Unprimed	—	—	—
2509373C1	Flat, LAM Solex, 1 Piece	—	—	—
1666092C3	Assembly, Solex, Tinted	2500, 2600, 3000, 4700, 4800, 4900, 8100, 8500	DL4761-5	DL4761
1670093C3	Assembly, RH, Solex	9800	DW1128-5	DW1128
2202541C3	Flat, Clear, UV-Treated, 84.9" x 28.5" x 28.5" x 80.7"	BE20, EVSB, IC Bus	GB482059-5, GB482059-25	—
2592446C1	RH, Solex, Unprimed	5000, 5500, 5600, 9100, 9200, 9400, 9900	DW1664-5, DW1664-20	DW1664
2592447C1	LH, Solex, Unprimed	5000, 5500, 5600, 9100, 9200, 9400, 9900	DW1665-5, DW1665-20	DW1665
2592448C1	Solex, Unprimed, 1 Piece	5000, 5500, 5600, 5900, 9100, 9200, 9400, 9900	DW1663-5, DW1663-20	DW1663
3554252C4	Encapsulated, Clear UV Treated, 1 Piece	3200, 4100, 4200, 4300, 4400, 7300, 7400, 7500, 7600, 7700, 8500, 8600, APRO, CACB, CASB, CXT, HVHD, HVMD, LT, MIL1, MV, MXT, NC2, PRO, PROL, PROP, RH, RXT, TR01	DW1765-5, DW1765-20	DW1765

TRIM



TRIM		
PN	DESCRIPTION	APPLICATION
3576482C2	Bezel, Door Handle, LH, Outer	3200, 4100, 4200, 4300, 4400, 7300, 7400, 7500, 7600, 7700, 8500, 8600, APRO, CACB, CASB, CXT, MIL1, MXT, NC2, PRO, PROP, RXT, TG01, TR01
3576483C2	Bezel, Door Handle, RH, Outer	3200, 4100, 4200, 4300, 4400, 7300, 7400, 7500, 7600, 7700, 8500, 8600, APRO, CACB, CXT, MIL1, MXT, NC2, PRO, PROP, RXT, TG01, TR01
2511096C1	Trim, Aisle, Bus, Aluminum, 91"	30FE, 30IC, 30RE, BE20, CASB, EVSB, FECB, FESB, IC Bus, RECB, RESB
449765C1	Weatherstrip, Door, Cab Dr 135"	1652, 2500, 2600, 3000, 3047, 30FE, 30IC, 30RE, 3200, 3300, 3600, 3800, 4100, 4200, 4300, 4400, 4700, 4800, 4900, 5000, 5500, 5600, 5900, 660, 680, 7300, 7400, 7500, 7600, 7700, 8100, 8500, 8600, 9200, 9300, 9400, 9800, 9900, APRO, BE20, CACB, CASB, CF50, CF60, CV, CXT, EVMV, EVSB, FBCB, FBTC, FECB, FESB, GM, HVHD, HVMD, HX, IC Bus, J650, J750, JCF5, JCF6, LS, LT, MIL, MIL1, MIL2, MV, MXT, NC2, PRO, PROL, PROP, RECB, RESB, RH, RXT, SFCB, TG01, TR01
2514719C3	Shell, Right Hand Chrome, TXT	EVMV, HVHD, HVMD, HX, LS, LT, MV, RH
3576482C2	Bezel, Door Handle, LH, Outer	3200, 4100, 4200, 4300, 4400, 7300, 7400, 7500, 7600, 7700, 8500, 8600, APRO, CACB, CASB, CXT, MIL1, MXT, NC2, PRO, PROP, RXT, TG01, TR01
3765257C94	Bezel, Trim, Assembly, Instrument Panel Wing	HVHD, HVMD, HX, LS, LT, MV, RH



Fleetrite® Bumper Options

Fleetrite provides quality parts with many bumper options to fit your heavy-duty truck. Fleetrite bumpers are available in chrome or painted finishes and are designed to be lightweight and aerodynamic.

fleetrite.com



**WE DIDN'T BRING THE WORLD'S
GREATEST MINDS TOGETHER
TO MAKE A SMALL CHANGE.**



*Comparing the fuel economy of the 2017 GHG International® A26 engine in a 2017 International® LT® Series truck with aero package to the fuel economy of the new International® S13 Integrated Powertrain in a 2024 International® LT® Series truck with the LT aero package and chassis enablers. Actual customer results may vary due to various factors, including but not limited to truck specifications, weight of the vehicle, predictive features, environmental conditions, etc. ©2023 Navistar, Inc. All rights reserved. All marks are trademarks of their respective owners.

We brought them together to change everything.

Introducing the revolutionary International® S13 Integrated Powertrain. Brought to you by a global collaboration of industry powerhouses, it's meticulously engineered to set a new standard for the industry. With a dual-stage aftertreatment system, superior emission control, and an up to 15% boost in fuel economy*, it makes a cleaner impact on the environment and bridges the gap between where we are now and where we're going in the future. You needed a big change. You got it.

SHIFT WHAT'S POSSIBLE
INTERNATIONALTRUCKS.COM/S13



HOODS



INTERNATIONAL		
PN	DESCRIPTION	APPLICATION
3822156C98	Hood, Assembly, Low Cab No Hatch	4200, 4300, 7300, CACB, MV
4088267C91	Hood, Assembly, As Purchased, Medium-Duty	4300, 4400, 7300, 7400, MV
4036099C99	Hood, As Purchased, 125 Bumper to Back of Cab	LT
3613760C94	Hood, Assembly, No Access Hatch	7300, 7400, 7500, CXT, HVMD, MIL1
4059025C93	Hood, Assembly, SBA, 115 Bumper to Back of Cab	HX
4059026C93	Hood, Assembly, SBA, 119 Bumper to Back of Cab	HX
3551828C98	Hood	5500
3551824C96	Hood Assembly, As Purchased	9100, 9200
3551825C95	Hood Assembly, As Purchased	9400
4078054C99	Hood Assembly	CV, GM

FLEETRITE			
PN	DESCRIPTION	APPLICATION	INTERNATIONAL X-REF
FLTH9900S	Short Hood with Breathers, 57" Length	9900	3531924C91, 3552478C93, 3552478C94, 3867439C94, 3867440C94, 3867440C95
FLTH9900SNB	Short Hood, 57" Length	9900	3524263C91, 3531917C91, 3867439C94, 3867439C95
FLTHPROSTAR	Hood, Assembly, 122" Length	ProStar®	3858844C92
FLTHKENT600	Aerodynamic 3-Piece Hood	Kenworth T-600	—
FLTHKENW900LCP	Curved Windshield Hood, 66" Length	Kenworth W-900L	—
FLTHKENT800FP	Curved Windshield Hood with Plastic External Air Breathers, 5-Bolt Holes for Hinge, 60.5" Length	Kenworth T-800	—
FLTHFLM2106B	Hood with Bezel	Freightliner M2	—
FLTHCASL	Long Hood, Hinge Bar Included, 50" Length	Freightliner Cascadia	—



HOOD HARDWARE



INTERNATIONAL							
PN	DESCRIPTION	APPLICATION	DORMAN X-REF	AUTOMANN X-REF	ATRO X-REF	TRP X-REF	S&S X-REF
1699929C91	Hood Latch, Kit	1400, 1600, 1652, 1700, 1800, 1900, 2100, 2200, 2300, 2500, 2600, 3400, 3600, 3700, 3800, 3900, 4500, 4600, 4700, 4800, 4900, 7100, 8100, 8200, 8300, 9300, 9400	315-5101, 315-5101CD	HLN1002	HL55-64C91	HL0048	—
1699930C93	Hood Latch, Kit	2500, 2600, 5000, 8100, 8200, 8300, 9200, 9300, 9400	—	HLK2011	HL55-64C91	—	—
4063022C2	Hood Spring, Assist Strut	HX	—	—	—	—	—
4063023C2	Hood Spring, Assist Strut LOC	HX	—	—	—	—	—
1668950C1	Hood Insulator MTG	5000, 5500, 5600, 5900, 5500I, 5600I, 5900I, 7300, 7400, 7500, 7600, 7700, 8100, 8500, 8600, 9100, 9200, 9300, 9400, 9900, HX	—	—	—	—	—
3559239C3	Hood Guide, Rear Support	5500, 5600, 5900, 680, 9100, 9200, 9400, 9900, HX	—	—	—	—	—
3588532C2	Hood Cable Spring	9200, 9400, 9200I, 9400I	938-5102	104.3532	—	HS3532	S-21122
3558776C2	Hood Latch	8600	—	HLK1021	—	—	—
3811831C1	Hood Latch Assembly	5900, 8600, CACB, CASB, CV, GM, HX, LS, NC2, TG01, TR01	—	HLK2608	—	—	—
3577833C1	Hood Latch, Handle, Catch	2500, 2600, 5000, 5500, 5600, 5900, 680, 8100, 9100, 9200, 9300, 9400, 9900, HX	—	HLK2010	—	—	—
3544924C1	Hood Latch Strap, RH	3200, 4100, 4200, 4300, 4400, 7300, 7400, 7500, 7600, 7700, 8500, APRO, CACB, CXT, EVMV, HVHD, HVMD, LT, MIL, MIL1, MV, NC2, PRO, PROL, PROP, RH, RXT	—	HLK1022	—	—	—
556946C1	Hood Retainer	2500, 2600, 5000, 5500, 5600, 5900, 680, 8100, 9100, 9200, 9300, 9400, 9900, HX	—	HLK2008	—	—	—
3558777C1	Hood Latch Catch, Safety	5900, 660, 680, 8600, CACB, CASB, CV, GM, HX, LS, NC2, TG01, TR01	—	HLK1099	—	—	—
500270C1	Hood Latch Retainer, International Multi-Series 1980 - 2011	2500, 2600, 3000, 3047, 30IC, 3300, 3800, 4700, 4800, 4900, 8100, 8500, BE20, EVSB, FBCB, FBTC, ICCB, ICSB	—	—	—	—	—
500273C2	Hood Latch Pin, International Multi-Series 1980 - 2011	2500, 2600, 3000, 3047, 30IC, 3300, 3600, 3800, 4700, 4800, 4900, 8100, 8500, BE20, EVSB, FBCB, FBTC, ICCB, ICSB	—	—	—	—	—
500269C1	Hood Latch Handle, International Multi-Series 1980 - 2011	2500, 2600, 3000, 3047, 30IC, 3300, 3600, 3800, 4700, 4800, 4900, 8100, 8500, BE20, EVSB, FBCB, FBTC, ICCB, ICSB	—	—	—	—	—

HOOD HARDWARE (CONT'D)



INTERNATIONAL (CONT'D)								
PN	DESCRIPTION	APPLICATION	DORMAN X-REF	AUTOMANN X-REF	ATRO X-REF	TRP X-REF	S&S X-REF	
499523C3	Hood Latch Strap, International Multi-Series 1980 – 2011	2500, 2600, 3000, 3047, 301C, 3300, 3800, 4700, 4800, 4900, 8100, 8500, BE20, EVSB, FBCB, FBTC, ICCB, ICSB	—	—	—	—	—	—
500271C1	Hood Lower Latch Catch, Latch, International Multi-Series 1980 – 2011	2500, 2600, 3000, 3047, 301C, 3300, 3600, 3800, 4700, 4800, 4900, 5000, 5500, 5600, 5900, 680, 8100, 8500, 9100, 9200, 9300, 9400, 9900, BE20, EVSB, FBCB, FBTC, HX, ICCB, ICSB	—	—	HLN1002E	—	—	—
3577047C2	Hood Pivot Bracket	3300, BE20, EVSB, FBCB, FBTC, ICCB, ICSB	—	M55472	—	—	—	—
1677457C1	Hood Assist Cable, 24-1/4" Length, International Multiple Models	2500, 3000, 3047, 3800, 4700, 4800, 4900, 9900	—	HLK2177	—	—	—	—
3551734C2	Hood Cable, 21" Length	3200, 3300, 4100, 4200, 4300, 4400, 7300, 7400, 7500, 8500, BE20, CACB, EVSB, FBCB, FBTC, HVMD, IC Bus, MIL, MV, MXT, RXT	—	HLK2174	—	—	—	S-20631
1675762C3	Hood Tilt Assist Spring, without Snow Valve, Zinc Plated	2500, 3000, 3047, 3800, 4700, 4800, 4900	938-5101	104.3531	—	HS3531	—	S-21242
598574C3	Hood Tilt Assist Spring, Zinc Plated	2500, 2600, 5000, 9100, 9200, 9400	938-5103	104.3533	—	HS3533	—	—

BUMPERS



ALL-MAKES						
PN	DESCRIPTION	APPLICATION	TRP X-REF	HENDRICKSON X-REF	ALLIANCE X-REF	FREIGHTLINER/MACK/ X-REF
AM7100	16" Rolled End Taper, Bolt Holes, Tow Hook Holes, Tire Guards	Universal Fit	TU71B0014-02	7100	ABP N31 7BA001002	—
AM7209NLSQ	18" Texas Square, Bolt Holes, Tow Pin Holes, Tire Guards	Universal Fit	TX72F0020-06TS	7209NLSQ	ABP N31 7CB001006	5887-7209NLSQ
AM0291SSC	14" Set-back Axle, Bolt Holes, Hitch Holes, Vent Holes, Includes Step	Universal Fit	TU22Q0210-32	0291SSC	ABP N31 0CN001115	—
AM0292SSC	14" Set-back Axle, Bolt Holes, Hitch Holes, Vent Holes, Includes Step	Universal Fit	TU22P0210-32	0292SSC	—	5887-0292SSC
AM0256NLSSC	14" Set-back Axle, 3-Piece, Bolt Holes, Tow Holes, Vent Holes, Extensions Included	Universal Fit	TU22C0017-32TF	0256NLSSC	ABP N31 0CY001115X	A21-28546-018, A21-28546-054
AM0256SSC	14" Set-back Axle, 3-Piece, Bolt Holes, Factory Mount Light Holes, Tow Holes, Vent Holes, Extensions	Universal Fit	TX02YD011-25TF	0256SSC	ABP N31 0CY01115X	A21-28546-006, A21-28546-052
AM0420SSC	14" Set-back Axle, Bolt Holes, Tow Pin Holes, Vent Holes	Universal Fit	TU24P0017-29	0420SSC	ABP N31 0EP001115	58870420SSC
AM0450SSC	16" Set-back Axle, Bolt Holes, Light Holes, Tow Holes, Vent Holes, Fixed Mount, Extensions Included	Caterpillar	TX0452011-18TF	0450SSC	ABP N31 0EU501116X	—
AM7442SSC	14" Factory Style End, Bolt Holes, Light Holes, Vent Holes	Universal Fit	—	7442SSC	ABP N31 0EV500138	—
AM7512SQ	18" Texas Square, Bolt Holes, Tow Pin Holes, Tire Guards	Universal Fit	TU7510010-06TS	7512SQ	ABP N31 7FE001006	—
AM7522SQ18	18" Box End Square, Bolt Holes, Tow Pin Holes, Tire Guards	Universal Fit	TU7510010-11TS	7522SQ18	ABP N31 7FE001011	—
AM0521SQ	20" Box End Square, Bolt Holes, Tow Pin Holes, Tire Guards	Universal Fit	TU0510010-51TS	0521SQ	ABP N31 0FE001051	—
AM7502SQ	18" Texas Square, Bolt Holes, Step Holes, Tow Pin Holes, Tire Guards	Universal Fit	TU7510210-06TS	7502SQ	ABP N31 7FE021006	—
AM7530	14" Square with 7" Break Back, Bolt Holes, Center High Step, Tow Pin Holes	Universal Fit	TU75G0011-25NS	7530	ABP N31 7FG010125	—
AM7540	14" Tapered with 7" Break Back, Bolt Holes, Center High Step, Tow Pin Holes	Universal Fit	TU75G0011-26NS	7540	ABP N31 7FG010126	5887-7540
AM05R1NLSSC	13" Set-back Axle, Bolt Holes, Tow Holes, Vent Holes, Brackets Included	Universal Fit	TU25R0019-22NS	05R1NLSSC	ABP N31 0FR001115	—
AM0804	16" Rolled End Taper, Bolt Holes, Tow Pin Holes, Tire Guards	Universal Fit	TU08C0020-02TS	0804	ABP N31 0HC001002	3948792
AM0804SQ	18" Texas Square, Bolt Holes, Tow Pin Holes, Tire Guards	Universal Fit	TU08C0020-06TS	0804SQ	ABP N31 0HC001006	5887-0804SQ
AM7807SQ	18" Box End Square, Bolt Holes, Tow Pin Holes, Tire Guards	Universal Fit	TU78C0020-11TS	7807SQ	ABP N31 7HC001011	5887-7807SQ
AM0809SQ20	20" Box End Square, Bolt Holes, Tow Pin Holes, Tire Guards	Universal Fit	TU08C0020-51TS	0809SQ20	ABP N31 0HC001051	—
AM08V1	16" Tapered, Bolt Holes, Tow Pin Holes, Tire Guards	Universal Fit	—	08V1	—	—
AM78V1SQ	18" Texas Square, Bolt Holes, Tow Pin Holes, Tire Guards	Universal Fit	TU78V0010-06TS	78V1SQ	—	—
AM08V1SQ	18" Texas Square, Bolt Holes, Tow Pin Holes, Tire Guards	Universal Fit	TU08V0010-06TS	08V1SQ	—	—
AM0961NLSSC	14" Set-back Axle, Bolt Holes, Tow Holes, Vent Holes	Universal Fit	—	MM0961NLSSC	ABP N31 0LH001115	20470446 (Center)

BUMPERS (CONT'D)



INTERNATIONAL		
PN	DESCRIPTION	APPLICATION
2512178C91	Assembly, Non-Tilting	PRO
3720618C3	Center Fascia, Bumper Cut Out, Right	PRO, PROL, PROP, RH
2512179C91	Assembly, Non-Tilting	PRO
3720617C3	Front, Center Fascia, Bumper Cut Out, Left	PRO, PROL, PROP, RH
3704775C2	Front, 15 Degree Swept	7300, 7400, 7500, 7600, HVHD, HVMD
3720611C4	Front, Center Fascia, Bumper Cut Out	PRO, RH
3998549C93	Front Assembly, Wingman	PRO, RH
2607185C92	Front Assembly, Grey Bumper Cut Out, Standard	PRO
6088129C94	Assembly, Standard Painted Grey	PRO, PROP
3720648C2	Front, Bright Over	PRO, PROL, PROP, RH
3542417C3	Front, Painted Swept	7300, 7400, 7500, 7600, 7700
3720622C3	Front, Center Fascia, Bumper Cut Out	PRO, PROL, PROP, RH
2512180C91	Assembly Non-Tilting	PRO
3720614C5	Front, Center Fascia, Bumper Cut Out	PRO, PROL, PROP, RH
4073857C91	Front, Assembly, Bumper Cut Out, Standard	PRO, RH
2512181C91	Assembly Non-Tilting	PRO
3720647C2	Front, Bright Over	PRO, PROL, PROP, RH
4079730C1	Front, Aerodynamic SBA	7300, 7400, 7500, 7600, 7700, HVHD, HVMD
3704779C1	30 Degree Swept	7300, 7400, 7500, 7600, HVHD, HVMD
3704770C2	Front, Stainless Steel, SBA Painted	7300, 7400, 7500, 7600, HVHD, HVMD
3542418C3	Front, Painted Swept	7300, 7400, 7500, 7600
3592020C92	Front Assembly	CF50, CF60, JCF5, JCF6

FLEETRITE			
PN	DESCRIPTION	APPLICATION	INTERNATIONAL X-REF
FLTBDURP	Front, Aerodynamic	International DuraStar®	3610939C2, 3610939C3
FLTBDURC	Cab, Chrome, Steel, Large Tow Hook Hole	International DuraStar®	3610935C2, 3610935C3
FLTBCASC	Cab, Clad with Kit	Freightliner Cascadia	AM0257NLSSC
FLTBCASPGNOFL	Assembly without Holes 2008 - Current	Freightliner Cascadia	—
FLTBT800A	Center, Aluminum	Kenworth T-800	—
FLTBT800CP	Center, Metal, Grey	Kenworth T-800	—
FLTBT800LP	Left Side Extension	Kenworth T-800	—
FLTBT800RP	Right Side, Fiberglass, White	Kenworth T-800	—
FLTBT660M	Cab, Mesh	Kenworth T-660	—
FLTBCOLB	Cab, Chrome	Freightliner Columbia	—
FLTBVNL3P	Cab, 3rd Generation, Fiberglass	Volvo VNL	—
FLTBDURPG	Front, Aerodynamic, 2.67mm, Q	International DuraStar®	—



BUMPER HARDWARE



INTERNATIONAL

PN	DESCRIPTION	APPLICATION
6091025C2	Brace, Front Bumper, RH	LT, NC2, PRO, PROL, PROP
6091023C2	Brace, Front Bumper, RH Upper	LT, NC2, PRO, PROL, PROP
6091024C2	Brace, Front Bumper, LH Upper	LT, NC2, PRO, PROL, PROP
3674781C1	Latch, Front Bumper, Rubber	PRO, PROL, PROP
3622803C1	Brace, Front Bumper, RH, Support Tube	PRO, PROL, PROP
3622802C1	Brace, Front Bumper, LH, Support Tube	PRO, PROL, PROP
3627363C3	Bracket, Bumper, RH	PRO, PROL, PROP
6087233C4	Filler Top Bumper, Mounting RH	NC2, PRO, PROL, PROP, RH
3720644C1	Tape, Bumper Seal, Two Sided, 1"	PRO, PROL, PROP, RH
3627362C3	Bracket, Bumper, LH	PRO, PROL, PROP
3720623C93	Brace, Front Bumper, Hinge Assembly	PRO
3622771C91	Brace, Front Bumper, Front Hinge Assembly	PRO, PROL, PROP

GRILLE ASSEMBLY



ALL-MAKES

PN	DESCRIPTION	APPLICATION
3571803C96	Grille Assembly, Chrome	J650, J750
3614791C92	Grille Assembly, Chrome, International	CF50, CF60
3571802C95	Grille Assembly, Standard Painted	J650, J750
3586430C92	Grille Assembly, Filler Panel, RH	CF50, CF60, JCF5, JCF6

INTERNATIONAL

PN	DESCRIPTION	APPLICATION	FLEETRITE X-REF	DORMAN X-REF
4039860C94	Grille Assembly, Chrome	LT	—	—
4136523C92	Grille Assembly, Chrome	LT	—	—
4059083C93	Grille Assembly, Painted	LT	—	—
3832918C91	Grille Assembly, Primary, LH	LS, TG01	—	—
3832919C91	Grille Assembly, Primary, RH	LS, TG01	—	—
4134620C93	Grille Assembly, Chrome	RH	—	—
4073331C94	Grille Assembly, Bright with Bugscreen	HX	—	—
3551015C99	Grille Assembly, Chrome, 57" x 25"	3200, 4100, 4200, 4300, 4400, 7300, 7400, 8500, FBCB, FBTC, HVMD, MV, RXT	FLTG3551015	242-5107
3612816C97	Grille Assembly	APRO, PRO, PROL, PROP, RH	FLTG3612816	—



FLEETRITE

PN	DESCRIPTION	APPLICATION	DORMAN X-REF	TRP X-REF	FREIGHTLINER/MACK/VOLVO X-REF
FLTG3551015	Grille Assembly	International DuraStar®	—	—	—
FLTG3612816	Grille Assembly	International ProStar®	—	—	—
FLTGFCASC	Grille Assembly	Freightliner Cascadia	—	—	—
FLTGFCENT	Grille Assembly	Freightliner Century	—	—	—
FLTGFCOLU	Grille Assembly	Freightliner Columbia	—	—	—
FLTGPBBLG	Extended Grille	Peterbilt 379	—	—	—
FLTGPBBS2	Short Grille, SE	Peterbilt 379	—	—	—
FLTGVVNLAC	All Chrome Grille	Volvo VNL	—	—	—
FLTGHINOC	Grille, Chrome, No Screen	Hino	—	—	—
FLTGMCX	Grille Assembly	Mack CX	242-5502	GRMKVISPIN	6MF580M, 20791629
FLTGVVNLBC	Grille, Black and Chrome	Volvo VNL	242-5501A	—	85108862, 82373858, 20505759, 85122291, 82601906



GRILLE COMPONENTS



INTERNATIONAL

PN	DESCRIPTION	APPLICATION
3613675C95	Grille, Surround Assembly, Chrome	7300, 7400, 7500, 7600, 7700, CXT, HVHD, HVMD
3613683C91	Grille Assembly, Chrome, Fixed with Screen	7300, 7400, 7500, 7600, 7700, CXT, HVHD, HVMD
3565083C96	Grille, Surround Assembly	4100, 4200, 4300, 4400, 7300, 7400, HVMD, MV
3613676C95	Grille, Surround Assembly, Painted	7300, 7400, 7500, 7600, 7700, HVHD, HVMD
2517602C1	Clip, Rod	—
4071851C2	Grille, Bar, Assembly, First	HX
4123111C1	Grille Support	CV
4131349C92	Grille, Surround Assembly, LSFA	HX



FLEETRITE

PN	DESCRIPTION	APPLICATION	DORMAN X-REF	TRP X-REF	FREIGHTLINER/MACK/VOLVO X-REF
FLTGH3612816	Grille, Hardware	International ProStar®	—	—	—
FLTGHCASC	Grille, Hardware	Freightliner Cascadia	—	—	—
FLTGHCENT	Grille, Hardware	Freightliner Century	—	—	—
FLTGHCOLU	Grille, Hardware	Freightliner Columbia	—	—	—
FLTGDURA	Grille, Hardware	International DuraStar®	—	—	—
FLTGHMCX	Grille, Hardware	Mack CX	—	—	—
FLTGHVNLAC	Grille, All Chrome	Volvo VNL	—	—	—
FLTG3612816	Grille	International ProStar®	—	—	—
FLTG3551015	Grille	International DuraStar®	242-5107	—	—
FLTGFASC	Grille	Freightliner Cascadia	242-5201	GRFLCAS08	A17-19112-000, A17-15624-003, A17-19112-007, A17-19112-016



DOOR PARTS



INTERNATIONAL

PN	DESCRIPTION	APPLICATION	TRP X-REF	DORMAN X-REF	AUTOMANN X-REF
3550931C91	Outside Door Handle with Pawl, Metal with Zinc Chrome Finish	2500, 2600, 3000, 4700, 4800, 4900, 5000, 5500, 5600, 5900, 8100, 8500, 9100, 9200, 9300, 9400, 9800, 9900	DRH051004	760-5101	HLK2055
3550930C91	Outside Door Handle with Pawl, Metal with Zinc Chrome Finish	5000, 5500, 5600, 5900, 9100, 9200, 9300, 9400, 9800, 9900	DRH051003	760-5110	HLK2055
3747736C1	Outside Door Handle, RH, Black	3200, 4100, 4200, 4300, 4400, 7300, 7400, 7500, 7600, 7700, 8500, 8600, CACB, CXT, MIL1, MXT, NC2, PRO, PROL, PROP, RXT, TR01	760-5108	HLK1073HDR	—
3747735C1	Key Lock Hole with Black Lever, Plastic with Black Finish Handle	3200, 4100, 4200, 4300, 4400, 7300, 7400, 7500, 7600, 7700, 8500, 8600, CACB, CASB, CXT, MIL1, MXT, NC2, PRO, PROL, PROP, RXT, TR01	—	760-5107	HLK1073HDL
4053943C93	Door Handle, Outside, LH	CACB, EVMV, HVHD, HVMD, HX, LT, MV, RH	—	—	—
4072904C2	Door Handle, Outside, LH Assembly	HX	—	—	—
3747731C1	Key Lock Hole, Plastic with Black and Chrome Finish, Chrome Handle	7600, APRO, NC2, PRO, PROL, PROP, TG01	—	760-5106	HLK1069HDC
3747732C1	Key Lock Hole, Plastic with Black and Chrome Finish, Chrome Handle	7600, APRO, NC2, PRO, PROL, PROP, TG01	—	760-5105	HLK1070HDC
4053944C93	Outside Door Handle, RH	EVMV, HVHD, HVMD, HX, LT, MV, RH	—	—	—
4053946C93	Outside Door Handle, RH	CACB, EVMV, HVHD, HVMD, HX, LS, LT, MV, RH	—	—	—
1669265C1	Outside Door Handle	2500, 2600, 3000, 4700, 4800, 4900, 8100, 8500	—	—	—
3747733C1	Outside Door Handle, LH	TG01	—	—	—
3747734C1	Outside Door Handle, RH	TG01	—	—	—
4072917C1	Outside Door Handle, Housing	HX	—	—	—



FUEL TANK



INTERNATIONAL

PN	DESCRIPTION	APPLICATION
1661790C93	50 Gallon, Aluminum, Steel	2500, 2600, 4700, 4800, 4900, 5500, 5600
2506440C93	70 Gallon, Aluminum, Stainless Steel, Black, D-Type	4200, 4300, 4400, 7300, 7400, 7500, 7600, 8500
3752732C92	70 Gallon, LSM, 19", D-Type	4300, 4400, 7300, 7400, 7500, 7600, FBTC, HVHD, HVMD, MV
2516139C91	100 Gallon, 26"	LS, LT, PRO, RH
2506435C92	70 Gallon, D-Type	3800, 4200, 4300, 4400, 7300, 7400, 7500, 7600, 8500, FBTC
4184214C2S	100 Gallon, 26"	LS, LT, RH
4184232C2S	100 Gallon, 26"	LT, PRO
4172932C1S	80 Gallon, 26"	7300, 7400, 7500, 7600, HVHD, HVMD, PRO, PROP

ALL-MAKES

PN	DESCRIPTION	APPLICATION
2506434C92	50 Gallon, D-Type	4100, 4200, 4300, 4400, 5500, 5600, 7300, 7400, 7500, 7600, 8500, CACB, FBCB, J650, J750, SFCB
2506439C92	50 Gallon, D-Type	3200, 4200, 4300, 4400, 7300, 7400, 7500, 7600, 8500, CACB, J650, J750
2510700C93	100 Gallon, 26"	660, 7600, 8600, 9900, HVHD, HVMD, LT, PRO, RH, TG01
4026514C93	100 Gallon, 26"	660, LS, LT, PRO
2506431C92	35 Gallon	CF50, CF60, J650, JCF5, JCF6, SFCB
2508976C93	65 Gallon, D-Type	J650, J750

FUEL TANK ACCESSORIES



INTERNATIONAL

PN	DESCRIPTION	APPLICATION	DORMAN X-REF	AUTOMANN X-REF
3536370C2	Steel Upper Side, 704mm, Black	3200, 3800, 4100, 4200, 4300, 4400, 7300, 7400, 7500, 7600, 7700, 8500, 8600, CACB, CXT, FBTC, HVHD, HVMD, J650, J750	157-5101	M55371
3578201C1	Side Step, 832mm, Aluminum	3200, 3800, 4100, 4200, 4300, 4400, 7300, 7400, 7500, 7600, 7700, 8500, 8600, CACB, CV, CXT, FBTC, GM, HVHD, HVMD, J650, MV, PRO, RH	157-5104	M55201
3578200C1	Steel Upper Side, 704mm, Black	3200, 3800, 4100, 4200, 4300, 4400, 7300, 7400, 7500, 7600, 7700, 8500, 8600, CACB, CV, CXT, FBTC, GM, HVHD, HVMD, MV, PRO	157-5106	M55200
3536371C2	Steel, 832mm, Black	3200, 3800, 4100, 4200, 4300, 4400, 7300, 7400, 7500, 7600, 7700, 8500, 8600, CACB, CXT, FBTC, HVHD, J650, J750, RXT	157-5101	M55371
2643614R1	Lining Fuel Tank Strap, 10'	2500, 2600, 3000, 3047, 3200, 3800, 4100, 4200, 4300, 4400, 4700, 4800, 4900, 5000, 5500, 5600, 5900, 660, 680, 7300, 7400, 7500, 7600, 7700, 8100, 8500, 8600, 9800, 9900, APRO, CACB, CF50, CF60, CV, CXT, FBCB, FBTC, GM, HVHD, HVMD, HX, J650, J750, JCF5, JCF6, LS, LT, MIL, MIL1, MIL2, MV, NC2, PRO, PROL, PROP, RH, RXT, SFCB, TG01, TR01	—	—
596590C1	Lining, 1'	2500, 2600, 3000, 30FE, 30IC, 30RE, 3200, 3300, 3600, 3800, 4100, 4200, 4300, 4400, 5000, 5500, 5600, 5900, 660, 680, 7300, 7400, 7500, 7600, 8100, 8600, 9100, 9200, 9300, 9400, 9800, 9900, BE20, CACB, CASB, EVSB, FBCB, FECB, FESB, HVHD, HVMD, HX, IC Bus, J650, LT, MV, NC2, PRO, RECB, RESB, TG01, TR01	—	—
3555266R1	Lining Fuel Tank Strap, 1'	2500, 2600, 5000, 5500, 5600, 5900, 7300, 7400, 7500, 7600, 7700, 8100, 9100, 9200, 9300, 9400, 9800, 9900, HVHD, J650, J750, MIL1	—	—
3591619C2	Fuel Tank Cap, Non-Locking	4300, 7300, 7400, 7500, 7600, 8600, 9200, 9400, 9900, HVHD, HVMD, LS, LT, MIL, MIL1, MV, PRO, PROP, RH, TG01	—	—
3559312C2	Fuel Tank Cap, Non-Locking	2500, 2600, 4300, 4400, 5000, 5500, 5600, 5900, 660, 680, 7300, 7400, 7500, 7600, 8100, 8600, 9100, 9200, 9300, 9400, 9900, HVHD, HVMD, HX, J650, J750, LS, LT, MV, NC2, PRO, PROL, PROP, RH, TG01	—	—
3591621C2	Fuel Tank Cap, Non-Locking	4300, 7400, 7500, 7600, 8600, 9200, 9400, 9900, HVHD, HVMD, LS, LT, MV, PRO, PROL, PROP, RH, TG01	—	—
3591620C2	Fuel Tank Cap, Non-Locking	2600, 4300, 4400, 5000, 5500, 5600, 5900, 660, 680, 7300, 7400, 7500, 7600, 8100, 8600, 9200, 9300, 9400, 9900, APRO, HVHD, HVMD, HX, LS, LT, MV, NC2, PRO, PROL, PROP, RECB, RESB, RH, TG01	—	—
3571060C1	Steel Side Step, Heavy-Duty, 896mm, Black	3200, 4300, 4400, 7300, 7400, 7500, 7600, 7700, 8500, 8600, CACB, CASB, FBTC, HVHD, MV, RH, RXT, TR01	157-5102	M55060

FUEL TANK ACCESSORIES (CONT'D)



ALL-MAKES		
PN	DESCRIPTION	APPLICATION
3533425C3	Fitting Fuel Outlet, 90 Degree Elbow, Voss	1652, 3000, 3200, 3300, 3800, 4100, 4200, 4300, 4400, 5500, 5600, 5900, 7300, 7400, 7500, 8500, 8600, 9200, 9400, 9900, APRO, BE20, CACB, CASB, CXT, EVSB, FBCB, FBTC, FECB, FESB, HVMD, IC Bus, J650, J750, LS, LT, MIL, MIL1, MIL2, MV, MXT, NC2, PRO, PROL, PROP, RECB, RESB, RXT, SFCB, TG01, TR01
3533106C3	Strap Fuel Tank Mounting, Assembly of ST	3200, 4100, 4200, 4300, 4400, 5500, 5600, 7300, 7400, 7500, 7600, 8500, CACB, HVHD, HVMD, J650, J750, MV
3533426C3	Fitting Fuel Outlet, Straight Voss	1652, 2500, 2600, 3000, 3200, 3300, 4100, 4200, 4300, 4400, 4800, 5000, 5500, 5600, 5900, 7300, 7400, 7500, 8100, 8500, 8600, 9100, 9200, 9300, 9400, 9800, 9900, APRO, BE20, CACB, CASB, CXT, EVSB, FBCB, FBTC, FECB, FESB, HVMD, IC Bus, J650, J750, MIL, MIL2, MV, MXT, NC2, PRO, PROL, PROP, RECB, RESB, RXT, SFCB, TG01, TR01
4070308C1	Strap Fuel Tank Mounting, Step Mounting	680, HX
2595624C91	Sensor, Water In Fuel	CF50, CF60, JCF5, JCF6
BA0B001250	Tube Fuel Line, Plastic or Nylon	J650, J750
4045291C1	Strap, Fuel Tank Mounting	J650
3548221C2	Cap Assembly, 2", Non-Locking	3000, 30FE, 30IC, 30RE, 3200, 3300, 3800, 4100, 4200, 4300, 4400, 5500, 5600, 7300, 7400, 7500, 7600, 7700, 8500, BE20, CACB, CASB, CF50, CF60, CXT, EVSB, FBCB, FBTC, FECB, FESB, HVHD, HVMD, IC Bus, J650, J750, JCF5, JCF6, MV, RECB, RESB, RXT, SFCB, TR01
3592790C1	Cap Fuel Tank 3", Non-Locking, 2 Each	660, 680, 9200, 9400, 9900, HX, LS, LT, PRO, PROL, PROP, RH, TG01

BATTERY BOXES



BATTERY BOX ASSEMBLIES		
PN	DESCRIPTION	APPLICATION
3725637C3	Box, Battery, 30" x 22" Weld	PRO
3774010C4	Box, Battery, Tray	CV, GM
3883222C1	Box, Battery	CACB, CASB, TR01
3889096C1	Box, Battery	CACB, TR01
4024527C2	Box, Battery, 30" x 22" Weld	PRO
4098348C92	Box, Battery	HX

TRAYS AND COVERS		
PN	DESCRIPTION	APPLICATION
3535374C2	Cover, Battery Box	3200, 3800, 4100, 4200, 4300, 4400, 7300, 7400, 7500, 7600, 7700, 8500, 8600, CACB, CASB, CXT, FBTC, HVHD, HVMD, J650, J750, MV, MXT, RXT, TR01
2509599C92	Cover and Seal Assembly, HDLT Bulb	3200, 3300, 4100, 4200, 4300, 4400, 7300, 7400, 7500, 7600, 7700, 8500, 8600, BE20, CACB, CXT, EVSB, FBCB, FBTC, HVHD, HVMD, IC Bus, MIL, MIL1, MV, NC2, RXT
3578369C2	Cover, Battery Box	2500, 2600, 4300, 4400, 5500, 5600, 5900, 660, 680, 7300, 7400, 7500, 7600, 7700, 8100, 8500, 8600, 9100, 9200, 9400, 9800, CACB, FBTC, HVHD, HVMD, HX, LT, MIL1, MV, PRO
3616253C1	Cover, Fuse Box with Gasket	3200, 4100, 4200, 4300, 4400, 7300, 7400, 7500, 7600, 7700, 8500, 8600, CACB, CXT, RXT
3534954C3	Tray, Battery	3200, 3800, 4100, 4200, 4300, 4400, 7300, 7400, 7500, 7600, 7700, 8500, 8600, CACB, CXT, FBTC, J650, J750, RXT
3557573C3	Tray, Battery	4300, 4400, 5600, 5900, 7300, 7400, 7500, 7600, 7700, 8500, 8600, CACB, FBTC, HVHD, HVMD, HX, MIL1, MV
2519458C1	Cover, Vent Hole	4600, 4400, 7300, 7400, 7500, CACB, LT, RH
3832318C2	Cover, Secondary Instrument Cluster Gauge, Black Bezel	7600, PRO, PROL, PROP
4025236C1	Cover, Shield, Battery Box	4400, 5900, 660, 680, 7300, 7400, 7500, 7600, 8600, 9900, HVHD, HVMD, HX, LS, LT, MV, PRO, RH, TG01
3999393C4	Cover, 30", Battery Box, Plastic	4400, 660, 680, 7300, 7400, 7500, 7600, 8600, 9900, HVHD, HVMD, HX, LS, LT, MV, PRO, RH, TG01
2029260C2	Tray, Battery Box, 4700	2500, 2600, 3000, 4700, 4800, 4900, 8100, 8500, CF50, CF60, JCF5, JCF6
3596208C91	Cover, Battery Box	9200, 9400
3993048C1	Slide, Battery Box, 14"	BE20, EVSB, IC Bus, RECB, RESB
2586076C91	Cover Assembly, Tail/Stop Light Bulb Socket	3200, 3300, 4100, 4200, 4300, 4400, 7300, 7400, 7500, 7600, 7700, 8500, 8600, BE20, CACB, CASB, CXT, EVSB, FBCB, FBTC, HVMD, IC Bus, MV, NC2, RXT, TR01

BATTERY BOXES (CONT'D)



MOUNTS AND HARDWARE

PN	DESCRIPTION	APPLICATION
3553499C2	Clamp, Battery Hold Down	3200, 3800, 4100, 4200, 4300, 4400, 7300, 7400, 7500, 7600, 7700, 8500, 8600, CACB, CASB, CXT, FBTC, HVHD, HVMD, J650, J750, MV, MXT, RXT, TR01
3557584C1	Clamp, Battery Hold Down	4300, 4400, 5600, 5900, 660, 680, 7300, 7400, 7500, 7600, 7700, 8500, 8600, CACB, FBTC, HVHD, HVMD, HX, MILI, MV, PRO
1664297C4	Clamp, Battery Hold Down	2500, 2600, 3000, 4300, 4400, 4700, 4800, 4900, 5500, 5600, 5900, 7300, 7400, 7500, 7600, 7700, 8100, 8500, CF50, CF60, HVHD, HVMD, HX, JCF5, JCF6, MV
481321C1	Clamp, Battery Hold Down	5000, 5500, 5600, 5900, 9100, 9200, 9300, 9400, 9900, PRO, TG01
4058420C1	Latch, Handle, Plastic Battery Box	LS, LT, MV, PRO, RH, TG01
3994043C2	Clamp, Battery Hold Down, 3 Group	BE20, CV, GM, HVHD, HVMD, IC Bus, RECB, RESB, RH
3508628C1	Clamp, Battery Hold Down	5500, 5600, 5900, 9100, 9200, 9400, 9900
3561780C1	Clamp, Cable, SGL Coated, 2	1652, 3000, 301C, 3800, 4700
3539667C1	Clamp, Battery Hold Down	4300, 4400, 7300, 7400, 7500, 7600, 7700, 8500, CACB, HVMD, MV
4056191C1	Latch, Leespring LHC 148U03S	LS, LT, MV, PRO, RH, TG01
4050045C1	Latch, Striker, 30" Battery	8600, 9900, LT, PRO, RH, TG01
4058423C2	Latch, Shaft, Plastic Battery Box	LS, LT, MV, PRO, RH, TG01
3616004C1	Clamp Assembly, Battery Hold Down	660, 8600, NC2, PROP
3553500C2	Clamp, Battery Hold Down	4300, 4400, 5000, 5500, 5600, 5900, 7300, 7400, 7500, 7600, 7700, 8500, 8600, 9800
481320C1	Clamp, Battery Hold Down	5000, 9100, 9200, 9300, 9400, 9900, PRO, TG01
1670134C1	Clamp Assembly, Battery Hold Down	9100, 9200, 9400
1666643C1	Clamp, Battery Hold Down	5000, 5500, 5600, 5900, 9100, 9200, 9400, 9800, 9900
1666784C1	Clamp, Multi-Battery Cable	5000, 5500, 5600, 5900, 9100, 9200, 9400, 9800, 9900
299261C91	Clamp, Rubber Cushioned	2500, 2600, 301C, 3200, 4100, 4200, 5000, 5500, 5600, 5900, 660, 680, 7300, 7400, 7600, 9100, 9200, 9300, 9400, 9800, 9900, CACB, CASB, CV, FBTC, FESB, GM, J650, J750, LS, RECB, RESB, RXT, SFCB, TG01, TR01

EXTERIOR ACCESSORIES



AXLE COVERS, NUT COVERS AND RELATED TOOLS

INTERNATIONAL	DESCRIPTION	DIAMETER (INCH)	LENGTH (INCH)	WIDTH (INCH)	HEIGHT (INCH)	WEIGHT (LB)	ROAD MASTER	GRAND GENERAL	UNITED PACIFIC
FLTCR11755	19.5" Wheel Simulator Set, Universal Fit, 275mm Bolt Circle, 8 Lugs, 4 Hand Holes, 33mm Nut Covers, Over-the-Lug Mounting, Stainless Steel	20.50	—	—	8.30	22.00	—	—	21407P
FLTCR14482	Mud Flap Bottom Weight, 3" x 18", Stud Mount, Chrome	—	18.00	3.00	—	2.00	610CD	—	21411P
FLTCR14491	Bottom Weight, 4" x 24", Stud Mount, Stainless	—	24.00	4.00	—	2.45	615S	30032	10416CP
FLTCR14492	Bottom Weight, 4" x 24", Stud Mount, Chrome	—	24.00	4.00	—	3.04	615CD	—	21409P
FLTCR14493	Bottom Weight, 4" x 24", Stud Mount, Stainless	—	24.00	4.00	—	3.00	615SCD	—	—
FLTCR14510	Bottom Weight, 4" x 24", Hardware Mount, Chrome	—	24.00	4.00	—	2.90	616	30170	—
FLTCR14512	Bottom Weight, 4" x 24", Hardware Mount, Chrome	—	24.00	4.00	—	3.04	616CD	—	10260
FLTCR14513	Bottom Weight, 4" x 24", Hardware Mount, Stainless	—	24.00	4.00	—	2.60	616SCD	—	—
FLTCR14562	Bottom Weight, 4" x 24", Stud Mount, Chrome	—	24.00	4.00	—	4.00	635CD	—	—
FLTCR15100	ABS Front Cover Kit, Removable Cap, 10 Lugs, 33mm Threads, with Flange	13.75	—	—	3.25	2.31	214PP	40134	—
FLTCR15200	ABS Front Cover Kit, Removable Cap, 10 Lugs, 33mm Nut Cover Size, Push-on, with Flange	14.00	—	—	4.00	2.30	—	—	10264
FLTCR15300	Front Axle Cover Kit, 5-Spoke, 10 Lugs, 33mm Nut Cover Size, Threaded	13.75	—	—	3.75	3.00	—	—	—
FLTCR15500	ABS Rear Cover Kit, Removable Cap, 10 Lugs, 1.5" Nut Cover Size, Push-on, with Flange	—	—	—	—	3.75	—	—	—
FLTCR15600	ABS Rear Cover Kit, Removable Cap, 10 Lugs, 33mm Nut Cover Size, Threaded, with Flange	13.75	—	—	8.75	7.50	344P	40144	10264
FLTCR15700	ABS Rear Axle Cover Kit, Removable Cap, 10 Lugs, Short 33mm Nut Cover Size, Push-on, with Flange	13.75	—	—	9.00	7.50	—	—	—
FLTCR15985	Plastic Rim Protector for ABS Cover Kits	13.98	—	—	0.03	0.01	.365	80510	10128
FLTCR16112	Front Hubcap, 4-Notch, 8.72" Outside Diameter, 2.375" Height, Chrome, Baby Moon	8.72	—	—	2.38	1.00	—	—	10691P
FLTCR16160	Front Hubcap, 4 Notch, 8.72" Outside Diameter, 2.56" Height, Chrome, Baby Moon	8.72	—	—	2.56	0.68	—	10503	—
FLTCR16161	Front Cap, 4 Notch, 8.72" Outside Diameter, 2.56" Height, Stainless, Baby Moon	8.72	—	—	2.56	0.55	—	—	—
FLTCR16162	Front Cap, 4 Notch, 8.72" Outside Diameter, 2.56" Height, Chrome, Baby Moon	8.72	—	—	2.56	1.00	—	10513SP	—
FLTCR16163	Front Cap, 4 Notch, 8.72" Outside Diameter, 2.56" Height, Stainless, Baby Moon	8.72	—	—	2.56	0.87	—	—	—
FLTCR16180	Front Cap, 5 Notch, 8.72" Outside Diameter, 2.56" Height, Chrome, Baby Moon	8.72	—	—	2.56	0.60	—	10514	10099P
FLTCR16181	Front Cap, 5 Notch, 8.72" Outside Diameter, 2.56" Height, Stainless, Baby Moon	8.72	—	—	2.56	0.50	—	—	2099P
FLTCR16182	Front Cap, 5 Notch, 8.72" Outside Diameter, 2.56" Height, Chrome, Baby Moon	8.72	—	—	2.56	1.00	—	10514SP	10111

EXTERIOR ACCESSORIES (CONT'D)



AXLE COVERS, NUT COVERS AND RELATED TOOLS (CONT'D)									
INTERNATIONAL	DESCRIPTION	DIAMETER (INCH)	LENGTH (INCH)	WIDTH (INCH)	HEIGHT (INCH)	WEIGHT (LB)	ROAD MASTER	GRAND GENERAL	UNITED PACIFIC
FLTCR16183	Front Cap, 5 Notch, 8.72" Outside Diameter, 2.56" Height, Stainless, Baby Moon	8.72	—	—	2.56	0.90	—	10508SP	20011
FLTCR16243	Front Cap, 6 Notch, 8.72" Outside Diameter, 3.08" Height, Stainless, Conical	8.72	—	—	3.08	1.00	208SCD-2	—	2011P
FLTCR16250	Front Cap, 6 Notch, 8.72" Outside Diameter, 3.08" Height, Chrome, Baby Moon	8.72	—	—	2.56	0.50	208	10760	—
FLTCR16252	Front Cap, 6 Notch Uneven, 8.72" Outside Diameter, 3.08" Height, Chrome, Baby Moon	8.72	—	—	2.56	1.00	208CD	—	10110P
FLTCR16700	Trailer Hubcap with 3 Clips, 9.25" Inside Diameter, 2.63" Height, Chrome, Baby Moon	9.65	—	—	2.63	0.80	330	10560	10209P
FLTCR16701	Trailer Hubcap with 3 Clips, 9.25" Inside Diameter, 2.63" Height, Stainless, Baby Moon	9.65	—	—	2.63	0.80	330S	10561	10201
FLTCR16902	Rear Hubcap, 7.25" Inside Diameter, 2.63" Height, Chrome, Baby Moon	7.85	—	—	2.63	1.00	300CD	20010SP	20203
FLTCR16930	Rear Hubcap, 8" Inside Diameter, 2.75" Height, Chrome, Baby Moon	8.40	—	—	2.75	0.70	310	20020	10203
FLTCR16931	Rear Hubcap, 8" Inside Diameter, 2.75" Height, Stainless, Baby Moon	8.40	—	—	2.75	0.50	310S	20023	20203
FLTCR16932	Rear Hubcap, 8" Inside Diameter, 2.75" Height, Chrome, Baby Moon	8.40	—	—	2.75	0.96	310CD	20020SP	10203P
FLTCR16933	Rear Hubcap, 8" Inside Diameter, 2.75" Height, Stainless, Baby Moon	8.40	—	—	2.75	0.75	310SCD	20023SP	—
FLTCR16950	Rear Hubcap, 8.19" Inside Diameter, 2.75" Height, Chrome, Baby Moon	8.75	—	—	2.88	0.78	320	20030	—
FLTCR16951	Rear Hubcap, 8.19" Inside Diameter, 2.75" Height, Stainless, Baby Moon	8.75	—	—	2.88	0.55	320S	20033	—
FLTCR16952	Hand Holes, Stainless Steel, Axle Mounting Bracket Included	8.75	—	—	2.88	1.00	320CD	20030SP	—
FLTCR16953	Rear Hubcap, 8.19" Inside Diameter, 2.75" Height, Stainless, Baby Moon	8.75	—	—	2.88	0.77	320SCD	20033SP	—
FLTCR16954	Rear Hubcap, 8.19" Inside Diameter, 3.13" Height, Chrome, Baby Moon	8.75	—	—	3.13	0.68	—	—	—
FLTCR16955	Rear Hubcap, 8.19" Inside Diameter, 3.13" Height, Stainless Steel, Baby Moon	8.75	—	—	3.13	0.68	—	—	10240
FLTCR16956	Rear Hubcap, 8.19" Inside Diameter, 3.13" Height, Chrome, Baby Moon	8.75	—	—	3.13	0.92	—	—	10240P
FLTCR16957	Rear Hubcap, 8.19" Inside Diameter, 3.13" Height, Stainless Steel, Baby Moon	8.75	—	—	3.13	0.70	326S	20035	—
FLTCR16970	Rear Hubcap, 8.06" Inside Diameter, 2.75" Height, Chrome, Baby Moon	8.39	—	—	2.75	0.50	326	20034	—
FLTCR16972	Rear Hubcap, 8.06" Inside Diameter, 2.75" Height, Chrome, Baby Moon	8.39	—	—	2.75	1.00	326CD	—	—
FLTCR16973	Rear Hubcap, 8.06" Inside Diameter, 2.75" Height, Stainless, Baby Moon	8.39	—	—	2.75	1.00	326SCD	—	—
FLTCR17000	Rear Hubcap, 6.5" Inside Diameter, 2.5" Height, Chrome, Baby Moon	6.80	—	—	2.50	0.52	326	20034	10106
FLTCR17020	Front Hubcap, 4-Notch Short Lip, 8.72" Outside Diameter, 2.56" Height, Chrome, Baby Moon	8.72	—	—	2.56	0.52	203	10513	10094
FLTCR17021	Front Hubcap, 4-Notch Short Lip, 8.72" Outside Diameter, 2.56" Height, Stainless, Baby Moon	8.72	—	—	2.56	0.48	250S-1	—	20094
FLTCR17022	Front Hubcap, 4-Notch Short Lip, 8.72" Outside Diameter, 2.56" Height, Chrome, Baby Moon	8.72	—	—	2.56	0.71	203CD	—	10094P
FLTCR17023	Front Hubcap, 4-Notch Short Lip, 8.72" Outside Diameter, 2.56" Height, Stainless, Baby Moon	8.72	—	—	2.56	0.67	203SCD	—	—
FLTCR17025	Front Hubcap, 5-Notch, Short Lip, 8.72" Outside Diameter, 2.56" Height, Chrome, Baby Moon	8.72	—	—	2.56	0.52	204	10514	10205P
FLTCR17027	Front Hubcap, 5-Notch, Short Lip, 8.72" Outside Diameter, 2.56" Height, Chrome, Baby Moon	8.72	—	—	2.56	1.00	204CD	—	—
FLTCR17122	Rear Hubcap, 8" Inside Diameter, 2.13" Height, Stainless Steel, Hubdometer	8.39	—	—	2.13	0.75	315CD	90360SP	10205P
FLTCR17132	Rear Hubcap, 8.19" Inside Diameter, 2.25" Height, Chrome, Hubdometer	8.74	—	—	2.25	0.75	325CD	90370SP	10206P
FLTCR17540	Nut Cover, 1.25" Diameter, 1-7/8" Height, for Dayton Wheels, Chrome	1.25	—	—	1.88	0.03	115	10110	—
FLTCR17542	Nut Cover, 1.25" Diameter, 1-7/8" Height, for Dayton Wheels, Chrome	1.25	—	—	1.88	1.30	115CD	10110SP	10001P
FLTCR17570	Nut Cover, 1.5" Diameter, 1-5/8" Height, Chrome	1.50	—	—	1.63	0.06	105	10010	10004
FLTCR17572	Nut Cover, 1.5" Diameter, 1-5/8" Height, Chrome	1.50	—	—	1.63	1.30	105-10	—	10080P
FLTCR17573	Nut Cover, 1.5" Diameter, 1-5/8" Height, Stainless Steel	1.50	—	—	1.63	1.30	105S-10	—	—
FLTCR17590	Nut Cover, 1.5" Diameter, 2" Height, Bullet Style, Chrome	1.50	—	—	2.00	0.06	110	10020	—
FLTCR17592	Nut Cover, 1.5" Diameter, 2" Height, Bullet Style, Chrome	1.50	—	—	2.00	1.30	110-10	—	10027P
FLTCR17593	Nut Cover, 1.5" Diameter, 2" Height, Bullet Style, Stainless Steel	1.50	—	—	2.00	1.30	110S-10	—	—
FLTCR17800	Nut Cover, 33mm Diameter, 50mm Height, Bullet Style with Flange, Chrome	1.30	—	—	1.97	0.06	111	10270	1005
FLTCR17801	Nut Cover, 33mm Diameter, 50mm Height, Bullet Style with Flange, Stainless Steel	1.30	—	—	1.97	0.06	111S	10272	—
FLTCR17802	Nut Cover, 33mm Diameter, 50mm Height, Bullet Style with Flange, Chrome	1.30	—	—	1.97	1.30	111-10	—	—
FLTCR17803	Nut Cover, 33mm Diameter, 50mm Height, Bullet Style with Flange, Stainless Steel	1.30	—	—	1.97	1.30	111S-10	—	—
FLTCR17806	Nut Cover, 33mm Diameter, 64mm Height, Tall Boy, with Flange, Chrome	1.30	—	—	2.52	0.07	—	—	—
FLTCR17807	Nut Cover, 33mm Diameter, 64mm Height, Tall Boy, with Flange, Stainless Steel	1.30	—	—	2.52	0.07	—	—	10061
FLTCR18000	ABS Chrome Nut Cover, 1.5" Diameter, 2.75" Height, Push-on, with Flange	1.50	—	—	2.75	0.06	104P	10024	—
FLTCR18002	ABS Chrome Nut Cover, 1.5" Diameter, 2.75" Height, Push-on, with Flange	1.50	—	—	2.75	1.30	104P-10	—	—
FLTCR18010	ABS Chrome Nut Cover for ABS Axle Cover Sets, 1.5" Diameter, 2.75" Height, Push-on	1.50	—	—	2.75	0.06	—	10023	—
FLTCR18012	ABS Chrome Nut Cover, 1.5" x 2.75" Push-on for Axle Cover Kit	1.50	—	—	2.75	1.30	—	—	—
FLTCR18100	ABS Chrome Nut Cover, 33mm x 2.88" Twist-on with Flange	1.30	—	—	2.88	0.08	111PFL	10326	10064B
FLTCR18102	ABS Chrome Nut Cover, 33mm x 2.88" Twist-on with Flange	1.30	—	—	2.88	0.96	111PFL-10	—	10064
FLTCR18104	ABS Chrome Nut Cover, 33mm x 2.88" Twist-on with Flange	1.30	—	—	2.88	0.09	111PFL	10326	10064B

EXTERIOR ACCESSORIES (CONT'D)



AXLE COVERS, NUT COVERS AND RELATED TOOLS (CONT'D)

INTERNATIONAL	DESCRIPTION	DIAMETER (INCH)	LENGTH (INCH)	WIDTH (INCH)	HEIGHT (INCH)	WEIGHT (LB)	ROAD MASTER	GRAND GENERAL	UNITED PACIFIC
FLTCR18200	ABS Chrome Nut Cover, 33mm x 2.88" Push-on with Flange	1.30	—	—	2.88	0.07	—	—	—
FLTCR18202	ABS Chrome Nut Cover, 33mm x 2.88" Push-on with Flange	1.30	—	—	2.88	0.88	—	—	—
FLTCR18204	ABS Chrome Nut Cover, 33mm x 2.88" Push-on with Flange	1.30	—	—	2.88	0.07	—	—	—
FLTCR18210	ABS Chrome Nut Cover, 33mm x 2.5" Bullet Style, Push-on with Flange	1.30	—	—	2.50	0.10	111P	10267	10049B
FLTCR18212	ABS Chrome Nut Cover, 33mm x 2.5" Bullet Style, Push-on with Flange	1.30	—	—	2.50	1.30	111P-10	—	—
FLTCR18300	ABS Chrome Nut Cover, 33mm x 2.88" Push-on with Flange	1.30	—	—	2.88	0.06	—	—	—
FLTCR18302	ABS Chrome Nut Cover, 33mm x 2.88" Push-on with Flange	1.30	—	—	2.88	1.30	—	—	—
FLTCR18350	ABS Chrome Nut Cover, 33mm x 3.31" Tall Boy, Push-on with Flange	1.30	—	—	3.31	0.06	112P	10261	10059B
FLTCR18400	Nut Cover Wrench for Installation or Removal of 1.5" Nut Covers	—	—	—	—	0.62	100	90251	90007
FLTCR18701	Standard Bumper Guides, 48" Length, Flat Clamp, Stainless, Pair	—	48.00	—	—	3.00	—	—	—
FLTCR18750	Standard Bumper Guides, 48" Length, G-Clamp, Chrome, Pair	—	48.00	—	—	2.70	—	—	—
FLTCR18940	Bumper Guide Replacement Parts, Standard Amber Lens, Pair	—	—	—	—	0.02	848-2A	—	30756
FLTCR18960	Bumper Guide Replacement Parts, Repair Kit, with Sockets, Bulb, Wiring Hardness	—	—	—	—	0.25	848-4	—	94163
FLTCR18971	Bumper Guide Replacement Parts, Standard Threaded Collar, Stainless	—	—	—	—	0.20	—	—	—
FLTCR19911	Permit Holders, 18" Length, 5" Height, Hinged, Stainless	—	18.00	—	5.00	5.20	426H	60781	—
FLTCR20121	License Plate Holders, 39" Length, 8" Height, 3 License, Stainless	—	39.00	—	8.00	5.70	440S	—	21540
FLTCR20202	License Plate Holders, 18" Length, 10" Height, 2 Mounts, 2 License, 2 Lights, Chrome	—	18.00	—	10.00	10.50	—	—	—
FLTCR21851	2-Piece Spring-Loaded Light Bar, 30.75" Length, 6.38" Height, 3.38" Width, Stainless	—	30.75	3.38	6.38	14.50	480S-SL	80310	22237
FLTCR21960	Spring-Loaded Mudflap Hanger, 30" Length, 2.5" Pattern, Straight, Chrome	—	30.00	—	—	12.50	646-SL	30573	10653
FLTCR21961	Spring-Loaded Mudflap Hanger, 30" Length, 2.5" Pattern, Straight, Stainless	—	30.00	—	—	12.50	646S-SL	30574	10654
FLTCR21990	Spring-Loaded Mudflap Hanger, 30" Length, 45 Degree Angle, 1.125" Pattern, Chrome	—	30.00	—	—	12.30	—	30560	—
FLTCR22012	Spring-Loaded Mudflap Hanger, 27" Length, 45 Degree Angle, 1.125" Pattern, Black	—	27.00	—	—	10.00	648B-SL	—	—
FLTCR22170	Anti-Sail Bracket, 24" Length, 21" Height, Chrome	—	24.00	—	21.00	2.43	640	30510	10451
FLTCR22171	Anti-Sail Bracket, 24" Length, 21" Height, Stainless	—	24.00	—	21.00	1.65	640S	30516	22451
FLTCR23800	Boot Brush, 7.5" Length, 2" Height, Black	—	8.50	2.87	2.00	1.40	—	—	—
FLTCR40000	ABS Front Axle Cover Kit with Non-Removable Cap, 10 Lug, 33mm, Threaded	13.90	—	—	3.38	3.50	—	—	—
FLTCR80031	Front Wheel Cover, 22.5", Stud-Pilot, 10 Lug, 2 Hand Holes, Chrome	22.50	—	—	2.02	4.31	—	—	—
FLTCR81003	Front Axle Cover Kit with Non-Removable Baby Moon Cap, 3.5" Height, (5) 1", (5) 1.88" Lug, Hub-Piloted, Chrome	13.50	—	—	3.50	2.20	—	—	—
FLTCR81021	Front Axle Cover Kit with Removable Baby Moon Cap, 3.5" Height, (5) 1.25", (5) 1.75" Lug, Stub-Piloted, Chrome	13.50	—	—	3.50	2.76	—	—	—
FLTCR83133	Rear Axle Cover Kit with Non-Removable Baby Moon Cap, 9.5" Height, (5) 1", (5) 1.88" Lug, Hub-Piloted, Chrome	13.50	—	—	9.50	4.41	—	—	—
FLTCR83143	Rear Axle Cover Kit with Non-Removable Baby Moon Cap, 9.5" Height, (5) 1", (5) 1.88" Lug, Hub-Piloted, Stainless	13.50	—	—	9.50	4.41	345S-354S	40121	21223
FLTCR83161	Rear Axle Cover Kit with Removable Baby Moon Cap, 10.5" Height, (5) 1.25", (5) 1.75" Lug, Stub-Piloted, Stainless	13.50	—	—	10.50	4.50	340S	10549	21212
FLTCR84031	Front Wheel Simulator, 22.5" x 8.25", 11.25" B.C., 10 Lug, 2 Hand Holes, Stud-Piloted, Stainless	22.50	—	—	3.31	4.08	—	—	—
FLTCR86021	Front Wheel Simulator Kit, 22.5" x 8.25", 11.25" B.C., 10 Lug, 2 Hand Holes, Stud-Piloted, Stainless	22.50	—	—	3.25	10.00	—	—	—
FLTCR86023	Front Wheel Simulator Kit, 22.5" x 8.25", 11.25" B.C., 10 Lug, 2 Hand Holes, Hub-Piloted, Stainless	22.50	—	—	3.31	10.00	—	—	—
FLTCR86031	Front Wheel Simulator Kit, 22.5" x 8.25", 11.25" B.C., 10 Lug, 5 Hand Holes, Stub-Piloted, Stainless	22.50	—	—	3.31	10.00	—	—	—
FLTCR86083	Rear Wheel Simulator Kit with Non-Removable Cap, 22.5" x 8.25", 11.25" B.C., 10 Lug, 2 Hand Holes, Hub-Piloted, Stainless	22.50	—	—	11.38	21.00	252S	—	20306
FLTCR86143	Rear Wheel Simulator Kit with Removable Cap, 22.5" x 8.25", 11.25" B.C., 10 Lug, 2 Hand Holes, Hub-Piloted, Stainless	22.50	—	—	11.38	21.00	252S-33	—	20314
FLTCR86153	Rear Wheel Simulator Kit with Removable Cap, 22.5" x 8.25", 11.25" B.C., 10 Lug, 5 Hand Holes, Hub-Piloted, Stainless	22.50	—	—	11.38	30.00	—	—	—



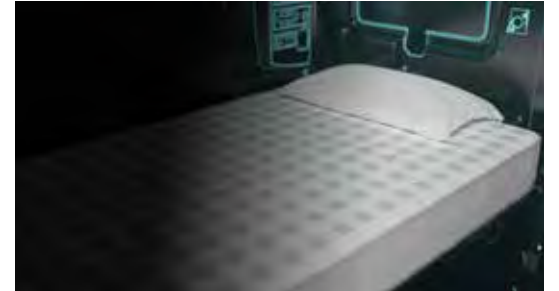

EVERYTHING YOU NEED FOR A COMFORTABLE RIDE.

Our mattresses are of foam construction, handmade in the USA and compression-rolled for easy handling. Order online at RepairLinkShop.com

PARTS FIT TO PERFORM

fleetrite.com



THE MOST COMFORTABLE DECISION YOU'LL EVER MAKE.

Driver comfort and retention are at the very heart of the Pinnacle's design, developed using sophisticated pressure mapping equipment to minimize pressure points, expand adjustability and maximize comfort. For more information on the Pinnacle comfort technologies, suspension innovations and countless adjustable features, please visit www.seatsinc.com.

seatsinc.com

RADIO AND ANTENNAS



STEREOS AND SATELLITE RADIOS

PN	DESCRIPTION	PANA-PACIFIC X-REF
PP107200	Aptiv AM/FM/WB Digital Radio with Front Panel USB/Aux Inputs, Bluetooth, ISO Port	PP107200
PP107201	Aptiv AM/FM/WB Digital Radio with Front Panel USB/Aux Inputs, Bluetooth, Sirius XM Tuner, ISO Port	PP107201
PP107233	ProAudio AM/FM CD Player with Front Panel USB/Aux Inputs and Wireless Remote Control	PP107233
PP107234	ProAudio AM/FM CD Player with Front Panel USB/Aux Inputs and Bluetooth, Microphone Included	PP107234
PP107235	ProAudio AM/FM Digital Radio with Front Panel USB/Aux Inputs and Bluetooth, Sirius XM-Ready	PP107235
PP807155	Aptiv PP107201 Radio with Peiker Bluetooth Microphone and Mirror-Mount Sirius XM Antenna Bundle	PP807155



CB RADIOS AND RELATED PARTS

PN	DESCRIPTION	PANA-PACIFIC X-REF
PP19DXIV	Cobra Compact 40-Channel CB Radio with Illuminated LCD Display, Instant Emergency Channels, P.A.	19DXIV
PPCCBP29LT01	Cobra Classic 40-Channel CB Radio with SWR Meter, Noise Reduction, Adjustable Dynamic Boost, P.A.	CCBP29LT01
PP29LX	Cobra Premium 40-Channel CB Radio with 4-Color LCD Display, Weatherband, Diagnostic Check	29LX
PPCCBP29LTNW	Cobra Professional 40-Channel CB Radio with NightWatch Illuminated Display, Full-Featured, P.A.	CCBP29LTNW
PPHGM73	Cobra 4-Pin Replacement CB Microphone, 9' Cord, Wire Mesh Grille, Durable ABS Shell	HGM73
PPPRO510XL	Uniden Compact 40-Channel CB Radio with Illuminated LCD Display, Instant Channel 9, P.A.	PRO510XL



ANTENNAS AND ACCESSORIES

PN	DESCRIPTION	FLEETRITE X-REF	PANA-PACIFIC X-REF
PPPS302	ProStick CB Antenna Fitting Connector, SO-239	—	PS302
PPPS304	ProStick CB Antenna Shock Spring Base, Stainless Steel with 1" Threaded Stud	—	PS304
PPPS322	ProStick CB Antenna 3-Way Mirror Mount, Aluminum with SO-239 Fitting Connector	—	PS322
PPTSM2	2' CB Replacement Antenna, White, 1,000 Watt Rating, Anti-Breakage Design, Made in the USA	FLTANTW2FR	TSM2
PPTSM2BLK	2' CB Replacement Antenna, Black, 1,000 Watt Rating, Anti-Breakage Design, Made in the USA	FLTANTB2FR	TSM2BLK
PPTSM3	3' CB Replacement Antenna, White, 1,000 Watt Rating, Anti-Breakage Design, Made in the USA	FLTANTW3FR	TSM3
PPTSM3BLK	3' CB Replacement Antenna, Black, 1,000 Watt Rating, Anti-Breakage Design, Made in the USA	FLTANTB3FR	TSM3BLK
PPTSM4	4' CB Replacement Antenna, White, 1,000 Watt Rating, Anti-Breakage Design, Made in the USA	FLTANTW4FR	TSM4
PPTSM4BLACK	4' CB Replacement Antenna, Black, 1,000 Watt Rating, Anti-Breakage Design, Made in the USA	FLTANTB4FR	TSM4BLACK



RADIOS AND ANTENNAS (CONT'D)



POWER INVERTERS

PN	DESCRIPTION	PANA-PACIFIC X-REF
PPCM1512	Tundra Complete 1,500 Watt Power Inverter Installation Kit, 12' Cables, Efficient and Safe	CM1512
PPCM2012	Tundra Complete 2,000 Watt Power Inverter Installation Kit, 12' Cables, Efficient and Safe	CM2012
PPCPI1500W	Cobra 1,500 Watt Modified Sine Wave Power Inverter, 4 AC Outlets, Includes 4' Power Cables	CPI1500W
PPCPI2500W	Cobra 2,500 Watt Modified Sine Wave Power Inverter, 4 AC Outlets, Includes 4' Power Cables	CPI2500W
PPM1500	Tundra 1,500 Watt High-Efficient Modified Sine Wave Power Inverter, 2 AC Outputs, Wired Remote	M1500
PPM2000	Tundra 2,000 Watt High-Efficient Modified Sine Wave Power Inverter, 2 AC Outputs, Wired Remote	M2000



MOBILE ACCESSORIES

PN	DESCRIPTION	PANA-PACIFIC X-REF
PPCRX50	Dometic 1.6 Cu. Ft. Mobile Refrigerator, Removable Freezer Shelf, 12/24V DC Operation	CRX-50
PPMW700	Tundra Mobile Microwave, 0.7 Cu. Ft., 700 Watt, (17.9" L x 10.4" H x 14.0" W), UL Approved, 120V	MW700
PPVF51	Vitrifigo 1.8 Cu. Ft. Mobile Refrigerator/Freezer, Voltage Protection, 12V DC Operation	VF51



GLASS



DOOR WINDOWS

PN	DESCRIPTION	APPLICATION
3554253C2	Window, Rear, Unprimed with Tabs	4100, 4200, 4300, 4400, 7300, 7400, 7500, 7600, 7700, 8500, 8600, APRO, CXT, EVMV, HVHD, HVMD, HX, LS, LT, MV, MXT, NC2, PRO, PROL, PROP, RH, RXT, TG01, TR01
498726C3	Window with Shield, Tinted, RH	5870, 9600, 9700
498725C3	Window with Shield, Tinted, LH	5870, 9600, 9700
425509002	Window, Storm, 5/8" Laminated, Top and Bottom	—
421742002	Window, Storm, 5/8" Laminated, Driver's Side Entrance	—
6020310C1	Window, Door LH	CF50, CF60, JCF5, JCF6
6020311C1	Window, Door RH	CF50, CF60, JCF5, JCF6
3586958C2	Window, Rear Side	CF50, CF60, JCF5, JCF6
3716842C2	Window, Rear, Tinted	660
3866663C3	Window Assembly, Door LH	660, 680
3866664C3	Window Assembly Door RH	660, 680
FLTDB10038PK1	Window, Back, Tinted	Universal Fit
FLTDD10036PK1	Window, Passenger Door	Universal Fit
FLTDD10037PK1	Window, Driver Door	Universal Fit

DOOR PARTS



INTERNATIONAL

PN	DESCRIPTION	APPLICATION	TRP X-REF	DORMAN X-REF	AUTOMANN X-REF
4053965C93	Handle, Door Inside, Chrome, LH	CACB, EVMV, HVHD, HVMD, HX, LS, LT, MV, RH	—	—	—
4106632C91	Handle, Door Inside	7600, APRO, HVHD, HVMD, MV, NC2, PRO, PROL, PROP, TG01	—	—	—
1665129C1	Handle, Door Inside, Black	2500, 2600, 3000, 4700, 4800, 4900, 8100, 8500	—	—	—
3518516C91	Handle, Door Inside, Remote LH	5000, 5500, 5600, 5900, 9100, 9200, 9400, 9800, 9900	DRH051000L	761-5106	HLK2073
3518517C91	Handle, Door Inside, Remote RH	5000, 5500, 5600, 5900, 9100, 9200, 9400, 9800, 9900	DRH051000R	761-5107	HLK2074
2507608C1	Handle, Door Inside, RH	4100, 4200, 4300, 4400, 7300, 7400, 7500, 7600, CXT, MXT, RXT	—	—	—
6127257C91	Handle, Door Inside, Release LH	HX	—	—	—
6127255C3	Handle, Door Inside	HX	—	—	—
2507601C1	Handle, Door Inside, LH	4100, 4200, 4300, 4400, 7300, 7400, 7500, 7600, CXT, MXT, RXT	—	—	—
6127256C3	Handle, Door Inside	HX	—	—	—
6127258C91	Handle, Door Inside, Release RH	HX	—	—	—



ALL-MAKES

PN	DESCRIPTION	APPLICATION
6020318C1	Handle, Door Inside, LH	CF50, CF60, JCF5, JCF6
6020319C1	Handle, Door Inside, RH	CF50, CF60, JCF5, JCF6
6020218C1	Handle, Door Inside, Pull	CF50, CF60, JCF5, JCF6
3863439C93	Handle, Door Inside, LH	660, 680
3866660C93	Handle, Door Inside, Assembly Release, RH	660, 680

SEATS AND SEAT COVERS (CONT'D)



SEATS INC. MEDIUM-DUTY SEATS

PN	DESCRIPTION	MATERIAL	COLOR	FREIGHTLINER M2 X-REF	PETERBILT X-REF	AUTOCAR® WX/VOLVO WX X-REF	GMC X-REF	FORD X-REF	MACK X-REF
S189019KA21	Heritage® LO, Low Profile Suspension, High Back, 20" Cushion, 15 Degree Recline, Adjustable Lumbar, Isolator	SyncPLUS Cloth™	Black	168655PS (Required)	—	—	—	—	—
S189019KA25	Heritage® LO, Low Profile Suspension, High Back, 20" Cushion, 15 Degree, Adjustable Lumbar, Isolator	SyncPLUS Cloth™	Grey	—	—	—	—	—	—
S185069FN631	3R Pro Seat	Tuff Cloth	Black	—	Peterbilt 320 No adapter needed	181058PS required when replacing National or DuraForm/SEARS. No adapter replacing Bostrom	Topkick 178111PS (1999–2003), Topkick 179119PS (2004–2010)	F650–F750 178093PS	Mack MR 180229PS, Mack LE 178094PS
S185069FN635	3R Pro Seat	Tuff Cloth	Grey	—	Peterbilt 320 No adapter needed	181058PS required when replacing National or DuraForm/SEARS. No adapter replacing Bostrom	Topkick 178111PS (1999–2003), Topkick 179119PS (2004–2010)	F650–F750 178093PS	Mack MR 180229PS, Mack LE 178094PS
S185069VN601	3R Pro Seat	Vinyl	Black	—	Peterbilt 320 No adapter needed	181058PS required when replacing National or DuraForm/SEARS. No adapter replacing Bostrom	Topkick 178111PS (1999–2003), Topkick 179119PS (2004–2010)	F650–F750 178093PS	Mack MR 180229PS, Mack LE 178094PS
S185069VN605	3R Pro Seat	Vinyl	Charcoal/Grey	—	Peterbilt 320 No adapter needed	181058PS required when replacing National or DuraForm/SEARS. No adapter replacing Bostrom	Topkick 178111PS (1999–2003), Topkick 179119PS (2004–2010)	F650–F750 178093PS	Mack MR 180229PS, Mack LE 178094PS

SEATS INC. SCHOOL BUS SEATS

PN	DESCRIPTION	MATERIAL	COLOR	APPLICATION
S176566ZN45	Magnum 100, Air Suspension, Knee–Action Suspension, Right Side Adjustment, 6" Double Locking Tracks, 5" Riser, No Arms	Prevail	Black	Blue Bird and Carpenter
S176567ZN45	Magnum 100, Air Suspension, Knee–Action Suspension, Right Side Adjustment, 6" Double Locking Tracks, 3.83" Riser, No Arms	Prevail	Black	IC Corp (before 2004) and Thomas Built (not C2)
S176568ZN45	Magnum 200, Mechanical Suspension, Knee–Action Suspension, Right Side Adjustment, 6" Double Locking Tracks, 5" Riser, No Arms	Prevail	Black	Blue Bird and Carpenter
S176569ZN45	Magnum 200, Mechanical Suspension, Knee–Action Suspension, Right Side Adjustment, 6" Double Locking Tracks, 3.83" Riser, No Arms	Prevail	Black	IC Corp (before 2004) and Thomas Built (not C2)
S180127ZN45	Magnum 100, Air Suspension, Knee–Action Suspension, Right Side Adjustment, 6" Double Locking Tracks, 3.83" Riser, No Arms	Prevail	Black	IC Corp 2004 to 8/11/13
S180128ZN45	Magnum 200, Mechanical Suspension, Knee–Action Suspension, Right Side Adjustment, 6" Double Locking Tracks, 3.83" Riser, No Arms	Prevail	Black	IC Corp 2004 to 8/11/13

BOSTROM SEATING

PN	DESCRIPTION	SEAT MODEL	MATERIAL	COLOR
B1247000544	HiPro Suspension, Mid Back	Baja	Vinyl	Black
B1247001544	HiPro Suspension, High Back	Baja	Vinyl	Black
B2339131550	HiPro Suspension, High Back	T-Series	Mordura Cloth	Black
B2339131552	HiPro Suspension, High Back	T-Series	Mordura Cloth	Grey
B2339131554	HiPro Suspension, High Back	T-Series	Mordura Cloth	Blue
B2356001544	HiPro Suspension, High Back	Patriot	Vinyl	Black
B2356001550	HiPro Suspension, High Back	Patriot	Mordura Cloth	Black
B5100001K86	LoPro Suspension, High Back	Wide Ride + Serta	Titan Cloth	Grey
B5100001L84	LoPro Suspension, High Back	Wide Ride + Serta	Titan Cloth	Black/Grey
B5100001900	HiPro Suspension, Mid Back	Wide Ride + Serta	Ultra–Leather	Black
B5300001900	HiPro Suspension, High Back	Wide Ride + Serta	Ultra–Leather	Black
B5A09071900	LoPro Suspension, High Back	Wide Ride Core	Ultra–Leather	Grey
B5A09071902	LoPro Suspension, High Back	Wide Ride Core	Ultra–Leather	Grey
B5A09071L77	LoPro Suspension, High Back	Wide Ride Core	Ultra–Leather	Black/Grey
B5B09071900	HiPro Suspension, High Back	Wide Ride Core	Ultra–Leather	Black
B9220011900	HiPro Suspension, High Back	ProRide	Ultra–Leather	Black
B9220011K85	HiPro Suspension, High Back	ProRide	Titan Cloth	Black
B9220011L84	HiPro Suspension, High Back	ProRide	Titan Cloth	Black/Grey



Other colors and materials are available, please contact your dealer.

SEATS AND SEAT COVERS (CONT'D)



NATIONAL SEATING

PN	DESCRIPTION	SEAT MODEL	MATERIAL	COLOR
NS40049355	HiPro Suspension, High Back	Admiral	Leather	Black
NS40049366	HiPro Suspension, High Back	Admiral	Mordura Cloth	Black/Charcoal
NS40050041	HiPro Suspension, High Back	Admiral	Ultra-Leather	Grey/Grey
NS40050046	HiPro Suspension, High Back	Admiral	Ultra-Leather	Grey/Black
NS40050065	HiPro Suspension, High Back	Admiral	Mordura Cloth	Black
NS50764361	HiPro Suspension, High Back	Captain	Mordura Cloth	Grey
NS50764365	HiPro Suspension, High Back	Captain	Mordura Cloth	Black
NS5107936C	HiPro Suspension, High Back	Captain Plus	Mordura Cloth	Grey
NS5107936G	HiPro Suspension, High Back	Captain Plus	Mordura Cloth	Black/Grey
NS51100045A	HiPro Suspension, High Back	Corsair®	Ultra-Leather	Black
NS51100046A	HiPro Suspension, High Back	Corsair®	Ultra-Leather	Black/Grey
NS51100065A	HiPro Suspension, High Back	Corsair®	Mordura Cloth	Black/Charcoal
NS51110305	HiPro Suspension, High Back	Ensign	Vinyl	Black
NS5111035	HiPro Suspension, High Back	Ensign	Forever Cloth	Black
NS51112396	HiPro Suspension, High Back	Ensign	Vinyl/Mordura Cloth	Black/Grey

Other colors and materials are available, please contact your dealer.

NATIONAL SEATING REFUSE SEATS

PN	DESCRIPTION	MATERIAL	COLOR
NS40233075	Refuse Truck Seat, Mid Back, Water and Stain Resistant	Cloth	Black
NS40233078	Refuse Truck Seat, Mid Back, Water and Stain Resistant	Cloth	Grey

NATIONAL SEATING SCHOOL BUS SEATS

PN	DESCRIPTION	MATERIAL	COLOR
NS51118065	Routemaster 350 Seat, No Arm Rest	Mordura	Black
NS51118066	Routemaster 350 Seat, No Arm Rest	Mordura	Grey
NS51118266	Routemaster 350 Seat, Right Hand Arm Rest	Mordura	Charcoal

NATIONAL SEATING MEDIUM-DUTY SEATS

PN	DESCRIPTION	MATERIAL	COLOR
NS71124001	Captain Lo 97 Air Suspension, High Back, No Arm Rests	Vinyl	Grey
NS71124301	Captain Lo 97 Air Suspension, High Back, Dual Arm Rests	Vinyl	Grey
NS71124366	Captain Lo 97 Air Suspension, High Back, Dual Arm Rests	Mordura	Black/Grey

SEAT COVERS

RIG TOUGH PN	DESCRIPTION	MATERIAL	COLOR	SEATS INC. X-REF
NS5301101	Universal Fit, Cover	HD 900 Denier Polyester-Canvas, Stain Resistant	Black	181704XN1161
NS5301102	Universal Fit, Cover	HD 900 Denier Polyester-Canvas, Stain Resistant	Black/Grey	181704XN1165

MATTRESSES AND MATTRESS COVERS



INNERSPRING MATTRESSES

PN	DESCRIPTION	SIZE
INTERNATIONAL		
ESBRS3480	Mattress, Innerspring Roll-up	34" x 80"
1652798C1	Pad, Mattress, Sleeper, Innerspring	39" x 80"
1697136C2	Pad, Mattress, Innerspring	32" x 80"
1676875C2	Pad, Mattress, Sleeper, Innerspring	36" x 80"
2010343C3	Pad, Mattress, Sleeper, Innerspring	36" x 79"
FLEETRITE		
FLT42808S	Mattress, Innerspring	42" x 80"
FLT39806S	Mattress, Innerspring	39" x 80"
FLT39806S	Mattress, Innerspring	39" x 80"
FLT36807S	Mattress, Innerspring	36" x 80"
FLT36807S	Mattress, Innerspring	36" x 80"
FLT36796S	Mattress, Innerspring	36" x 79"
FLT36796S	Mattress, Innerspring	36" x 79"



Mattresses fit multiple applications. Other sizes and comfort levels are available.

SHEETS

PN	DESCRIPTION	SIZE
INTERNATIONAL		
2506911C1	Set, Fitted Sheet and Pillow Case	36" x 80"
2506914C1	Set, Fitted Sheet and Pillow Case	32" x 80"
2506915C1	Set, Fitted Sheet and Pillow Case	38" x 80"
2506916C1	Set, Fitted Sheet and Pillow Case	42" x 80"
2506917C1	Set, Fitted Sheet and Pillow Case	36" x 75"
FLEETRITE		
FLT4280SS	White, Adjustable Sheet Set	Minimum 35" x 75", Maximum 42" x 80"



Mattresses fit multiple applications. Other sizes and comfort levels are available.

FOAM MATTRESSES

INTERNATIONAL	DESCRIPTION	SIZE
JB34808F	Premium Mattress, Foam	34" x 80"
2513885C1	Mattress, Sleeper	42" x 80"
2513887C1	Pad, Mattress, Foam	33" x 84"
2513884C1	Pad, Mattress, Sleeper	36" x 79"
2513886C1	Mattress, Foam	30" x 80"
2513888C1	Pad, Mattress, Sleeper Foam	42" x 80"

Mattresses fit multiple applications. Other sizes and comfort levels are available.

FOAM AND FOAM WITH POLY AND NYLON MATTRESSES

FLEETRITE	DESCRIPTION	SIZE
FLT388065F	Mattress, Sleeper, Foam	38" x 80"
FLT388055F	Mattress, Sleeper, Foam	38" x 80"
FLT428065F	Mattress, Sleeper, Foam	42" x 80"
FLT357955F	Mattress, Sleeper, Foam	35" x 79"
FLT357965F	Mattress, Sleeper, Foam	35" x 79"
FLT287940F	Mattress, Sleeper, Foam	28" x 79"
FLT428055F	Mattress, Sleeper, Foam	42" x 80"
FLT287955F	Mattress, Sleeper, Foam	28" x 79"
FLT388040F	Mattress, Sleeper, Foam	38" x 80"



Mattresses fit multiple applications. Other sizes and comfort levels are available.

PILLOWS

PN	DESCRIPTION	SIZE
INTERNATIONAL		
2506910C1	Pad Pillow, Polyester Filled	22 oz.
FLEETRITE		
FLT2520PL	Pillow	26" X 20"



Fleetrite® Premium Mattresses – Quality is Key

Smooth, Quilted Surface

- Catch a good night's rest with the help of a Fleetrite® premium mattress smooth quilted surface, providing a soft and supportive feel. Choose your mattress from the foam or innerspring styles.

Easy to Handle

- New Fleetrite mattresses are easy to handle. Our mattresses are made of compressed foam for ease of handling, transporting and carrying into your truck.

Waterproof and Machine Washable

- Fleetrite mattress protectors are waterproof, machine washable and completely encase the mattress. The encasement protects against bed bugs, dust mites and other allergens.

Complete Your Space

- Sheet sets and pillows complete your space for a comfortable rest.

fleetrite.com

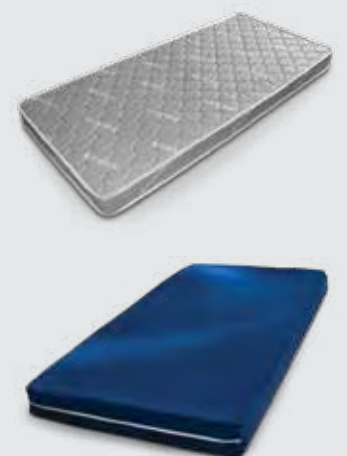



UP TO 85% LESS ENGINE WEAR.

Our heavy-duty engine oil increases protection and maximizes fuel economy.

Order online at RepairLinkShop.com

PARTS FIT TO PERFORM

fleetrite.com



KEEPING YOUR ENGINES COOL.

Works in all heavy-duty diesel, gasoline and natural gas engine cooling systems.

Order online at RepairLinkShop.com

PARTS FIT TO PERFORM

fleetrite.com



OILS AND GREASES



OIL

SHELL/SHELL CANADA PN	DESCRIPTION	SAE GRADE	PACKAGE SIZE	FLEETRITE X-REF	CHEVRON/CHEVRON CANADA X-REF	PETRO CHOICE X-REF
ZSH500010011B/ SH500010011	ROTELLA T4 TRIPRO 10W-30 CK4	10W-30	Bulk	FLTLP10W30CK4B	ZJB257000B/ ZJB257000990	UL004643
ZSH550045137D/ SH550045137	ROTELLA T4 TRIPRO 10W-30 CK4	10W-30	Drum	FLTLP10W30CK4D	ZJB257000D	UL004644
ZSH550045136P/ SH550045136	ROTELLA T4 TRIPRO 10W-30 CK4	10W-30	Pail	FLTLP10W30CK4P	ZJB257000P	UL004646
ZSH550045144G/ SH550045139	ROTELLA T4 TRIPRO 10W-30 CK4	10W-30	Gallon	FLTLP10W30CK4G	ZJB257000GA/ ZJB257000464	UL008094
ZSH500010047B/ SH500010121	ROTELLA T5 10W-30 CK4	10W-30	Bulk	—	—	—
ZSH550045131D/ SH550045131	ROTELLA T5 10W-30 CK4	10W-30	Drum	—	—	—
ZSH550045130G/ SH550045018	ROTELLA T5 10W-30 CK4	10W-30	Gallon	—	—	—
ZSH500010048B/ SH500010048	ROTELLA T4 TRIPROT 15W-40 CK4	15W-40	Bulk	FLTL15W40CK4B	ZJB222290B/ ZJB222290990	UL004633
ZSH550045148D/ SH550045148	ROTELLA T4 TRIPROT 15W-40 CK4	15W-40	Drum	FLTL15W40CK4D	ZJB222290D/ ZJB222290981	UL004634
ZSH550045128P/ SH550045128	ROTELLA T4 TRIPRO 15W-40 CK4	15W-40	Pail	FLTL15W40CK4P	ZJB222290P/ ZJB222290448	UL004636
ZSH550045126G/ SH550045135	ROTELLA T4 TRIPRO 15W-40 CK4	15W-40	Gallon	FLTL15W40CK4G	ZJB222290GA/ ZJB222290464	UL002052
ZSH500010132B/ SH500010132	ROTELLA T5 15W-40 CK4	15W-40	Bulk	—	—	—
ZSH550067157P	ROTELLA T5 15W-40 CK4	15W-40	Pail	—	—	—
ZSH550045348G/ SH550045349	ROTELLA T5 15W-40 CK4	15W-40	Gallon	—	—	—



TRANSMISSION FLUID

PN	DESCRIPTION	PACKAGE SIZE	SHELL X-REF	FLEETRITE X-REF	CHEVRON X-REF
FLTATF295GKK	Fleetrite Synthetic Automatic Transmission Fluid	Jug	SHATF295	—	—
FLTATF295D	Fleetrite 295 Automatic Transmission Fluid	Drum	—	—	ZJB223073D
FLTATF295P	Fleetrite 295 Automatic Transmission Fluid	5 Gallon	ZSH550062007G	—	—
FLTLATFMD3QKK	Fleetrite Automatic Transmission Fluid MD3 Mercon/Dexro	Quart	—	—	ZJB226502Q
FLTMTF386D	Fleetrite 386 Manual Transmission Fluid	Drum	—	—	—
FLTMTF386G	Fleetrite 386 Manual Transmission Fluid	Gallon	—	—	—
FLTMTF386P	Fleetrite 386 Manual Transmission Fluid	5 Gallon	—	—	—



GEAR OIL

PN	DESCRIPTION	PACKAGE SIZE	SHELL X-REF	CHEVRON X-REF	PETRO CHOICE X-REF
991879C1	Gear Lubricant 75W-90	5 Gallon	ZSH550026915P	—	UL004918
991884C2	Oil SAE 50 Synthetic Gear Lube	Gallon	—	—	—
FLTL80W90P	Fleetrite 80W-90	5 Gallon	ZSH550043587P	—	—
FLTL85W140P	Fleetrite 85W-140	5 Gallon	ZSH550043591P	ZJB223021773	—
FLTW80W140D	Fleetrite 80W-140	Drum	—	—	—
FLTW80W140P	Fleetrite 80W-140	5 Gallon	—	—	—
FLTXFE75W90D	Fleetrite Axle 75W-90	Drum	ZSH550026918D	—	—
FLTXFE75W90P	Fleetrite 75W-90	5 Gallon	—	—	UL004918



Are You Still Using a 15W-40?

International began factory-filling trucks with Shell ROTELLA® 10W-30 in 1998. One of our 10W-30 products, Shell ROTELLA T5 10W-30, helps you save up to 2% in fuel economy compared to a conventional 15W-40. It delivers up to 44% better wear protection based on API CK-4 wear test results. Get the most out of your engine by using Shell ROTELLA T5 10W-30.

shell.us/transport



OILS AND GREASES (CONT'D)



GREASE

PN	DESCRIPTION	PACKAGE SIZE	SHELL X-REF	FLEETRITE X-REF	CHEVRON X-REF
ZSH550027558T	Gadus S3 V220C 10 4 Kilograms	Tube	—	—	—
ZSH550027631T	Gadus S2 V220 2 10 Kilograms	Tube	—	—	—
ZSH550026854K	Gadus S3 V220C 2 Kilograms	Keg	—	—	—
ZSH550027645T	Gadus S2 V460A 2 10 Kilograms	Tube	—	—	—

COOLANTS



COOLANT

PN	DESCRIPTION	PACKAGE SIZE	SHELL/SHELL CANADA X-REF	CHEVRON X-REF	FLEETGUARD X-REF	
RED	FLTRELCCG	Red Extended Life Concentrate	Gallon	ZSH9404106021G/ SH550057732	ZJB227808GA	CC36166USJ
	FLTRELCS050G	Red Extended Life 50/50	Gallon	ZSH9404206021G/ SH550057733	ZJB227811BO	CC36161USJ
	FLTRELCCD	Red Extended Life Concentrate	Drum	ZSH550022521D/ SH550022521	ZJB227808D	CC36166USD
	FLTRELCS050D	Red Extended Life 50/50	Drum	ZSH550022522D/ SH550022522	ZJB227811D	CC36161USD
	FLTUELCCG	Nitrite Free ELC Concentrate	Gallon	ZSH550041812G/ SH550057738	—	CC36073
	FLTUELCS050G	Nitrite Free ELC 50/50	Gallon	ZSH550041810G/ SH550057739	ZJB227077GA	CC36077
	FLTUELCCD	Nitrite Free ELC Concentrate	Drum	ZSH550041813D/ SH550041813	—	CC36072
	FLTUELCS050D	Nitrite Free ELC 50/50	Drum	ZSH550041811D/ SH550041811	ZJB227077D	CC36076
PINK	FLTPSCACG	Precharged SCA Concentrate	Gallon	—	—	—
	FLTPSCA5050G	Precharged SCA 50/50	Gallon	—	—	CC8974
	FLTPSCACD	Precharged SCA Concentrate	Drum	—	—	CC8967
	FLTPSCA5050D	Precharged SCA 50/50	Drum	—	—	CC8972
GREEN	FLTGCONVCG	Green Conventional Concentrate	Gallon	ZSH9401006021G	ZJB226110GA	—
	FLTGCONV5050G	Green Conventional 50/50	Gallon	ZSH9406706021G	ZJB226821GA	—
	FLTGCONVCD	Green Conventional Concentrate	Drum	ZSH9401000055D	ZJB226110D	—
	FLTGCONV5050D	Green Conventional 50/50	Drum	ZSH550022525D	—	—
YELLOW	—	ShellZone MV AF Concentrate	Gallon	ZSH5066315G	—	—
	—	ShellZone MV AF Concentrate	Drum	ZSH550022293D	—	—
	—	ShellZone MV AF 50/50	Gallon	ZSH5066325G	—	—
	—	ShellZone MV AF 50/50	Drum	ZSH550022294D	—	—



DEF



FLEETRITE DEF

PN	DESCRIPTION	PACKAGE SIZE	TRP X-REF	PEAK X-REF
FLTFB	Fleetrite DEF	Bulk	CBBULK5K	—
FLTFP	Fleetrite DEF	Jug	CB0025	DEF002
FLTFQ	Fleetrite DEF	Drum	CB0550	—



Fleetrite® Engine Oil Has Improved Fuel Economy

Fleetrite's engine oil formulation contains many special features, including unique friction modifiers and new FA-4 viscosity to deliver improved fuel economy along with increasing engine life and protect against corrosion and wear.

fleetrite.com





LOWER VISCOSITY OILS ARE BECOMING THE NEW INDUSTRY STANDARD

Navistar has been factory-filling with a 10W-30 since 1998,
and the demand for 10W-30 continues to grow.



It's easy to see why.
Lower viscosity oils offer:

- Better protection against wear, deposits and oil breakdown
- Improved performance, even in extreme temperatures and conditions
- Reduced fuel costs and CO2 emissions (achieve up to 2% in fuel economy savings with Shell Rotella® T5 10W-30 Synthetic Blend)

Keep your trucks on the move.



SHELL ROTELLA® T5
10W-30 Synthetic Blend



SHELL ROTELLA® T4
Triple Protection® 10W-30

SHELL
LUBRICANT SOLUTIONS

Learn more at
www.shell.us/transport

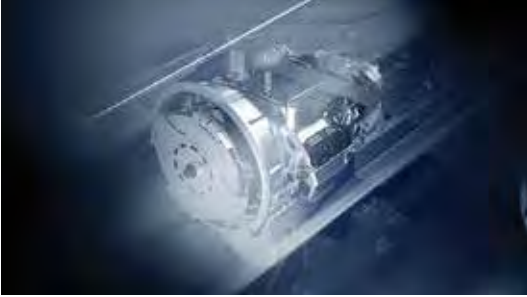

RENEWED™

SECURITY ON THE ROAD.

RENEWED™ drivetrain components cost significantly less than new and offer greater reliability with re-engineered knowledge powering each component.

RE-ENGINEER YOUR UPTIME

fleetrte.com/renewed



EATON

ADVANTAGE SERIES.

Now with a 3-year unlimited mile warranty. Best over-the-counter clutch warranty in the industry. The strap drive intermediate plate is leading technology in the market that no one else offers.

eaton.com



HEAVY-DUTY CLUTCHES



HEAVY-DUTY CLUTCHES

PN	DESCRIPTION	APPLICATION	EATON X-REF	FLEETRITE X-REF	TRP X-REF
15.5" HEAVY-DUTY SELF ADJUST					
C30970182	15.5" Clutch Size, 2.00"-10 Input Shaft Size, Torque Capacity 1700 Ft Lbs.	Advantage® Self-Adjust	309701-82	FLTC10960182	—
C30970120	15.5" Clutch Size, 2.00"-10 Input Shaft Size, Torque Capacity 1860 Ft Lbs.	Advantage® Self-Adjust	309701-20	FLTC10960120	—
C30970124	15.5" Clutch Size, 2.00"-10 Input Shaft Size, Torque Capacity 1750 Ft Lbs.	Advantage® Self-Adjust	309701-24	—	—
C30970134	15.5" Clutch Size, 2.00"-10 Input Shaft Size, Torque Capacity 1750 Ft Lbs.	Advantage® Self-Adjust	309701-34	—	—
C30970125	15.5" Clutch Size, 2.00"-10 Input Shaft Size, Torque Capacity 2050 Ft Lbs.	Advantage® Self-Adjust	309701-25	FLTC10960125	—
15.5" HEAVY-DUTY MANUAL ADJUST					
C30892582	15.5" Clutch Size, 2.00"-10 Input Shaft Size, Torque Capacity 1700 Ft Lbs.	Easy Pedal Advantage® Manual Adjust	308925-82	FLTC10892582	CL108825-82
C30892525	15.5" Clutch Size, 2.00"-10 Input Shaft Size, Torque Capacity 2050 Ft Lbs.	Easy Pedal Advantage® Manual Adjust	308925-25	FLTC10892525	—
C30892520	15.5" Clutch Size, 2.00"-10 Input Shaft Size, Torque Capacity 1860 Ft Lbs.	Easy Pedal Advantage® Manual Adjust	308925-20	—	—
C10892582AM	15.5" Clutch Size, 2.00"-10 Input Shaft Size, Torque Capacity 1700 Ft Lbs.	EverTough® Manual Adjust	108925-82AM	—	—
14" HEAVY-DUTY MANUAL ADJUST					
C10806359	14" Clutch Size, 1.75"-10-Spline, Torque Capacity 1400 Ft Lbs.	Easy Pedal Advantage® Manual Adjust	108063-59	—	—
C1083346	14" Clutch Size 2.00"-10 Input Shaft Size, Torque Capacity 950 Ft Lbs.	Easy Pedal Advantage® Manual Adjust	108334-6	—	—
C10803461B	14" Clutch Size, 2.00"-10 Input Shaft Size, Torque Capacity 1000 Ft Lbs.	Easy Pedal Advantage® Manual Adjust	108034-61B	—	—
C10803482B	14" Clutch Size, 2.00"-10 Input Shaft Size, Torque Capacity 1150 Ft Lbs.	Easy Pedal Advantage® Manual Adjust	108034-82B	—	—
C10805059B	14" Clutch Size, 2.00"-10 Input Shaft Size, Torque Capacity 1400 Ft Lbs.	Easy Pedal Advantage® Manual Adjust	108050-59B	FLTC10805059	CL108150-59
HEAVY-DUTY AUTOMATED					
C12200235A	15-1/2" x 2" ECA-Electric Clutch Actuation with Low Capacity Inertia Brake (LCIB), Two Disc, 7 Spring, 1850 Ft Lbs. Torque, 14-Spline	UltraShift™ Plus and Fuller Advantage®	122002-35A	—	—
C12200235EX	15-1/2" x 2" ECA-Electric Clutch Actuation, Two Disc, 7 Spring, 1850 Ft Lbs. Torque, 14-Spline	UltraShift™ Plus and Fuller Advantage®	122002-35EX	—	—
C1210001	15-1/2" x 2" DM Clutch, Two Disc, 1750 Ft Lbs. Torque, Ceramic Facing, 6 Pad, 7 Spring, 10-Spline	UltraShift™	121000-1	—	—
C1044611	430mm Push Wear-Through, 1850 Ft Lbs. Torque, 5 Damper Spring, Organic Facing, Pre-Damper	Volvo I-Shift™	104461-1	—	—
C1044611	430mm Push Wear-Through, 1850 Ft Lbs. Torque, 5 Damper Spring, Organic Facing, Pre-Damper	Mack mDRIVE™	104461-1	—	—
CK4489CL	430mm Push, Self-Adjusting Diaphragm Spring, Organic Facing, Pre-Damper	Detroit® DT-12®	K-4489CL	—	—
CK4488CL	430mm Push, Diaphragm Spring, Organic Facing, Pre-Damper, 3.7" ISO	Eaton Endurant™, Cummins X15™, PACCAR MX through 2020, International A26	K-4488CL	—	—
CK4494CL	430mm Push, Diaphragm Spring, Organic Facing, Pre-Damper, 3.4" SAE	Eaton Endurant™, Cummins X12™, X15™	K-4494CL	—	—



HEAVY-DUTY ACTUATORS

PN	DESCRIPTION
CK4515CL	Clutch Actuator for Detroit® DT12®
CK4516CL	Clutch Actuator for Volvo I-Shift™/Mack mDrive™

MEDIUM-DUTY CLUTCHES



MEDIUM-DUTY CLUTCHES

PN	DESCRIPTION	APPLICATION	EATON X-REF	FLEETRITE X-REF	TRP X-REF
SHORT STROKE (.410" TO .470" BEARING TRAVEL)					
C1094045	1.75"-10-Spline, Torque Capacity 620 Ft Lbs.	Solo® Self-Adjust	109404-5	—	—
C10950310	1.75"-10-Spline, Torque Capacity 860 Ft Lbs.	Solo® Self-Adjust	109503-10	—	—
STANDARD STROKE (.500" TO .560" BEARING TRAVEL)					
C10723710	STD Stroke 0.500" to 0.560" Bearing Travel, 1.75"-10-Spline, Torque Capacity 860 Ft Lbs.	Eaton Manual Adjust	107237-10	FLTC10723710w	CL107337-10
C1076835	STD Stroke 0.500" to 0.560" Bearing Travel, 1.75"-10-Spline, Torque Capacity 620 Ft Lbs.	Eaton Manual Adjust	107683-5	FLTC1076835	—
C10950010	STD Stroke 0.500" to 0.560" Bearing Travel, 1.75"-10-Spline, Torque Capacity 860 Ft Lbs.	Solo® Self-Adjust	109500-10	FLTC10723710	CL107337-10
C10950022	0.500" to 0.560" Bearing Travel, 1.75"-10-Spline, Torque Capacity 860 Ft Lbs.	Solo® Self-Adjust	109500-22	—	—
C10734212	0.500" to 0.560" Bearing Travel, 2.0"-10-Spline, Torque Capacity 860 Ft Lbs.	Eaton Manual Adjust	107342-12	FLTC10734212	CL107442-12
C1094005	1.75"-10 Input Shaft Size, Torque Capacity 620 Ft Lbs.	Solo® Self-Adjust	109400-5	FLTC1076835	—
DIAPHRAGM STYLE					
C1042001	Clutch, Diaphragm Spring, Adjustment Free, 1.75"-10-Spline, Torque Capacity 860 Ft Lbs.	—	104200-1	—	—
C1041002	Clutch, Diaphragm Spring, Adjustment Free, 1.75"-10-Spline, Torque Capacity 660 Ft Lbs.	—	104100-2	—	—



CLUTCH ACCESSORIES AND RELATED PARTS



CLUTCH BRAKES

PN	DESCRIPTION	EATON X-REF	FLEETRITE X-REF	TRP X-REF
C127200	Kwik Konnect®, 2" Shaft Size, 2-Piece	1272-00	—	CB127200
C127740	Torque Limiting, 1-3/4" Shaft Size, 1-Piece	1277-40	—	CP127740
C127760	Torque Limiting, 2" Shaft Size, 1-Piece	1277-60	—	CB127760
BK313	2" Shaft Size, 2-Piece, Hinged	—	ZZBK313	CB313SP



CLUTCH RELATED PARTS

PN	DESCRIPTION	EATON X-REF	FLEETRITE X-REF	TRP X-REF
T105C137	Clutch Release Yoke	105C137	—	CF105C137
FUL12815	Clutch Release Shaft Bushing	12815	—	—
FUL4305294	Shift Cover Gasket	4305294	—	—
CLT008P	Grease Tube, Clutch Supply Line, 8"	T008P	—	CPCLT008P
CLT012	Grease Tube, Clutch Supply Line, 12"	T012	—	—
FULK2468	Clutch Installation Kit, RT Series	2468	FLT2468	CK1771
FLK3600	Clutch Installation Kit, FR Series	FLK3600	FLT3600	CK1910
FLK4145	Clutch Installation Kit, UltraShift® Plus Series	FLK4145	—	—



PILOT BEARINGS

PN	DESCRIPTION	FLEETRITE X-REF
2004507C1	Pilot Bearing, Transmission Input Shaft	FLT63062RS2
3004456C1	Pilot Bearing, Transmission Input Shaft	—
6306-2ZNRJ	Pilot Bearing, Transmission Input Shaft with Snap Ring	—
6306LLUAI3/2E	Pilot Bearing, Transmission Input Shaft	FLT63062RS2



TRANSMISSIONS AND TRANSMISSION PARTS



REMAN ALLISON - U.S. ONLY

PN	DESCRIPTION	ALLISON X-REF
RAT29514624	Transmission, Auto, Allison	29514624
RAT29544719	Transmission, RENEWED™, 2000 Series Genuine	29544719
RAT29550041	Transmission, RENEWED™, 2000 Series Genuine	29550041
RAT29544743	Transmission, RENEWED™, 2000 Series Genuine	29544743
RAT29544718	Transmission, RENEWED™, 2000 Series Genuine	29544718
RAT29514623	Transmission, Auto, Allison	29514623
RAT29549630	Transmission, RENEWED™, B400R Series Genuine	29549630



REMAN TRANSMISSION HEAVY

PN	DESCRIPTION	EATON/FULLER X-REF	WELLER X-REF	MASCOT X-REF
RHTFRO16210CP (U.S.), RCFRO16210CP (CAN)	Transmission, Manual, Eaton/Fuller FLEX Reman, STD Shift Bar Housing	—	—	—
RHTFROF16210CP (U.S.), RCFROF16210CP (CAN)	RENEWED™ Transmission Manual Eaton/Fuller 10-Speed Overdrive Shift Cover Mounted Air Valve Internal Oil Pump X Forward Class 8	FROF16210C-P	FROF16210WEL	FROF16210CPR
RHRTL018913APH (U.S.)	Transmission, Manual, Reman, Eaton/Fuller 13-Speed Overdrive Red Internal Oil Pump X STD Class 8	RTL018913A-P	RTL018913APWEL	RTL018913APR
RHTFRO14210C (U.S.), RCFRO14210C (CAN)	Transmission, Manual, STD Shift Bar Housing	—	—	—
RHTFROF14210C (U.S.), RCFROF14210C (CAN)	Transmission, Manual, STD Reman, 10-Speed	—	—	—
RHTFOE310C (U.S.)	Transmission, Manual, Automatic	—	—	—
RHRTL016713AP (U.S.), RCRTL016713AP (CAN)	Transmission, Manual, Eaton/Fuller FLEX Reman, STD Shift Bar Housing	RTL016713A-P	RTL016713AWEL	RTL016713APR



REMAN TRANSMISSION MEDIUM

PN	DESCRIPTION	EATON/FULLER X-REF
RMTFS6406N (U.S.), RCFS6406N (CAN)	Transmission, Manual, Reman, Eaton/Fuller 6-Speed Direct Class 5, 6	FS6406N
RMTESO667B74207 (U.S.)	Transmission, Manual, Reman, Spicer/TTC 7-Speed Overdrive Class 5, 6, 7	ESO667B74207
RMTESO667B63841 (U.S.)	Transmission, Aux, TTC 1.75 1.18-09	ESO667B63841
RMTESO667B74243 (U.S.)	Transmission, Aux, TTC 1.75 1.18-09 Stud	ESO667B74243



Security on The Road

- RENEWED™ drivetrain components cost significantly less than new and offer greater reliability with re-engineered knowledge powering each component.
- Unique, best in class drive train solution that offers quality products, extensive availability, fast nationwide delivery and technical support.
- Heavy and medium duty manual transmissions, automated manual transmissions, Allison and light duty automatics, differentials, transfer cases, and steering gears.
- RENEWED drive train products are completely remanufactured, not just repaired, rebuilt or reconditioned.
- All products are backed by an International® warranty.
- TRC is an Allison and Eaton authorized rebuilder.
- All RENEWED Allison transmissions are built in a dedicated facility to Allison specifications with only Allison components.
- Authorized Eaton products leverage Road Ranger's nationwide warranty network and support functions.
- Every transmission is 100% disassembled. Each part is thoroughly cleaned, individually inspected and measured to exact OE specifications.
- Our high quality remanufacturing process turns out a high quality remanufactured transmission. This allows us to maintain low failure rates; giving you the longest warranty, best service and the least amount of down time which results in more profits to you.

fleetrite.com/renewed



DIFFERENTIALS AND DIFFERENTIAL PARTS



DIFFERENTIALS (U.S.)

PN	DESCRIPTION	DANA X-REF	WELLER X-REF	MERITOR X-REF
RRDDS404R355	Dana Differential	DS404-3.55	DS404355WEL	DS404355
RRDDS404R370	Dana Differential	DS404-3.70	DS404370WEL	DS404370
RRDDSP40R355	Dana Differential	DSP403-3.55	DSP40355WEL	DSP40355
RRDDSP40R370	Dana Differential	DSP403-3.70	DSP40370WEL	DSP40370
RRDRS404R370	Dana Differential	RS404-3.70	RS404370WEL	RS404370
MD2014X247	Meritor Differential 14X	—	MD2014X247WEL	MD2014X247
MD2014X264	Meritor Differential 14X	—	MD2014X247WEL	MD2014X264



DIFFERENTIALS (CAN)

PN	DESCRIPTION	DANA X-REF	MERITOR X-REF
RCRRL20145390	Meritor Rear Differential 145 R	—	RRL20145390
RCRPL23160391	Meritor Rear Differential 160 R	—	RPL23160391
RCRPL23160430	Meritor Rear Differential 160 R	—	RPL23160430
RCRRL20145373	Meritor Rear Differential 145 R	—	RRL20145373
RCRD20145390	Meritor Rear Differential 145 R	—	RD20145390
RCRPL23160410	Meritor Rear Differential 160 R	—	RPL23160410
RCDS404370	Dana Rear Differential 404 DS40	DS404-3.70	—



DIFFERENTIAL PARTS

PN	DESCRIPTION	DANA X-REF	MERITOR X-REF	SPICER X-REF	TRP X-REF
2589851C91	Oil Seal FWD RR Output	—	A11205Y2729	10103743	AS2729
2590276C1	Oil Seal Input Shaft (MLS) Kit	—	A11205X2728	10103742	AS2728
2590277C1	Oil Seal Pinion R145	—	A11205Z2730	10103744	AS2730
127591MTOR	Dana Pinion Seal	127591	127591MTOR	—	—
127592MTOR	Dana Pinion Seal	127592	127592MTOR	—	127592MTOR



MOBILE POWER



WET KITS

BEZARES PN	DESCRIPTION	PARKER CHELSEA X-REF
BZKPTFWKC2U	Eaton/Fuller End Dump Wet Kit 2-Line Upright Tank	TTBAXXD5UAEXBXW
BZKPTFWKC3U	Eaton/Fuller End Dump Wet Kit 3-Line Upright Tank	TTBAXXD5UAFTBBW
BZKPTFWKC2S	Eaton/Fuller End Dump Wet Kit 2-Line Saddle Tank	TTBAXXD5FAEXBXW
BZKPTFWKC3S	Eaton/Fuller End Dump Wet Kit 3-Line Saddle Tank	TTBAXXD5FAFTBBW
BZKPTWKB2U	Eaton Endurant™ End Dump Wet Kit 2-Line Upright Tank	TTBCGXJ5UAEXBXW
BZKPTWKB3U	Eaton Endurant™ End Dump Wet Kit 3-Line Upright Tank	TTBCGXJ5UAFTBBW
BZKPTWKB2S	Eaton Endurant™ Fuller End Dump Wet Kit 2-Line Saddle Tank	TTBCGXJ5FAEXBXW
BZKPTWKB3S	Eaton Endurant™ Fuller End Dump Wet Kit 3-Line Saddle Tank	TTBCGXJ5FAFTBBW

Product Information: 2-Line Wet Kits come with PTO with control and stud kit, dump pump with support bracket kit, cab console, 50 gallon aluminum tank (steel option available), complete hose and fitting kit, 1-1/4" ball valve for tank, and 1" wing quick disconnects. 3-Line Wet Kits also include a filter element and bracket.



HYDRAULIC TANKS

BEZARES PN	DESCRIPTION	MUNCIE X-REF	PARKER CHELSEA X-REF	BUYERS PRODUCTS X-REF
BZPTTA25SA	25 Gallon Saddle Aluminum Tank, Round Frame	A025R2AAGXY	SMA25	—
—	25 Gallon Saddle Steel Tank, Round Frame	S025R2AAGXY	SMS25	—
BZPTTA35SA	35 Gallon Saddle Aluminum Tank, Round Frame	A035R2AAGXY	SMA35	SMC35A
—	35 Gallon Saddle Steel Tank, Round Frame	S035R2AAGXY	SMS35	—
BZPTTA50UA	50 Gallon Upright Aluminum Tank	A050U2AAGXY	URA50	UR50A
BZPTTA50US	50 Gallon Upright Steel Tank	S050U2AAGXY	UR50S	UR50S
BZPTTA50SA	50 Gallon Saddle Aluminum Tank, Round Frame	A050R2AAGXY	SMA50	SMC50A
—	50 Gallon Saddle Steel Tank, Round Frame	S050R2AAGXY	SMS50	—



MOBILE POWER (CONT'D)



PTOS				
APPLICATION	DESCRIPTION	BEZARES X-REF	MUNCIE X-REF	PARKER CHELSEA X-REF
Allison 3000 Series™	10-Bolt, 2/4-Bolt SAE B 7/8", 13T, Direct Mount, Driver Side Shaft Low	BZPT3252PEE633SA	A20-A1007-HX3BBPX	870XDFJP-B5RK
Allison 3000 Series™	10-Bolt, 1-1/4" Keyed Shaft Remote Mount, Passenger Side Shaft Low	BZPT3252PEE631SE	A20-A1007-HX11XPX	870XDFJP-B3XV
Allison 4000 Series™	10-Bolt, 2/4-Bolt SAE B 7/8", 13T, Direct Mount, Top Side	BZPT3252PBE633SA	A20-A1005-HX5BBPX	870XAFJP-B3RK
Allison 4000 Series™	10-Bolt, 1-1/4" Keyed Shaft Remote Mount, Top Mount	BZPT3252PBE633SE	A20-A1005-HX51XPX	870XAFJP-B3XV
Allison 4000 Series™	10-Bolt, 1-1/4" Keyed Shaft Remote Mount, Driver Side Shaft Low	BZPT3252PBE633SE	A20-A1005-HX31XPX	870XAFJP-B5XV
Eaton Endurant™	8-Bolt, Air Shift, SAE B 2/4-Bolt	BZPT2010XCN751RA	TG8F-E8007-PIKX	489QHLZX-D3XK
Eaton Endurant™	8-Bolt, Air Shift, 1-1/4" Round Keyed	BZPT2010XEN751SE	TG8F-E8013-PIBH	CHL489QRLXD3XD
Eaton Endurant™	Rear Mount 95X Series-MX Engine	BZPT95X10EDA	—	—
Eaton/Fuller	8-Bolt, Air Shift, 2/4-Bolt SAE B 7/8", 13T, Direct Mount	BZPT2000XCNO11RA	TG8S-U6807-A1KX *	489XHAHX-A3XK
Eaton/Fuller	8-Bolt, Air Shift, 2/4-Bolt SAE B 7/8", 13T, Direct Mount	BZPT2000XJNO11RA	TG8S-U6812-PIKH	489XRAHX-V3XK
Eaton/Fuller	Heavy-Duty 8-Bolt, Air Shift, Double Acting, SAE C 7/8", 13T	BZPT8500XEN011RK	828S-U6808-D1EX	880XJAHX-V3XS



*1410 Companion Flange instead of 1-1/4" Keyed

PUMP					
GPM AT 1000 PUMP RPMS	APPLICATION	DESCRIPTION	BEZARES X-REF	MUNCIE X-REF	PARKER CHELSEA X-REF
27 GPM	Dump Pump for Eaton/Fuller Manual Transmissions	SAE 4-Bolt 7/8", 13T, Direct Mount, Air Shift, Rear Pipe Ports, CCW, 2 or 3 Line	BZPTBZ102LAS25	E2XA1-27-02BPRL	314-9325-227
27 GPM	Dump Pump for Allison and some Mack Transmissions	SAE 4-Bolt 7/8", 13T, Direct Mount, Air Shift, Rear Pipe Ports, CW, 2 or 3 Line	BZPTBZ102RAS25	E2XA1-27-02BPRR	314-9325-226
26 GPM	Birotational Bushing Gear Pump	SAE B, 13T, 1-1/2" NPT Ports	BZPTBELA26N12	X2702BJOHEHEA14	—
26 GPM	Birotational Bushing Gear Pump and Dual Tipper Valve	SAE B, 13T, 1-1/4" O-Ring Ports, Dual Tipper Valve	BZPTBELA26S20, BZPT9030890	PL1-27-02BPBL-20, D182PP2PCCO	—
15 GPM	Allison Transmissions with Single Axle Dump Body	SAE 4-Bolt 7/8", 13T, Direct Mount, Lever Shift, Rear Pipe Ports, CW, 2 or 3 Line	BZPTBZG102RMS20	S2LD1-15-02BPRR	308-9310-416
15 GPM	Manual Transmissions with Single Axle Dump Body	SAE 4-Bolt 7/8", 13T, Direct Mount, Lever Shift, Rear Pipe Ports, CCW, 2 or 3 Line	BZPTBZG102LMS20	S2LD1-15-02BPRL	308-9310-418
15 GPM	Driveline from PTO to Pump	1" Dual Shaft 1/4" Key, Remote Mount, Lever Shift, Rear Pipe Ports, 2 or 3 Line	BZPTBZG10120	S2LD1-15-01RPRB	308-9310-047



Quality All-Makes Parts You Can Depend On

Fleetríte® clutches are offered with a wide range of torque ratings and damper configurations to ensure that you get the right clutch for your truck. This product line offers a complete range of options for Class 6, 7 and 8 vehicles, are Navistar aftermarket quality approved and backed by a one-year unlimited mile warranty when installed at an International or IC Bus location.

Angle Spring® Clutch Assemblies

- Original clutch technology
- Manual adjust mechanism
- 14" and 15" units available

Easy Effort® Clutch Assemblies

- Direct replacement for Easy Pedal Advantage® clutch
- Spring-A-Just mechanism
- Multiple application compatibility

Medium-Duty Clutch Assemblies

- Most complete line of new clutch assemblies for Class 6 and 7 vehicles
- 310mm, 330mm, 350mm, 365mm and 14" units available
- Push and Pull-style clutch assemblies

Supplemental Parts

- Essential parts for a successful clutch installation
- Prevent misalignment
- Ensure smooth engagement

fleetríte.com



DRIVELINE COMPONENTS



U-JOINTS

MERITOR GENUINE PN	DESCRIPTION	FLEETRITE X-REF	DANA SPICER X-REF	TRP X-REF
170N7018X	Bolt Kit, U-Joint Bolt and Retainer Set	—	170 -70 -18X	DS17070 -18X
250N7018X	Bolt Kit, U-Joint Bolt and Retainer Set	—	250 -70 -18X	DS25070 -18X
CP103X	U-Joint, Series 1000	FLT103Q	5 -103X	SS103
M279X	U-Joint, Series 1610 Full Round	—	—	—
M280X	U-Joint, Series 1710 Full Round	FLT15280X	5 -280X	DS15 -280X
M281X	U-Joint, Series 1810 Full Round	FLT15281X	5 -281X	DS15 -281X
M674X	U-Joint, Series 1710 Half Round	—	—	—
M675X	U-Joint, Series 1710 Half Round	FLT15675X	5 -675X	DS15 -675X
M676X	U-Joint, Series 1810 Half Round	FLT15676X	5 -676X	DS15 -676X
M677X	U-Joint, Series 1760 Half Round	FLT15677X	5 -677X	DS15 -677X
KT17SB	Strap and Bolt Kit, Series 1710, 1810 Half Round	—	6.5 -70 -18X	DS6.5 -70 -18X
90N7028X	Strap and Bolt Kit, Series SPL90, SPL100 Half Round	—	90 -70 -28X	—
US90X	U-Joint, Series SPL100	—	SPL100 -1X	—
US170X	U-Joint, Series SPL170	FLT15170X	SPL170 -4X	DS170 -4X
US250X	U-Joint, Series SPL250	—	SPL250 -3X	DS250 -3X
CP20RPLS1	U-Joint, Series RPL20	—	35 -RPL20X	DS15 -RPL20X
CP25RPLS1	U-Joint, Series RPL25	—	35 -RPL25X	DS15 -RPL25X
CP35RPLS	U-Joint, Series RPL35	—	—	—



YOKES

MERITOR GENUINE PN	DESCRIPTION	DANA X-REF
—	Yoke Kit, SPL170 Series, Includes 5008451 Yoke and 131095 Nut, 2.544-49	131434K
—	Yoke Kit, 1710 Series, Includes 5008450 Yoke and 131095 Nut, 2.544-49	131438K
—	Yoke Kit, 1810 Series, Includes 5008437 Yoke and 131095 Nut, 2.544-49	131447K
170N42811X	Yoke Assembly, End SPL170, 2.024-39 Involute Spline with Slinger	170-4-281-1X
250N42711	Yoke Assembly, End SPL250, 2.794-54 Half Round	250-4-271-1
250N4811X	Yoke Assembly, End SPL250, 2.274-44 Half Round	250-4-81-1X
—	Drive Shaft Companion Flange, 1350 Series	3-1-303-7
141N42631	Yoke, Bearing and Strap, 1410 Series, Round Shaft 1-1/2"-3/8" Keyway	3-4-263-1
141N821191	Yoke Shaft	3-82-1191
17N489911X	Yoke Assembly, End 1710 Series, 2.024-39 Half Round with Slinger	6-4-8991-1X
17N490011X	Yoke Assembly, End 1710 Series, 2.024-39 Half Round with Slinger	6-4-9001-1X
18N435911	Yoke, 1810 Series, 2.39-46 Half Round	6.5-4-3591-1
18N445711X	Yoke, 1810 Series, 2.274-44 Half Round	6.5-4-4571-1X
18TYS45	Yoke, 1810 Series, 2.794-54 Half Round	6.5-4-4631-1
17XHS	Drive Shaft 1710 Series, Tube Size 4" x .134", Tube Length 4.656", Slip 5.25"	819986-0421



CENTER BEARINGS

MERITOR GENUINE PN	DESCRIPTION	DANA X-REF	TRP X-REF
CB2106611XSA	Center Bearing Assembly, 1810 Series	10094142	DS210661-1X
CB2100842X	Center Bearing Assembly, 1610 Series	210084-2X	DS210084-2X
CB2100881X	Center Bearing Assembly, 1280/1310 Series	210088-1X	—
CB2101211XSA	Center Bearing Assembly, 1710 Series	210121-1X	DS210121-1X



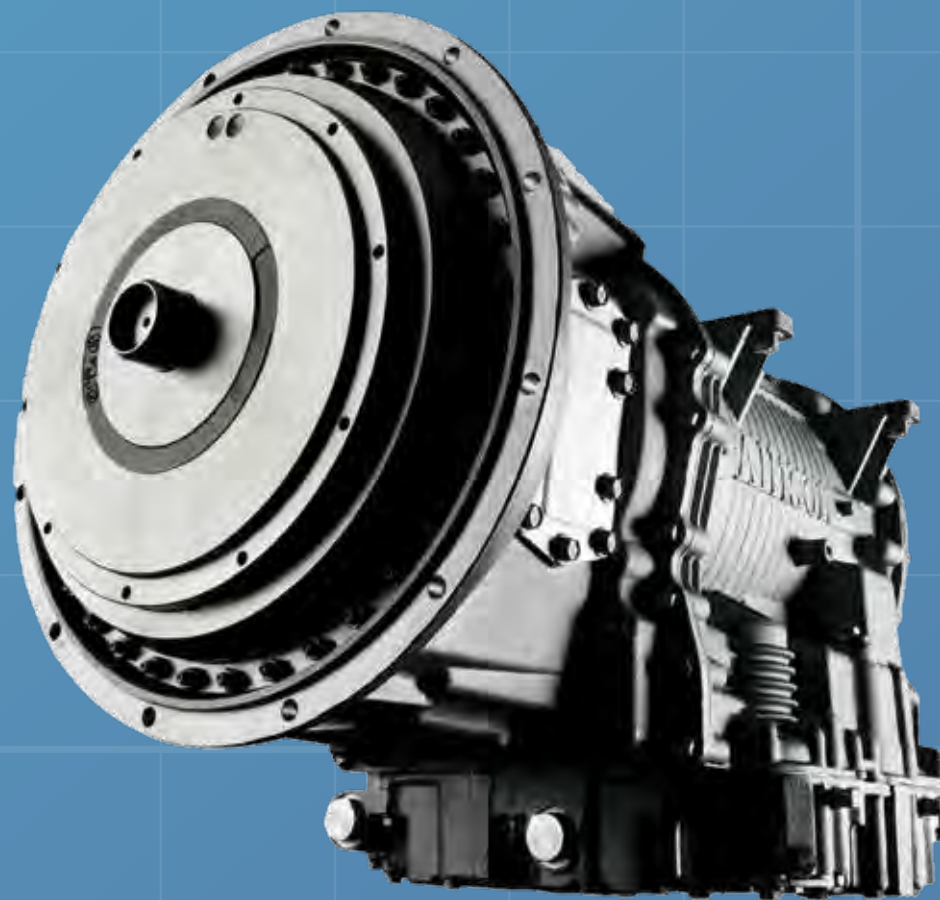

WHEN IT COMES TO TRANSMISSION
IT'S TIME TO ADAPT TO A
RENEWED WAY OF THINKING.

Also Available By RENEWED: Heavy-Duty and Medium-Duty Manual Transmissions, Automated Manual Transmissions, Allison and Light-Duty Automatics, Differentials, Transfer Cases and Steering Gears.

All Products Are Backed By An International® Warranty.





**THE POWER FOR YOUR LIFE
ON THE ROAD.**

Time to trade up to a more powerful, longer lasting battery.

Order online at RepairLinkShop.com

PARTS FIT TO PERFORM

fleetrite.com



**DELCO REMY ALL-MAKES PREMIUM
STARTERS AND ALTERNATORS.**

All-Makes Premium starters and alternators allow you to service a broader range of commercial vehicles, All-Makes and all models.

**WE START THE WORLD AND
KEEP IT RUNNING!**

delcoremy.com

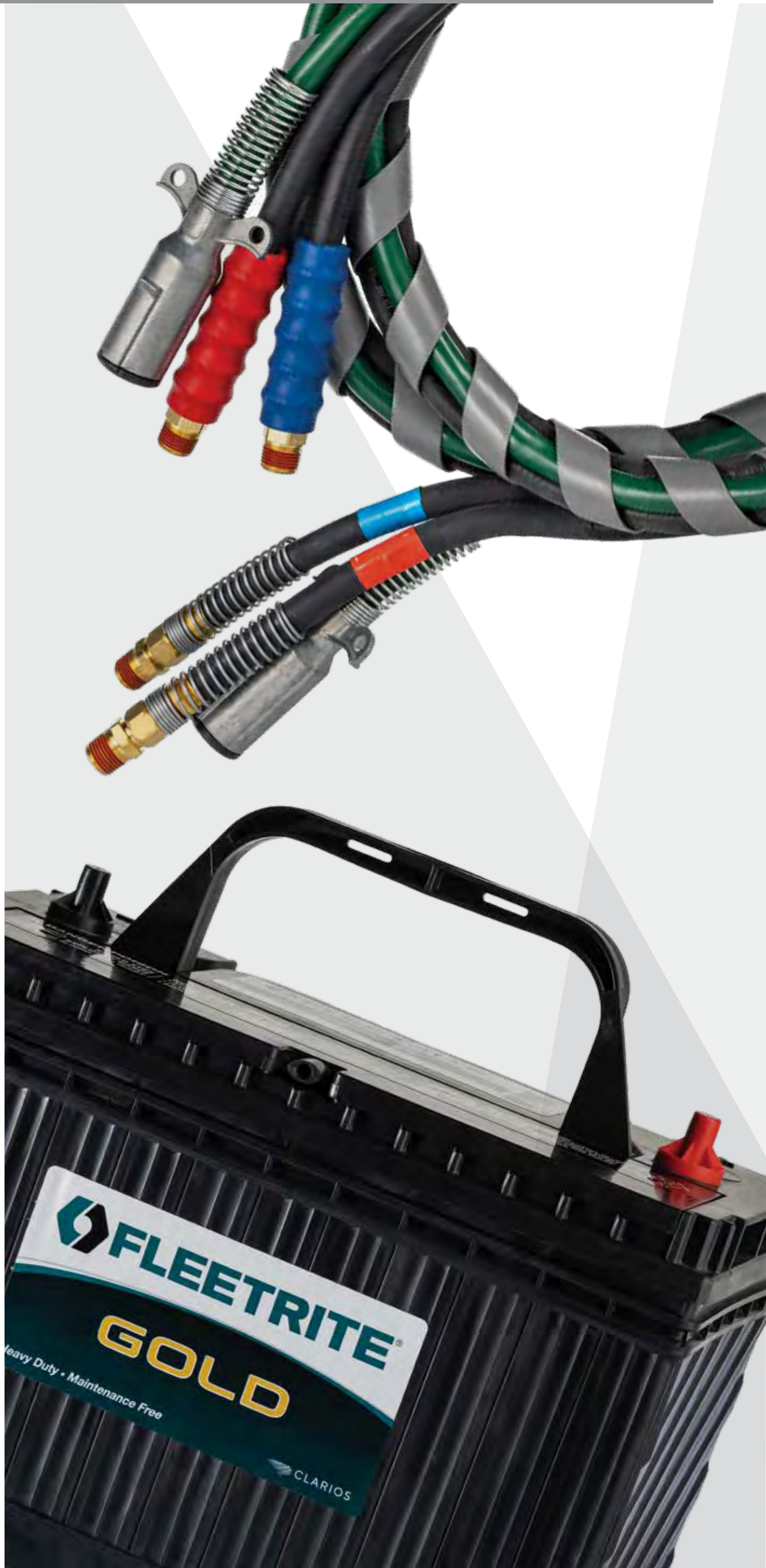

ROTATING ELECTRICAL



DELCO REMY ALTERNATORS

PN	DESCRIPTION	APPLICATION	AMPS	TYPE	MOUNT	REMAN X-REF	LEECE-NEVILLE X-REF	BOSCH X-REF	DENSO X-REF	TRP X-REF	ALLIANCE X-REF
8600094	40SI™	Line Haul Tractor, City Tractor, School Bus	275	Brushless	Pad	—	A0014942PA, A0014944PA, A0014947PA, A0014949PA, A0014949GH, A0014975PAA	—	—	—	40SI Hinge Mount
8600279	40SI™	—	275	Brushless	J-180 Short Hinge	—	—	—	—	—	—
8600280	40SI™	Line Haul Tractor, City Tractor, School Bus	275	Brushless	J-180 Long Hinge	—	A0014856AA, A0014867JB, A0014867JGH, A0014870AA, A0014870JB, A0014871JB, A0014872AA, A0014872JB	—	—	—	—
8600298	40SI™	Line Haul Tractor, City Tractor, School Bus	300	Brushless	Pad	—	—	—	—	—	—
8600299	40SI™	—	300	Brushless	J-180 Short Hinge	—	—	—	—	—	—
8600300	40SI™	Line Haul Tractor, City Tractor, School Bus	300	Brushless	J-180 Long Hinge	—	—	—	—	—	—
8600338	40SI™	Universal Fit	240	Brushless	Pad	—	BLP2332GH, BLP2334GH, A0014940PA, A0014948PA, A0014951PGH, A0014958PA, A0014959PA	—	—	—	—
8600339	40SI™	—	240	Brushless	J-180 Short Hinge	—	—	—	—	—	—
8600390	40SI™	—	240	Brushless	J-180 Long Hinge	—	A0014850AA, A0014860AA, A0014860JB, A0014861JB, A0014863JB, A0014868JGH, A0014884JB, A0014885JB, A0014887JB, A0014852AA, A0014869JB, A0014873JB, A0014854AA	—	—	—	—
8600628	40SI™	Line Haul Tractor, City Tractor, School Bus	320	Brushless	Pad	—	A0014962PA, A0014962PAH, A0014966PAA	—	—	—	—
8600634	40SI™	Line Haul Tractor, City Tractor, School Bus	320	Brushless	J-180 Long Hinge	—	A0014890AA, A0014890JB, A0014892AA	—	—	—	—
8600125	36SI™	Universal Fit	170	Brushless	Quad	8700045	—	—	—	—	—
8600126	36SI™	Universal Fit	170	Brushless	J-180 Short Hinge	8700046	110-800, 110-801, 110-802, 110-803, 110-804, BLD2301, BLD2302, BLD2305, BLD2307, BLD2308	—	101211-8050, 101211-8060, 101211-8120	D27-6001-0130J	36SI Hinge Mount
8600127	36SI™	Universal Fit	170	Brushless	Pad Mount	—	110-810, 110-811, 110-812, 110-813, 110-814, 110-815, 110-816, BLP2303, BLP2304, BLD2305, BLD2306, BLD2309, BLD2310, BLD2311, BLD2312	—	101211-8380, 101211-8390	D27-6001-1030P	—
8600078	28SI™	—	180	Brush	Pad	—	—	—	—	—	28SI Hinge Mount
8600201	28SI™	Connector, Freightliner	160	Brush	Pad	8700080	—	—	—	—	—
8600315	28SI™	Universal Fit	160	Brush	Pad	—	—	—	—	—	—
8600223	28SI™	—	180	Brush	J-180 Short Hinge	—	—	—	—	—	—
8600253	28SI™	—	200	Brush	Pad	8700082	—	—	—	—	—
8600307	28SI™	Universal Fit	200	Brush	J-180 Long Hinge	8700083	2331GH, 2333GH, 4836AAH, 4836LGH, 4846AAH, 4850AA, 4860AA, 4860JB, 4861JB, 4863JB, 4868JGH, 4884JB, A0014836AAH, A0014836LGH, A0014846AAH, A0014850AA, A0014860AA, A0014860JB, A0014863JB, A0014868JGH, A0014884JB, BLD2333GH, BLD2331GH	—	—	—	—
8600308	28SI™	—	160	Brush	J-180 Long Hinge	—	2800LC, 2801LC, 2802LC, 2824LC, 2825LC, 2828LC, 2913LC, A0012800LC, A0012802LC, A0012824LC, A0012825LC, A0012828LC, A0012913LC, A002801LC	—	—	—	—
8600311	28SI™	—	180	Brush	J-180 Long Hinge	—	110-775, 2800LC, 2801LC, 2802LC, 2824LC, 2825LC, 2828LC, 2913LC, 8LHA2275V, A0012800LC, A0012802LC, A0012824LC, A0012825LC, A0012828LC, A0012913LC, A002801LC	—	—	—	—
8600314	28SI™	Universal Fit	200	Brush	Pad	8700088	4939AAH, 4939PGH, 4940PA, 4943PGH, 4945AAH, 4948PA, 4951PGH, A0014939AAH, A0014939PGH, A0014940PA, A0014943PGH, A0014945AAH, A0014948PA, A0014951PGH	AL9962SB	—	—	—
8600312	28SI™	—	160	Brush	J-180 Short Hinge	—	—	AL9960LH	—	—	—
8600313	28SI™	Universal Fit	200	Brush	J-180 Short Hinge	8700087	—	AL9963SB	—	—	—
8600315	28SI™	Universal Fit	160	Brush	Pad	—	—	AL9961LH	—	—	—
8600316	28SI™	—	180	Brush	Pad	—	8LHP2276V, 110-775P	—	—	—	—
8600426	28SI™	—	200	Brush	J-180 Short Hinge	—	—	—	—	—	—

ROTATING ELECTRICAL (CONT'D)



DELCO REMY ALTERNATORS (CONT'D)

PN	DESCRIPTION	APPLICATION	AMPS	TYPE	MOUNT	REMAN X-REF	LEECE-NEVILLE X-REF	BOSCH X-REF	DENSO X-REF	TRP X-REF	ALLIANCE X-REF
8600889	24SI™	Universal Fit	160	Brush	Pad	—	110-555	AL9960LH	—	—	24SI Pad Mount
8600310	24SI™	Universal Fit	160	Brush	J-180 Hinge	—	110-555	AL9960LH	—	—	—



LEECE-NEVILLE ALTERNATORS

PN	DESCRIPTION	APPLICATION	AMPS	TYPE	MOUNT	DELCO X-REF	FLEETRITE X-REF	TRP X-REF	ALLIANCE X-REF
110-555JHO	12V	Class 4 - 8 Truck	160	Brush	J-180 Hinge	—	FLTAL1110160J	—	—
110-555PHO	12V	Class 4 - 8 Truck	160	Brush	Pad	—	FLTAL1110160P	—	—
AVI555J	12V, AVI, Dual Internal Fan	Class 4 - 8 Truck	170	Brush	J-180 Hinge	10459013, 10459017, 10459026, 10459035, 10459036, 10459037, 10459038, 10459043, 10459044, 10459045, 19020310, 8600310, 8600452, 8600198, 8600199, 10459046, 10459048, 10459050, 10459051, 10459052, 10459054, 19010154, 19010158, 19010159, 19010160, 19010194, 19010209	FLTAL124160J, FLTAL555170J	—	22PJ150, 24J160
AVI555P	12V, AVI, Dual Internal Fan	Class 4 - 8 Truck	170	Brush	Pad	8600227, 8600231, 8600315, 8600405, 8600519, 8600889, 8700012, 10459318, 10459320, 10459321, 10459341, 19020387, 19020388, 19020389, 19020803, 19020804, 19020889, 19090001, 19090005, 61009223, 61009226, 61010752	FLTAL124160P	RE24P	22P150, 24P160
A160211	12V, AVI 160	School Bus, Truck, Specialty Vehicles	170	Brush	J-180 Hinge	8600308	—	—	—
A160210	12V, AVI 160	School Bus, Truck, Specialty Vehicles	170	Brush	Pad	8600315	—	—	—
A160208	12V, AVI 160	School Bus, Truck, Specialty Vehicles	210	Brush	J-180 Hinge	8600307, 61009625, 8700083	FLTAL128200J	—	28LH200, ABP N15 AVI2008J210
A160207	12V, AVI 160	School Bus, Truck, Specialty Vehicles	210	Brush	Pad	8600314, 8600318, 8600417	FLTAL128200P	—	28P200
A160204	12V, AVI 160	School Bus, Truck, Specialty Vehicles	240	Brush	J-180 Hinge	—	—	—	ABP N15 VI2004J240
A160203	12V, AVI 160	School Bus, Truck, Specialty Vehicles	240	Brush	Pad	—	—	—	ABP N15 AVI2003P240
BLP4007H	12V	School Bus, Truck, Specialty Vehicles	240	Brushless	Pad	8600338, 8600412, 8600784, 8600785, 8600599	—	—	—
BLP4009	12V	School Bus, Truck, Specialty Vehicles	280	Brushless	Pad	8600094, 8600478, 8600603	—	—	—
BLP4004H	12V	School Bus, Truck, Specialty Vehicles	350	Brushless	Pad	8600628	—	—	—
BLD4012	12V	School Bus, Truck, Specialty Vehicles	350	Brushless	J-180 Hinge	8600280, 8600299, 8600300, 8600634, 8600755	—	—	—



DELCO REMY ALTERNATOR UPGRADES

PN	REPLACEMENT PN	DESCRIPTION
8600889	8600315	Upgrade from 24 to 28SI™ for Higher Idle Amp
8600310	8600308	Upgrade from 24 to 28SI™ for Higher Idle Amp
8600127	8600338	Upgrade from 36 to 40SI™ for Higher Idle Amp
8600126	8600339	Upgrade from 36 to 40SI™ for Higher Idle Amp

Upgrade options for better performance.

MITSUBISHI ALTERNATORS

PN	APPLICATION	AMPS	TYPE	MOUNT
AM0071	All 12V Pad Mount Applications	200	Brushless	Pad
AM1771	All 12V Pad Mount Applications	160	Brushless	Pad



ROTATING ELECTRICAL (CONT'D)



FLEETRITE ALTERNATORS

PN	DESCRIPTION	APPLICATION	AMPS	TYPE	MOUNT	DELCO X-REF	LEECE-NEVILLE X-REF	BOSCH X-REF	WILSON X-REF
FLTAL124160P	24 12V	Class 4 – 8 Truck	160	—	Pad	8600889, 8700008, 8700012, 8700013, 10459320, 10459321	—	AL9961LH	90-01-4577N
FLTAL122150J	22 12V	Class 4 – 8 Truck	150	—	J-180	10459105, 10459118, 10459156, 10459205, 10459216, 10459217, 10459254, 10459301, 1117911, 1117916, 1117917, 1117919, 1117921, 1117924, 1117929, 1117933, 1117947, 1117948, 1117949, 1117952, 19010153, 19010155, 19010156, 19010173, 19010212, 19020306, 19020309, 19020310, 19020356, 19020358, 19020361, 19020381, 19020399	—	—	90-01-4295, 90-01-4295N, 90-01-4297
FLTAL128200P	28 12V	Truck, School Bus	200	—	Pad	8600314, 8600315, 8600316, 8600417	—	AL9962SB	90-01-4720N, 90-01-4723N
FLTAL122150P	22 12V	Class 4 – 8 Truck	150	—	Pad	10459318, 10459320, 10459321, 10459341, 19020387, 19020388, 19020389, 19020803, 19020804, 19020888, 19020889	—	—	90-01-4391, 90-01-4392, 90-01-4392N, 90-01-4393, 90-01-4393N
FLTAL110160P	12V, 110-555	Class 4 – 8 Truck	160	—	Pad	—	110-555PHO	—	—
FLTAL135140P	35 12V	Class 4 – 8 Truck	140	Brushless	Pad	10459606, 10459609, 10459612, 19011227, 19011228, 19011229, 19011231, 19011232, 19011233, 19011248, 19011260, 19011263, 19011264, 8600159, 87000000, 87000005, 87000023, 87000024, 87000026, 87000028	—	—	90-01-4344, 90-01-4513, 90-01-4773

**IdlePro High Amp Alternators**

IdlePro® alternators, available in 170-, 190-, 210- and 240-amps of service – deliver industry-best output at low engine speeds through an innovative brushed, dual internal fan design. IdlePro alternators include a host of features that help extend battery life and increase vehicle uptime by enhancing electrical system and engine performance.

idleproextreme.com

**PowerPro 7 Heavy-Duty Gear Reduction Design Starters**

PowerPro® 7 starters offer unmatched reliability and performance in a space-saving package. These high-torque starters for heavy duty-diesel engines up to 16L include a heavy-duty gear reduction design that delivers 12V 7kW starting power. PowerPro 7 starters can help to significantly reduce overall operating costs and maintenance related downtime.

powerprostarters.com

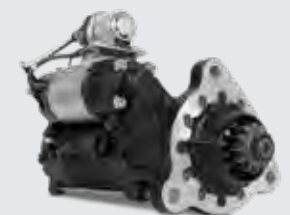

ROTATING ELECTRICAL (CONT'D)



DELCO REMY NEW STARTERS

PN	DESCRIPTION	PINION TEETH	SOLENOID POSITION	ROTATION	OVER-CRANK PROTECTION	APPLICATION	LEECE-NEVILLE X-REF	MITSUBISHI X-REF	DENSO X-REF
8200287	39MT™	12	82	Clockwise	Yes	Mercedes-Benz MBE 4000	—	FL1179	—
8200291	39MT™	12	38	Clockwise	Yes	Volvo D12	—	VV0279	—
8200308	39MT™	11	82	Clockwise	Yes	Detroit Diesel® Series 60® (S60®); CAT C9, C10, C11, C12, C13, C15; Cummins ISM, M11, N14, ISX 15; MaxxForce® 15; Mack E7	—	PC1479, PC00779, PC1879, PC1479, PC0779	—
8200971	39MT™	11	52	Clockwise	Yes	Cummins ISX 12	—	—	—
8200433	39MT™	12	82	Clockwise	Yes	Cummins ISC, ISL; MaxxForce® 9, 10, 11, 13; PACCAR PX-8, PX-9; International DT466, DT530, DT570, HT570	—	PC1379, PC72679, PC2679	—
8200434	39MT™	12	292	Clockwise	Yes	DD13®, DD15®, DD16® 2015 and Earlier	—	FL0189	—
8200468	39MT™	11	243	Clockwise	Yes	Mack MP7, Volvo D11	—	MK1078, MK1075, VV1076	—
8200469	39MT™	12	52	Clockwise	Yes	Mack MP10, Volvo D16	—	MK1978, VV0879, VV1979	—
8201100	39MT™	12	251	Clockwise	Yes	Mack MP8, Volvo D13	—	MK2078, VV2079	—
61008898	39MT™	11	292	Clockwise	Yes	DD13®, DD15®, DD16® 2016 – Current	—	—	—
8200075	38MT™	11	315	Clockwise	No	Freightliner FL360, FL50, FL60, FL70, FL80, FS65, M2, M2 106; Sterling Truck Acterra 550, Acterra 6500, Acterra 7500, Acterra 8500	—	—	—
8200076	38MT™	10	128	Clockwise	No	Autocar LLC., Blue Bird, Capacity of Texas, El Dorado, Freightliner, Gillig, IC Corporation, International, Kalmar, Kenworth and Peterbilt, New Flyer, Sterling Truck, Thomas	—	—	—
8200077	38MT™	10	315	Clockwise	No	Cummins ISB	—	PC1779	—
8200977	38MT™ +	12	68	Clockwise	No	PACCAR MX 11, 13	—	PC0079	—
8201084	38MT™ +	12	68	Clockwise	Yes	PACCAR MX 11, 13	—	PC2578	—
61005264	31MT™	10	55	Clockwise	No	Cummins ISB, 5.9L, 4BT, 3.9L	—	—	428000–1600, 228000–1953, 228000–7301, 428000–8400, 228000–3811
61005265	31MT™	10	315	Clockwise	No	Cummins ISB, 5.9L, 4BT, 3.9L	—	—	428000–1600, 228000–1953, 228000–7301, 428000–8400, 228000–3811
61005266	31MT™	10	55	Clockwise	No	MaxxForce® 7, 6.4L, VT365, 6.0L	M105603	—	428000–0071
61006208	31MT™	9	315	Clockwise	No	MBE 900, 7.2L, MBE 904, 4.3L, MBE 906, 6.4L	—	—	428000–8470, 428000–1881
61006209	31MT™	10	320	Clockwise	No	Cummins ISB, 6.7L without Ground Stud, Low Profile Turbo	—	—	—
61006210	31MT™	10	315	Clockwise	No	PACCAR PX-7; Cummins ISB, 6.7L	M105610	M009T71779, PC1779	428000–7090, 438000–3110
61006211	31MT™	10	315	Clockwise	No	Cummins ISB, 6.7L	M105610	M009T71779, PC1779	428000–5230, 428000–7090, 438000–3110, 428000–9340
61014400	150MT™	11	82.5	Clockwise	Yes	Detroit Diesel® Series 60® (S60®); CAT C9, C10, C11, C12, C13, C15; Cummins ISM, M11, N14, ISX 15; MaxxForce® 15; Mack E7	M110603, M39308	PC1479, IN1478, FL0975, FL0777, FL0579	—
61015900	150MT™	11	292.5	Clockwise	Yes	DD13®, DD15®, DD16® 2016 – Current	M110613, M110R2613SE	FLA579	—
61017311	150MT™	12	82.5	Clockwise	Yes	Cummins ISC, ISL; MaxxForce® 9, 10, 11, 13; PACCAR PX-8, PX-9; International DT466, DT530, DT570, HT570	M110610, M110606, M105602, M105302, M39433	PC1379, PC2679, PC72679, IN1378, IN3179	428000–2690, 228000–5311
61015901	150MT™	11	82.5	Clockwise	Yes	CAT C12, C13, C15; Cummins ISM, ISX, N14; Detroit Diesel® Series 60® (S60®); Mack E7	M105732	PV2479, PC83579, MC2378	—



ROTATING ELECTRICAL (CONT'D)



DELCO REMY STARTER UPGRADES

PN	DESCRIPTION	PINION TEETH	SOLENOID POSITION	ROTATION	OVER-CRANK PROTECTION	APPLICATION	MITSUBISHI X-REF	TRP X-REF
61003201	39MT™ Smart Starter	11	082	Clockwise	Yes	CAT C9, C10, C11, C12, C13, C15; Cummins ISX, ISM; Detroit Diesel® Series 60*; Mack E7	MIB970975, MIB970975FL, FL0975, MIB970777, MIB970777FL, FL0777, FL0579, 3815734C91, IN1478, PC0979, PC1479, PC1879, M983579, MK0077, VV0776, VV0977	D61-6002-004, D61-6002-008
61003202	39MT™ Smart Starter	11	082	Clockwise	Yes	24V Detroit Diesel® Series 60*; Cummins ISM, ISX, N14; CAT C12, C13, C15; Mack E7	510752, PV2479, 71-01-1008, MC2378	—

Upgrade options for better performance.

DELCO REMY REMANUFACTURED STARTERS

DELCO REMY PN	DESCRIPTION	PINION TEETH	SOLENOID POSITION	ROTATION	OVER-CRANK PROTECTION	APPLICATION
10461052	42MT™	11	82	Clockwise	No	Heavy-Duty Straight Drive
10461053	42MT™	11	88	Clockwise	No	Heavy-Duty Straight Drive
10461055	42MT™	11	82	Clockwise	Yes	Heavy-Duty Straight Drive
10461075	42MT™	11	88	Clockwise	Yes	Heavy-Duty Straight Drive



MITSUBISHI NEW STARTERS

PN	DESCRIPTION	PINION TEETH	SOLENOID POSITION	ROTATION	OVER-CRANK PROTECTION	APPLICATION	DELCO X-REF	LEECE-NEVILLE X-REF	FLEETRITE X-REF	TRP X-REF
IN0971	12V, Diamond Power 90P47	12	57°	CW	No	International with Cummins ISB Engine 2014 – Current	8200055, 8200077, 8200371, 8200375, 8200571, 8200796, 8200834, 8200959, 8201002, 8201039, 8300064, 10461431, 10461496, 10479226, 10479242, 61006210, 61006211	M105610, M95303H, M38077	—	—
VV0776	12V, Diamond Power 105P55	11	0°	CW	No	Volvo with Cummins ISX 2007 – Current	8200091, 8200289, 8200308, 8200319, 8200662, 8200820, 8201078, 8201079, 8300009, 8300031, 19011516, 19011517, 19011530, 61003778, 61003779, 22398232	M110R2603SE, M110R2603SE2D, M110R2603SE-2D, M125601, M110603	—	REN3908
VV0879	12V, Diamond Power 105P55	12	6°	CW	No	Volvo with Volvo D16 2005 – 2006	8200087, 8200182, 8200469, 8200610, 8201072, 8300061	M110606	—	REN3933
MK1075	12V, Diamond Power 105P55	11	36°	CW	No	Mack with Mack MP7 2007 – Current	8200223, 8200468, 8200612, 8201074, 8300059, 61003774, 22398213	M105352	—	—
VV1076	12V, Diamond Power 105P55	11	36°	CW	No	Volvo with Volvo D11 2007 – Current	8200223, 8200468, 8200612, 8201073, 8300059, 61003773, 22398213	M105352	—	—
PC1379	12V, Diamond Power 105P55	12	343.5°	CW	No	Kenworth and Peterbilt with Cummins ISC, ISL-Non RPTO 1998 – Current	1990379, 1990394, 1993795, 3921012, 8200005, 8200081, 8200374, 8200433, 8200457, 8200625, 8200763, 8200768, 8200808, 8200836, 8200958, 8201080, 8201081, 8300005, 8300007, 8300015, 10461021, 10461050, 10461051, 10461169, 10461171, 61003780, 61003781, 90027707	LN105602, M105602, M105613	—	REN3933
IN1378	12V, Diamond Power 105P55	12	348°	CW	No	International DT466, DT530, HT570 1998 – Current; International MaxxForce® DT, DT9, DT10, N9, N10 1998 – Current; Cummins ISL 2014 – Current	1048812, 1993795, 8200005, 8200081, 8200210, 8200217, 8200218, 8200219, 8200251, 8200252, 8200253, 8200360, 8200384, 8200433, 8200470, 8200635, 8200639, 8200659, 8200664, 8200672, 8200770, 8200857, 8300005, 8300007, 8300015, 8300062, 8300065, 8300074, 8300078, 10461169, 10461171, 10461304, 10478999	M105302, M105602, M105R2502SE, M110606, M110610, M95301H, M95312H, M38005	—	REN3933
PC1479	12V, Diamond Power 105P55	11	0°	CW	No	Kenworth with CAT C15, C15 ACERT™ 1998 – 2006; Kenworth and Peterbilt with CAT C9, C10, C12 1998 – 2003; CAT C11 ACERT™ 2004 – 2006; CAT C9, C13 ACERT™ 2004 – 2010; CAT C15, C15 ACERT™ 2007 – 2010; Cummins ISX, ISM, N14 1998 – Current	1990363, 1990490, 8200104, 8200164, 8200165, 8200168, 8200290, 8200308, 8200405, 8200741, 8200742, 8200750, 8300000, 8300033, 8300034, 10461053, 10461778, 19011529	M110R2603SE, M110R2603SE2D, M110R2603SE-2D, M110R2615SE2D, M125601, M110603	—	REN3908

ROTATING ELECTRICAL (CONT'D)



MITSUBISHI NEW STARTERS (CONT'D)

PN	DESCRIPTION	PINION TEETH	SOLENOID POSITION	ROTATION	OVER-CRANK PROTECTION	APPLICATION	DELCO X-REF	LEECE-NEVILLE X-REF	FLEETRITE X-REF	TRP X-REF
IN1478	12V, Diamond Power 105P55	11	0°	CW	No	International with Cummins ISX, ISM, N14, M11 1998 - Current; CAT C12, C15 1998 - 2003; CAT C13, C15 ACERT™ 2004 - 2009; International MaxxForce® 15 all years	8200033, 8200050, 8200091, 8200247, 8200289, 8200308, 8200312, 8200313, 8200409, 8200604, 8200605, 8200640, 8300009, 8300079, 61010754, 61011314, DRA8200604, 10461045	LNMI25601, M110603, M110R2603SE, M110R2603SE2D, M110R2603SE-2D, M110R2615SE2D, M125601, M39308, ZLNM125601	—	REN3908
PC1779	12V, Diamond Power 105P55	12	26°	CW	No	Kenworth and Peterbilt with Cummins ISB 2007 - Current	8200077, 8200235, 8200796, 8300024, 10461496, 10479242, 61006210	M105610, M95303H	—	—
PC1879	12V, Diamond Power 105P55	11	187°	CW	No	Kenworth and Peterbilt with CAT C13 ACERT™ with RPTO 2007 - 2010	8200290, 8200308, 1990352, 1990483	M110R2603SE, M110R2603SE2D, M110R2603SE-2D, M110R2615SE2D, M125601, M110603	—	REN3908
MK1978	12V, Diamond Power 105P55	12	6°	CW	No	Mack with Mack MP10 2007 - Current	8200182, 8200469, 8200610, 8201072, 8300061, 61003772	M110606	—	REN3933
VV1979	12V, Diamond Power 105P55	12	6°	CW	No	Volvo with Volvo D16 2007 - Current	8200182, 8200469, 8200610, 8201071, 8300061, 61003771	M110606	—	REN3933
MK2078	12V, Diamond Power 105P55	12	215°	CW	No	Mack with Mack MP8 2007 - Current	8200214, 8200417, 8200572, 8200611, 8200910, 8201076, 8201100, 8300060, 61002699, 61003776, 61011317, DR61003775	M110602	—	—
VV2079	12V, Diamond Power 105P55	12	215°	CW	No	Volvo with Volvo D13 2007 - Current	8200214, 8200417, 8200572, 8200611, 8200909, 8201075, 8201100, 8300060, 61002699, 61003775, DR61003775	M110606	—	—
PC2679	12V, Diamond Power 105P55	12	347.2°	CW	No	Kenworth and Peterbilt with Cummins ISC, ISL with RPTO 1998 - Current	1990405, 1993795, 3921012, 8200005, 8200374, 8200433, 8200625, 8200768, 8200836, 8200958, 8201080, 8201081, 8300007, 8300015, 10461169, 10461171, 20469961, 61003780, 61003781, 90027707, 8200763	LNMI05602, M105602, M110610	—	—
MK2878	12V, Diamond Power 105P55	12	334°	CW	No	Mack; Kenworth and Peterbilt with Cummins ISX 11.9L, ISX-G 11.9L 2010 - Current	8200793, 8200915, 8200960, 8200971, 8201082, 8201083, 22436640, 22436651, 61003782, 61003783	—	—	—
IN3179	12V, Diamond Power 105P55	12	348°	CW	No	International MaxxForce® 11, 13, N13, A26 2007 - Current	8200433, 8200606, 8200802, 8200817, 8200857	LNMI05602, M105602, M110610	—	REN3933
FL3778	12V, Diamond Power 105P55	12	334°	CW	No	Freightliner with Cummins ISX12-G, Dual Relay System Only	—	—	—	—
IN3978	12V, Diamond Power 105P55	12	348°	CW	No	Cummins ISL with RPTO	—	—	—	—
MK0077	12V, Diamond Power 105P55	11	0°	CW	No	Mack with Mack E-7 ASET 1998 - 2006	8200037, 8200288, 8200289, 8200308, 8300020, 19011500, 19011505, 19011531	M110R2603SE, M110R2603SE2D, M110R2603SE-2D, M125601, M110603	—	REN3908
VV0279	12V, Diamond Power 105P55	12	25°	CW	No	Volvo with Volvo D12 1998 - 2006	8200058, 8200186, 8200291, 8300004, 19011515	M110605	—	REN3933
FL0579	12V, Diamond Power 105P55	11	0°	CW	No	Freightliner, Sterling, Western Star with Detroit Diesel® S60® 1998 - 2010; CAT C10, C12, C15 1998 - 2003; CAT C11, C13, C15 ACERT™ 2004 - 2006; Cummins ISX, ISM, N14 1998 - 2002	1990352, 1990355, 1990406, 1990484, 1990489, 1990490, 8200122, 8200163, 8200289, 8200308, 8300001, 8300002, 8300032, 10461052, 10461053, 10461055, 10461075, 10461233, 10461096	M110R2603SE, M110R2603SE2D, M110R2603SE-2D, M110R2615SE2D, M125601, M421052, M421055, M110603	FLTST4200, FLTST4201	REN3908
PC0079	12V, Diamond Power 105P60, DPS60	12	318°	CW	No	Kenworth and Peterbilt with PACCAR MX 11, MX13 2010 - Current	8200977, 8201084, 8201115	M110608	—	—
FLA579	12V, Diamond Power 105P60, DPS60	11	23°	CW	No	Freightliner and Western Star with Detroit Diesel® DD13®, DD15®, DD16® 2016 - Current	8201004, 61000704, 61002714, 61008898, 61011316	M110613, M110R2613SE	—	—



ROTATING ELECTRICAL (CONT'D)



MITSUBISHI NEW STARTERS (CONT'D)

PN	DESCRIPTION	PINION TEETH	SOLENOID POSITION	ROTATION	OVER-CRANK PROTECTION	APPLICATION	DELCO X-REF	LEECE-NEVILLE X-REF	FLEETRITE X-REF	TRP X-REF
FL0189	12V, Diamond Power 105P60, DPS60	12	23°	CW	No	Freightliner and Western Star with Detroit Diesel® DD13®, DD15®, DD16® Engines 2010 – 2015	8200329, 8200434, 8200671, 8201022, 8300084, 61000714, 61011315, DR 8200434, DR8200434, DR-8200434, 8200655	M39434, M110604	FLTST3901	RE3934, REN3934
VV0977	12V, Diamond Power 105P55	11	0°	CW	No	Volvo with Cummins ISX 2002 – 2006	1990424, 1990483, 8200289, 8200308	M110R2603SE, M110R2603SE2D, M110R2603SE-2D, M125601, M110603PRS, M110603	—	REN3908
FL0975	12V, Diamond Power 105P55	11	0°	CW	No	Freightliner and Western Star with Cummins ISX, ISM, N14 2003 – Current; All CAT HD Engines 2007 – 2010	8200090, 8200091, 8200289, 8200308, 8200661, 8200662, 8200686, 8200693, 8300009, 10461777, 19011519, 19011521, 61000945, 61003201	M110R2603SE, M110R2603SE2D, M110R2603SE-2D, M110R2615SE2D, M125601, M110603, M110603PRS	—	REN3908
FL0777	12V, Diamond Power 105P55	11	0°	CW	No	Freightliner, Western Star and Sterling with Detroit Diesel® S60® Engines 2007 – 2010	8200091, 8200289, 8200308, 8200623, 8200627, 8200628, 8200692, 8300019, 10461753, 19011516, 19011518, 19011529, 19011530, 8300019RMAN	M110615, M110R2603SE, M110R2603SE2D, M110R2603SE-2D, M110R2615SE2D, M125601, M110603, M110603PRS	—	REN3908
MK1078	12V, Diamond Power 105P55	11	36°	CW	No	Mack with Mack MP7 2005 – 2006	8200468, 22398213	—	—	—
FL1179	12V, Diamond Power 105P55	12	97°	CW	No	Freightliner, Western Star, Sterling with Mercedes-Benz 4000 2001 – 2010	8200082, 8200084, 8200287, 8200434, 8200624, 8200660, 8200687, 8200690, 8300008, 8300013, 8300037, 10461773, 10479282, 19011514, 19011525	M110601, M110604	—	REN3934
PC0979	12V, Diamond Power 105P55	11	0°	CW	No	Peterbilt with CAT C15, C15 ACERT™ 1998 – 2006	8200290, 8200308, 8200742	EDN-S907, M110R2603SE, M110R2603SE2D, M110R2615SE2D, M125601, M125R2001SEP, M110603	FLTST3900	REN3908, REN4252
PV2479	24V, Diamond Power 105P70	11	327°	CW	No	Prevost Bus with Detroit Diesel® S60® 1998 – 2009	8200314, 8200330, 1990418, 10461068	M105702	—	—
PV83379	24V, Diamond Power 105P70	12	215°	CW	No	Prevost Bus with Volvo D13, with Relay, 2007 – 2009	8200436	—	—	—
PC83579	24V, Diamond Power 105P70	11	0°	CW	No	Kenworth with CAT C13, C15, Cummins ISX-K500, 2008 – Current	8200314, 8200330, 10478998, 1990418, 10461068	M110615	—	—
PV84379	24V, Diamond Power 105P70	12	327°	CW	No	Prevost Bus with Volvo D13 without Relay, 2010 – Current	8200436	—	—	—
AM85371	24V, Diamond Power 105P70	11	0°	CW	No	Setra and Evobus with Mercedes-Benz Engine	—	—	—	—
MC2378	24V, Diamond Power 105P70	11	0°	CW	No	MCI Coach with Detroit Diesel® S60® 1998 – Current; CAT C12 1998 – 2003; CAT C13 ACERT™ 2004 – 2010; Cummins ISM 2007 – Current	8200314, 8200330, 10478998, 1990418, 10461068	—	—	—
AM84479	24V, Diamond Power 105P70	11	339°	CW	No	MCI Motorcoach with Cummins ISX 11.9L 2010 – Current	8200314, 8200330, 10478998, 1990418, 10461068	—	—	—
AM84579	24V, Diamond Power 105P70	12	338°	CW	No	MCI Motorcoach with Cummins ISL 2010 – Current	8200435, 10461031	—	—	—
AM85679	24V, Diamond Power 105P70	12	3°	CW	No	MCI Motorcoach with Detroit Diesel® 13L Engine 2012 – 2015	8200436	—	—	—
AM88279	24V, Diamond Power 105P70	11	28°	CW	No	MCI with Cummins X12 2019 – Current	—	—	—	—
AM86979	24V, Diamond Power 105P70	11	0°	CW	No	MCI Motorcoach with Detroit Diesel® 13L Engine 2016 – Current	8200436	—	—	—

Before Replacing the Starter

Check the state of charge of the batteries. They should be greater than 12.4V. Test cables from the battery box to the starter by measuring voltage drop. Voltage drop is measured by applying a 500A load at starter while measuring voltage at starter and at batteries. Voltage difference between the readings should be less than 0.5V (equivalent to 1 mΩ).

diamond-gard.com



ROTATING ELECTRICAL (CONT'D)



LEECE-NEVILLE NEW STARTERS

PN	DESCRIPTION	PINION TEETH	SOLENOID POSITION	ROTATION	OVER-CRANK PROTECTION	APPLICATION	DELCO X-REF	FLEETRITE X-REF	MITSUBISHI X-REF
M105602	12V	12	82	CW	No	M105 gear reduced starter with rotating nose. SAE3 Flange, for Cummins ISC, ISL; International DT466E, DT530, DT570, MaxxForce® DT9, DT10; CAT 3208	10461005, 10461501, 19011517, 1993887, 8200042, 10461008, 10461757, 19026028, 1993928, 8200058, 10461009, 10461769, 19026029, 1993931, 8200080, 10461012, 10478818, 1990316, 1993958, 8200087, 10461066, 10478926, 1990319, 1993969, 8200107, 10461169, 10478999, 1990379, 1993992, 8200186, 10461171, 10479034, 1990405, 8200218, 10461216, 10479060, 199310, 8200360, 10461227, 10479106, 1993745, 8200625, 10461240, 10479109, 1993763, 8300005, 10461265, 10479174, 1993770, 8300015	—	IN1378, M009T71378ZX, MITIN1378,
M105610	12V	10	319	CW	No	M105 gear reduced starter with rotating nose. Fits Cummins ISB 2007 Engines	10461771, 19026031, 8200023, 8200077, 8300024	—	—
M105611	12V	10	128	CW	No	M105 gear reduced starter with rotating nose. Fits CAT 3116, 3126, C7; Cummins M11, N14; Perkins 4-248, 6-354 Engines	10461003, 10461039, 10461081, 10461082, 10461094, 10461098, 10461110, 10461152, 10461197, 10461205, 10461207, 10461209, 10461210, 10461220, 10461225, 10461298, 10461416, 10478806, 10478831, 10478928, 10478929, 10478930, 10478953, 10478957, 10479015, 10479016, 10479036, 10479047, 10479069, 10479068, 10479107, 10479169, 10479195, 10479305, 1113102, 1113139, 1113164, 1113193, 113203, 113215, 113232, 113391, 113402, 113420, 113421, 113428	FLTST3806	—
M105612	12V	12	128	CW	No	M105 gear reduced starter with rotating nose. Fits CAT 3116, 3126, C7; John Deere 544G, 624G, 643G, 644G, 843G Engines	10461007, 10479071, 1113424, 1990320, 1993791, 10461456, 10479098, 1113444, 1990321, 1993883, 10478805, 10479207, 1113494, 1990327, 1993885, 10478825, 10479278, 1113495, 1993709, 1993891, 10478927, 1113195, 1113639, 1993728, 1993965, 10478949, 1113234, 1113660, 1993764, 8200055, 10479014, 1113235, 1113695, 1993768	—	—
M105613	12V with OCP	12	82	CW	Yes	M105 gear reduced starter with rotating nose. SAE3 Flange, fits Cummins ISC, ISL; International DT466E, DT530, DT570; MaxxForce® DT9, DT10; CAT 3208	10461063, 10461384, 19011526, 8200081, 8200659, 10461233, 10478812, 1990406, 8200219, 8300007, 10461304, 10479131, 1993997, 8200252, 8300074	—	—
M110603	12V with OCP	11	82.5	CW	Yes	M105 gear reduced starter with rotating nose. Fits Cummins ISX, ISM, N14, CAT C12, C13, C15; Detroit Diesel® S60®, 11L, 12.7L, 14L Engines	10461028, 10461183, 10479082, 1990428, 10461055, 10461185, 10479161, 1990489, 10461062, 10461232, 1990355, 1993776, 10461075, 10479030, 1990391, 8200289, 10461096, 10479038, 1990393, 8200308, 10461165, 10479062, 1990421, 8300009	FLTST3907	20851006, M009T70979, PB0979, D61-6002-004, M970979, PC0779, D61-6002-008, M983579, PC0979, FL0579, MIB970777, PC1479, FL0777, MIB970777FL, PC1879, FL0975, MIB970975, VV0776, IN1478, MIB970975FL, VV0977
M110604	12V with OCP	12	52.5	CW	Yes	M105 gear reduced starter with rotating nose. Fits MBE4000 Engines, DD13®, DD15®	19011525, 8200287, 8300008, 8200082, 8200434	FLTST3908	FL1179, MIB971179, MIB970379, MIB971179FL
M110605	12V with OCP	12	82.5	CW	Yes	M105 gear reduced starter with rotating nose. Fits Mack MP8 and Volvo D12 and D13 Engines	8200252 8300074	—	M9T70379, 20520903, 85103338, VV0279
M110610	12V with OCP	12	292.5	CW	Yes	M105 gear reduced starter with rotating nose. Fits International MaxxForce® 11 and 13 liter Engines	8200433	FLTST3906	M009T73179ZX, 9T73179ZX, IN3179
M110613	12V with OCP	11	292.5	CW	Yes	M105 Gear Reduced Starter with Rotating Nose. Fits DD13®, DD15® 2016 - Current	61000704, 8201004	—	FLA579, MIB9TA0579FL
M95301H	12V	12	82.5	CW	No	Cummins ISC, ISL; International DT466E, DT530E, DT570E; MaxxForce® DT9, DT10	1990319, 8300065, 10461005, 10461169, 10461171, 10461277, 10461385, 10461386, 10461769, 10478999, 10479034, 10479106, 10479250, 10479300, 19026028, 19026029, 1993794, 1993865, 1993874, 1993928, 1993969, 8200005, 8200025, 8200107, 8200211, 8200217, 8200374, 8200836, 8200958, 8300005	FLTST3807	M009T71378ZX, MITIN1378
M95303H	12V	10	322.5	CW	No	Cummins ISB	8200023, 8200077, 8200196, 8200235, 8200375, 8200571, 8200834, 8300024, 8300066, 19026031, 61005266, 61006210, 61006211	—	IN0971



ROTATING ELECTRICAL (CONT'D)



STARTERS BY MAKE/MODEL

OEM	ENGINE	MODEL YEAR	FLEETRITE X-REF	DELCO X-REF	LEECE-NEVILLE X-REF	MITSUBISHI X-REF	TRP X-REF	WAI X-REF
Freightliner, Sterling, Western Star	Detroit Diesel® Series 60®	1998 – 2006	FLTST4200	8200289, 8200308	M125601	FL0579	REN4255	6356N
Freightliner, Sterling, Western Star	CAT C10, C12, C15	1998 – 2003	FLTST4200	8200289, 8200308	M125601	FL0579	REN4255	6356N
Freightliner, Sterling, Western Star	CAT C11, C13, C15 ACERT™	2004 – 2006	FLTST4200	8200289, 8200308	M125601	FL0579	REN4255	6356N
Freightliner, Sterling, Western Star	Cummins ISX, ISM, N14	1998 – 2002	FLTST4200	8200289, 8200308	M125601	FL0579	REN4255	6356N
Freightliner, Sterling, Western Star	DD13®, DD15®, DD16®	2010 – 2015	FLTST3901	61000714, 8200434	M39434	FL0189	REN3934	6919N
Freightliner, Sterling, Western Star	DD13®, DD15®, DD16®	2016 – Current	—	61008898	M110613	FLA579	—	—
International	Cummins ISX, ISM, N14, M11	1998 – Current	FLTST3907	8200289, 8200308	LN125601	IN1478	REN3908	—
International	CAT C12, C15	1998 – 2003	FLTST3907	8200289, 8200308	LN125601	IN1478	REN3908	—
International	CAT C13, C15 ACERT™	2004 – 2009	FLTST3907	8200289, 8200308	LN125601	IN1478	REN3908	—
International	International MaxxForce® 15	ALL	FLTST3907	8200289, 8200308	LN125601	IN1478	REN3908	—
International	International DT466, DT530, HT570	1998 – Current	FLTST3906	8200817, 8200433	M105602	IN1378	—	—
International	International MaxxForce® DT9, DT10, N9, N10	1998 – Current	FLTST3906	8200817, 8200433	M105602	IN1378	—	—
International	Cummins ISL	2014 – Current	FLTST3906	8200817, 8200433	M105602	IN1378	—	—
International	International MaxxForce® 11, 13, N13, A26	2007 – Current	FLTST3807	8200817, 8200433	LN105602	IN3179	—	—
Kenworth	CAT C15, C15 ACERT™	1998 – 2006	FLTST3806	8200308	M125601	PC1479	—	—
Kenworth and Peterbilt	CAT C9, C10, C12	1998 – 2003	FLTST3806	8200290, 8200308	M125601	PC1479	—	—
Kenworth and Peterbilt	CAT C11 ACERT™	2004 – 2006	FLTST3806	8200290, 8200308	M125601	PC1479	—	—
Kenworth and Peterbilt	CAT C9, C13 ACERT™	2004 – Current	FLTST3806	8200290, 8200308	M125601	PC1479	—	—
Kenworth and Peterbilt	CAT C15, C15 ACERT™	2007 – 2010	FLTST3806	8200290, 8200308	M125601	PC1479	—	—
Kenworth and Peterbilt	Cummins ISX, ISM, N14	1998 – Current	FLTST3806	8200290, 8200308	M125601	PC1479	—	—
Volvo	Cummins ISX	2002 – 2006	FLTST3806	8200289, 8200308	M125602	VV0977	—	—
Volvo	Cummins ISX	2007 – Current	FLTST3806	8200289, 8200308	M125601	VV0776	—	—
Volvo	Volvo D16	2007 – Current	FLTST3806	8200469	—	VV1979	—	—

FLEETRITE STARTERS

PN	DESCRIPTION	PINION TEETH	SOLENOID POSITION	ROTATION	OVER-CRANK PROTECTION	DELCO X-REF	LEECE-NEVILLE X-REF	UNIPOINT X-REF	WILSON X-REF
FLTST3907	Motor with Solenoid, R	11	82	CW	Yes	10461147, 10461777, 19011500, 19011505, 19011516, 19011518, 19011521, 19011529, 19011531, 8200031, 8200033, 8200037, 8200038, 8200040, 8200050, 8200083, 8200088, 8200090, 8200091, 8200104, 8200288, 8200289, 8200290, 8200308, 8200428, 8200623, 8200628, 8200647, 8200661, 8200662, 8200692, 8200693, 8300002, 8300019	M110603	STR-0121	91-01-4622, 91-01-4622N
FLTST3906	39 12V 12T, OCP IM	12	82	CW	Yes	10461757, 10461760, 19011510, 19011513, 19011515, 19011517, 19011526, 8200028, 8200030, 8200045, 8200058, 8200081, 8200085, 8200087, 8200182, 8200186, 8200218, 8200219, 8200291, 8200360, 8200433, 8200469, 8300061	M110610	STR-4294, STR-4295	91-01-4632, 91-01-4760N
FLTST3808	38 12VT, 10T	10	82	CW	No	8200007, 8300022	M105617	STR-0122	91-01-4626, 91-01-4626N
FLTST4202	42 12VT, 11T	11	82	CW	No	10461033, 10461038, 10461052, 10461053, 10461533, 10478809, 10478832, 10478833, 10478894, 10478951, 10478963, 10478987, 10479110, 10479112, 10479113, 10479116, 10479185, 10479285, 1109820, 1114034, 1114049, 1990337, 1990348, 1990352, 1990354, 1990358, 1990363, 1990375, 1990376, 1990386, 1990398, 1990400, 1990420, 1990423, 1990424, 1990450, 1990465, 1990468, 1990470, 1990475, 1990476, 1990477, 1990478, 1990483, 1990495, 1993803, 1993807, 1993816, 1993823, 1993932, 1993934, 1993975, 1993977, 1993982, 1993985, 323-743, 323-821, 323-867, 35000VL, 63253VL, 63254VL	—	STR-4200, STR-4204	91-01-4151, 91-01-4151N, 91-01-4166, 91-01-4166N, 91-01-4422, 91-01-4425
FLTST3807	38 12VT, 12T	12	82	CW	No	10461769, 19026028, 19026029, 8200005, 8200025, 8200211, 8200217, 8300005, 8300065	—	STR-0121	91-01-4622, 91-01-4622N



BATTERIES



STARTING BATTERIES

BCI GROUP	COLD CRANKING AMPS	RESERVE CAPACITY	TERMINAL TYPE	FLEETRITE TIER LEVEL	FLEETRITE WARRANTY	FLEETRITE X-REF	TRP/PACCAR GENUINE X-REF	EAST PENN/ALLIANCE X-REF
31	1000	185	Stud	Gold	24 month	FEP1231MF	BT3IS111EXCH, P27-6100-212EXCH	1231MFD, ABP AE1131XMF
31	660	160	Post	Gold	24 month	FLTBT31650S	BT3IS61EXCH	931MF, ABP AE931MF
31	660	160	Post	Silver	18 month	FLTBT31650	BT3IS61EXCH	931MF, ABP AE931MF
31	660	160	Post	Gold	24 month	FLTBTG31660	BT3IS61EXCH	931MF, ABP AE931MF
31	750	180	Stud	Gold	24 month	FLTBT31650A	BT3IP61EXCH	931PMF, ABP AE931PMF
31	750	180	Post	Gold	24 month	FLTBT31750S	BT3IS72EXCH	1031MF, ABP AE1031MF
31	750	180	Post	Gold	24 month	FLTBTG31750	BT3IS72EXCH	1031MF, ABP AE1031MF
31	750	180	Post	Silver	18 month	FEP1031MF	BT3IS72EXCH	1031MF, ABP AE1031MF
31	760	170	Post	Silver	18 month	FEP1031PMF	BT3IP71EXCH, P27-6100-111EXCH	ABP AE1031PMF
31	925	190	Post	Gold	24 month	FLTBT31925S	BT3IS95	ABP A31P925VL
31	925	190	Post	Silver	18 month	FLTBT31925	BT3IS95	ABP A31P925VL
31	925	190	Post	Silver	18 month	FLTBT31XHHD	BT3IS95	ABP A31P925VL
31	950	195	Stud	Gold	24 month	FLTBT31925A	—	ABP A31S925VL
31	950	195	Post	Gold	24 month	FLTBTG31950	BT3IS91EXCH	1131MF, ABP AE1131MF
31	950	175	Stud	Silver	18 month	FEP1131MF	BT3IS91EXCH	1131MF, ABP AE1131MF
31	1000	195	Stud	Gold	24 month	FLTBTG31P	BT3IP91EXCH	1131PFM, ABP AE1131PMF
31	950	175	Post	Silver	18 month	FEP1131PMF	BT3IP91EXCH	1131PFM, ABP AE1131PMF
4D	1000	295	Post	Silver	18 month	FLTBTG4D	BT4DP101EXCH	904D, ABP A904D
4D	1000	295	Post	Silver	18 month	FEP904D	BT4DP101EXCH	904D, ABP A904D
8D	1400	450	Post	Silver	18 month	FLTBTG8D	BT8DP143EXCH	908D, ABP A908DFT
8D	1400	450	Post	Silver	18 month	FEP908D	BT8DP143EXCH	908D, ABP A908DFT



DUAL PURPOSE BATTERIES

BCI GROUP	COLD CRANKING AMPS	RESERVE CAPACITY	TERMINAL TYPE	FLEETRITE TIER LEVEL	FLEETRITE WARRANTY	FLEETRITE X-REF	FREEDOM HEAVY DUTY X-REF	TRP/PACCAR GENUINE X-REF
31	700	185	Stud	Silver	18 month	FEPDP31PCS	31T-EXTREME	BD31S71EXCH
31	700	190	Stud	Gold	24 month	FLTBTG31700	31T-EXTREME	BD31S71EXCH
31	700	190	Stud	Gold	24 month	FLTBT31700SHC	31T-EXTREME	BD31S71EXCH
31	730	190	Stud	Gold	24 month	FEP7T31	31T-EXTREME	BD31S71EXCH



PLATINUM HEAVY DUTY AGM

BCI GROUP	COLD CRANKING AMPS	RESERVE CAPACITY	TERMINAL TYPE	FLEETRITE TIER LEVEL	FLEETRITE WARRANTY	FLEETRITE X-REF	FREEDOM HEAVY DUTY X-REF	TRP/PACCAR GENUINE X-REF
31	700	200	Stud	Gold	24 month	FLBTBTRF31D	—	—
31	825	200	Stud	Platinum	36 month	FLBTBP31825	31T-AGM	BAF31S91EXCH
31	925	190	Stud	Gold	24 month	FEP9F31	—	—



PLATINUM PURE LEAD AGM

BCI GROUP	COLD CRANKING AMPS	RESERVE CAPACITY	TERMINAL TYPE	FLEETRITE TIER LEVEL	FLEETRITE WARRANTY	FLEETRITE X-REF	OPTIMA X-REF	TRP/PACCAR GENUINE X-REF
31	900	155	Stud	—	—	—	31T-OPTIMA	YEL31STUD, BAF31S91EXCH
31	925	200	Stud	Super Platinum	48 month	FLT31925	—	ODP-AGM31
31	1150	205	Stud	Super Platinum	48 month	FLT312150	—	ODX-AGM31
31	1150	205	Stud	Super Platinum	48 month	FLTNSB31	—	ODX-AGM31



AUTOMOTIVE

BCI GROUP	COLD CRANKING AMPS	RESERVE CAPACITY	TERMINAL TYPE	FLEETRITE TIER LEVEL	FLEETRITE WARRANTY	FLEETRITE X-REF	FREEDOM AUTOMOTIVE X-REF	TRP/PACCAR GENUINE X-REF
65	850	115	SAE	—	—	FEP665MF	65-850	BT65P81EXCH
65	750	—	SAE	—	—	FEP765MF	65-750	BT65P71EXCH
78	800	110	Side Post	—	—	ER78800	78-800	BT78P81EXCH
78	800	110	Side Post	—	—	ER78DT800	78-800	BT78P81EXCH



CABLE, WIRE, CONNECTORS AND RELATED PARTS



CABLE ASSEMBLIES

PN	DESCRIPTION	PHILLIPS X-REF	FLEETRITE X-REF	TECTRAN X-REF	TRAMEC SLOAN X-REF
PHL30217429	15' QWIK-CHANGE™ PAK Power Air Kit	30-217429	—	—	—
PHL30215429	12' QWIK-CHANGE™ PAK Power Air Kit	30-215429	—	—	—
PHL302174	Electrical/Air Assembly, 3-in-1, 15', ABS, QCP™ (Quick-Change Plug), Red and Blue Rubber Air Lines	30-2174	—	—	—
PHL302154	Electrical/Air Assembly, 3-in-1, 12', ABS, QCP™ (Quick-Change Plug), Red and Blue Rubber Air Lines	30-2154	—	—	—
PHL302171	Electrical/Air Assembly, 3-in-1, 15', ABS, Zinc Die-Cast Plugs, Red and Blue Rubber Air Lines	30-2171	FLTC3171	169157	451098
PHL302151	Electrical/Air Assembly, 3-in-1, 12', ABS, Zinc Die-Cast Plugs, Red and Blue Rubber Air Lines	30-2151	FLTC3151	169127	451097
PHL115150	Air Brake Coil, POLAR AIR®, 15', Red and Blue (Emergency and Service), Set	11-5150	—	17A15H	451036
PHL115400	Air Brake Coil, POLAR AIR®, 15', 40" Lead, Red and Blue (Emergency and Service), Set	11-5400	—	17A15-40H	451039
PHL11315	Air Brake Coil, Heavy-Duty, 15', Red and Blue (Emergency and Service), Set	11-315	—	17215.00	55101
PHL11340	Air Brake Coil, Heavy-Duty, 15', 40" Lead, Red and Blue (Emergency and Service), Set	11-340	—	17215-040	55103
PHL1181150	Air Line, Red and Blue Rubber, 15', Red and Blue (Emergency and Service) Handles, Set	11-81150	FLTCE1181150	—	—
PHL1181150	Air Line, Black Rubber, 15', Red and Blue (Emergency and Service) Handles, Set	11-8115	FLTCE118115	17915H	—
PHL1181108	Air Line, Red Rubber, 12', Red/Emergency Handle	11-81108	FLTCE1181108	—	—
PHL1181178	Air Line, Red Rubber, 15', Red/Emergency Handle	11-81178	FLTCE1181178	—	—
PHL302074	Cable Assembly, ABS LECTRAFLEX™, Straight, 15', 4/12, 2/10, 1/8 Gauge, with QCP™ (Quick-Change Plugs)	30-2074	—	—	—
PHL302070	Cable Assembly, ABS LECTRAFLEX™, Straight, 15', 4/12, 2/10, 1/8 Gauge, with WEATHER-TITE™ PERMAPLUGS™	30-2070	—	7AAB152MW	421200
PHL302071	Cable Assembly, ABS LECTRAFLEX™, Straight, 15', 4/12, 2/10, 1/8 Gauge, Zinc Die-Cast Plugs	30-2071	FLTCE071	7AAB152MG	4BA15
PHL244621	Cable Assembly, NON-ABS PERMACOIL™, Coiled, 15', 6/14, 1/12 Gauge, with Zinc Die-Cast Plugs	24-4621	FLTCE244621	7ETB522MG	421113
PHL224621	Cable Assembly, NON-ABS PERMACOIL™, Coiled, 15', 6/12, 1/10 Gauge, Zinc Die-Cast Plugs	22-4621	FLTCE621	7STS522MG	421115
PHL304621	Cable Assembly, ABS PERMACOIL™, Coiled, 15', 4/12, 2/10, 1/8 Gauge, Zinc Die-Cast Plugs	30-4621	—	7ATG522MG	4AA15
PHL304921	Cable Assembly, ABS PERMACOIL™, Coiled, 15', 48" Lead, 4/12, 2/10, 1/8 Gauge, Zinc Die-Cast Plugs	30-4921	FLTCE921	7ATG542MG	4AA17
PHL304321	Cable Assembly, ABS PERMACOIL™, Coiled, 12', 4/12, 2/10, 1/8 Gauge, Zinc Die-Cast Plugs	30-4321	—	7ATG222MG	4AA12
PHL304624	Cable Assembly, ABS PERMACOIL™, Coiled, 15', 4/12, 2/10, 1/8 Gauge, QCP™ (Quick-Change Plugs)	30-4624	—	—	—
PHL309621	Cable Assembly, ABS LECTRACOIL™, Coiled, 15', 4/12, 2/10, 1/8 Gauge, Zinc Die-Cast Plugs	30-9621	—	—	—
PHL309920	Cable Assembly, ABS LECTRACOIL™, Coiled, 15', 48" Lead, 4/12, 2/10, 1/8 Gauge, WEATHER-TITE™ PERMAPLUGS™	30-9920	—	—	—



BATTERY CABLE, HARDWARE AND ACCESSORIES

PN	DESCRIPTION	PHILLIPS X-REF	TECTRAN X-REF	TRAMEC SLOAN X-REF
PHL3511	Battery Cable, 2/0 Gauge, Red, 25', Spool	3-511	702/OA5-Q	422261
PHL3512	Battery Cable, 2/0 Gauge, Black, 25', Spool	3-512	702/OA1-Q	422264
PHL3516	Battery Cable, 4/0 Gauge, Black, 25', Spool	3-516	704/OA1-Q	422269
PHL3518	Booster Cable, 2/4 Gauge, Dual Color, Yellow and Black, 100', Spool	3-518	—	422503
PHL3524	Booster Cable, 2/4 Gauge, Dual Color, Red and Black, 100', Spool	3-524	7204A-1	—
PHL3523	Booster Cable, 2/6 Gauge, Dual Color, Orange and Black, 100', Spool	3-523	7206A-1	—
PHL8662	Battery Hardware, Nut, Closed Cap, 3/8", 16, Polybag	8-662	5019-S	422126



QCP™ PAK – Complete Back-of-Cab Connection System

The Phillips QCP PAK (Power Air Kit) is a fleet's complete turnkey Back-of-Cab Air/Electric Connection System. This all-in-one kit includes Phillips' patented Quick-Change Plug (QCP™), factory-installed anodized gladhands on the 3-in-1, and two heavy-duty QWIK-CHANGE™ Tracker Spring Kits with QWIK-CLAMP™. When installed properly, the PAK delivers significant cost savings to a fleet and represents the best opportunity to last the full life cycle of the truck. Packaged within a pristine retail box that makes it ideal within a front parts area, the PAK has quickly become the #1 moving SKU for Phillips Industries!

Email PhillipsPAKConsult@phillipsind.com to learn more about our Back-of-Cab Connection System.

phillipsind.com



CABLE, WIRE, CONNECTORS AND RELATED PARTS (CONT'D)



ELECTRICAL CONNECTORS

PN	DESCRIPTION	PHILLIPS X-REF	FLEETRITE X-REF	TECTRAN X-REF	TRAMEC SLOAN X-REF
PHL15720	Socket, 7-Pin, Split Pin, 2-Hole Mount, Zinc Die-Cast	15-720	FLTCS720	670-72	38497
PHL15730	Plug, 7-Pin, with Cable Guard, Zinc Die-Cast	15-730	FLCS701	670-71SG	38197
PHL15762	Socketbreaker, Zinc Die-Cast, 7-Pin, Ext. Barrel, with 20A Circuit Breakers, Split Pin	15-762	—	670-7220	38813
PHL15760	Socketbreaker, Zinc Die-Cast, 7-Pin, Ext. Barrel, without Circuit Breakers, Split Pin	15-760	—	670-7200	38801
PHL15763	Socketbreaker, Zinc Die-Cast, 7-Pin, Ext. Barrel, with 30A Circuit Breakers, Split Pin	15-763	—	670-7230	38815
PHL15042	Plug and Gladhand Bracket, STOW-A-WAY™, Two Plug and Two Gladhand Holder	15-042	—	9409-2	441748
PHL15961	Junction Box, 7-Pole, for Ring Terminal, Clear	15-961	—	667-7090	421246
PHL15326	Socket, Dual Pole, Zinc Die-Cast	15-326	—	670-22	421171
PHL15336	Plug, Dual Pole, with Cable Guard, Zinc Die-Cast	15-336	—	670-21SG	421170
PHL16724	Socket, 7-Pin, Bullet Terminal, Split Pin, 2-Hole Mount	16-724	—	670-75	38298
PHL16775	Nosebox Kit, includes STA-DRY®, Single Cavity, Deep, Grommet and Back Plate	16-775	—	670P-7207	3826035
PHL16760228	Socketbreaker, STA-DRY®, Composite, 28-Pin, Solid Pins, without Circuit Breakers	16-7602-28	—	670-28A00	38304
PHL16726	Socket, 7-Pin, Bullet Terminal, Split Pin, QCS® (Quick-Change Socket) Locking Clip, 2-Hole Mount	16-726	—	670-75L	—
PHL16722	Socket, 7-Pin, Ring Terminal, Split Pin, 2-Hole Mount	16-722	—	670-74	38283
PHL16720	Socket, Waterproof, 7-Pin, Wire Insert, Split Pin, 2-Hole Mount	16-720	—	670P-72	38492
PHL16802	Document Holder, STA-DRY® with Tether	16-802	—	9446.00	422325
PHL1674031	QCS2® (Quick-Change Socket), Straight, 24" Lead Blunt Cut, 16-724 Socket, Green Jacket	16-74031	—	—	—
PHL16822	Socket, STA-DRY®, ISO 3731, Ring Termination	16-822	—	680P-74	38701
PHL16762228	Socketbreaker, STA-DRY®, Composite, 28-Pin, Solid Pins, with 20A Circuit Breakers	16-7622-28	—	—	—
PHL168510	Nosebox, QBOX™, without Circuit Breakers, 16-724 STA-DRY® Socket	16-8510	—	—	—
PHL16760228	Socketbreaker, STA-DRY®, Composite 7-Pin, without Circuit Breakers	16-760	—	670P-7200	38361
PHL16762	Socketbreaker, STA-DRY®, Composite 7-Pin, with 20A Circuit Breakers	16-762	—	670P-7220	38213
PHL1674031	QCS2® (Quick-Change Socket), Straight, 48" Lead Blunt Cut, 16-724 Socket, Green Jacket	16-7403	—	7167401.00	38403-04
PHL16770928	Socketbreaker, STA-DRY®, Composite, 28-Pin, Split Pins, without Circuit Breakers, with Single Nosebox	16-7709-28	—	—	38306
PHL16125	Plug Insert, QCP™ (Quick-Change Plug), Polybag	16-125	—	—	—



LIFTGATE CHARGING

PN	DESCRIPTION	PHILLIPS X-REF	FLEETRITE X-REF	TECTRAN X-REF	TRAMEC SLOAN X-REF
PHL2322776	Cable Assembly, WEATHER-TITE™ M2, Liftgate, Dual Pole, Straight, 15', 2/4 Gauge, with Molded Plug with WEATHER-TITE™ Seal	23-22776	—	—	—
PHL232326	Cable Assembly, Liftgate, Dual Pole, Coiled, 12', 2/4 Gauge, with Zinc Die-Cast Plugs	23-2326	—	—	421172
PHL232626	Cable Assembly, Liftgate, Dual Pole, Coiled, 15', 2/4 Gauge, with Zinc Die-Cast Plugs	23-2626	—	—	421173
PHL2326276	Cable Assembly, WEATHER-TITE™ M2, Liftgate, Dual Pole, Coiled, 15', 2/4 Gauge, with Molded Plug with WEATHER-TITE™ Seal	23-26276	—	—	—
PHL232628	Cable Assembly, Liftgate, Dual Pole to Single Pole, Coiled, 15', 2/4 Gauge, with Zinc Die-Cast Plugs	23-2628	—	7DTB522XW	—
PHL232630	Cable Assembly, Liftgate, Dual Pole "Y" Adapter, Coiled, 15', 2/4 Gauge, with Zinc Die-Cast Plugs	23-2630	—	—	—
PHL2329276	Cable Assembly, WEATHER-TITE™ M2, Liftgate, Dual Pole, Coiled, 15' with a 48" Lead, 2/4 Gauge, with Molded Plug with WEATHER-TITE™ Seal	23-29276	—	—	—
PHL234325	Cable Assembly, Liftgate, Single Pole, Coiled, 12', 4 Gauge, with Zinc Die-Cast Plugs	23-4325	—	7BTG222MG	38181-12
PHL234625	Cable Assembly, Liftgate, Single Pole, Coiled, 15', 4 Gauge, with Zinc Die-Cast Plugs	23-4625	FLTCE625	7BTG522MG	38181-15
PHL2322576	Cable Assembly, WEATHER-TITE™ M2, Liftgate, Dual Pole, Straight, 12', 2/4 Gauge, with Molded Plug with WEATHER-TITE™ Seal	23-22576	—	—	—
PHL2522576	Cable Assembly, WEATHER-TITE™ M2, Liftgate, Dual Pole, Straight, 12', 2/2 Gauge, with Molded Plug with WEATHER-TITE™ Seal	25-22576	—	—	—
PHL2329276	Cable Assembly, WEATHER-TITE™ M2, Liftgate, Dual Pole, Coiled, 15' with a 48" Lead, 2/4 Gauge, with Molded Plug with WEATHER-TITE™ Seal	23-29276	—	—	—
PHL2526276	Cable Assembly, WEATHER-TITE™ M2, Liftgate, Dual Pole, Coiled, 15', 2/2 Gauge, with Molded Plug with WEATHER-TITE™ Seal	25-26276	—	—	—
PHL162237	Kit, Dual Pole QCS2®, Straight Back Position, 2 Gauge, 48" Terminated Lead, with Socket (16-324), Bracket (15-791), 120A CB, and Three Cushion Clamps	16-2237	—	—	—
PHL162237096	Kit, Dual Pole QCS2®, Straight Back Position, 2 Gauge, 96" Terminated Lead, with Socket (16-324), Bracket (15-791), 120A CB, and Three Cushion Clamps	16-2237-096	—	—	—
PHL162423	Dual Pole QCS2®, 6 O'Clock Angled Position, 4 Gauge, 48" Blunt Cut Lead, with 16-324 Dual Pole QCS2® Socket	16-2423	—	—	—
PHL162233	Dual Pole QCS2®, Straight Back Position, 2 Gauge, 48" Blunt Cut Lead, with 16-324 Dual Pole QCS2® Socket	16-2233	—	—	—
PHL162433	Dual Pole QCS2®, Straight Back Position, 4 Gauge, 48" Blunt Cut Lead, with 16-324 Dual Pole QCS2® Socket	16-2433	—	—	—
PHL16324	Socket, Dual Pole QCS2®, Offset Solid Brass Pins, Bullet Termination, STA-DRY® Housing, for Use with Phillips Dual Pole QCS2® Boot, 2-Hole Mount	16-324	—	—	—



CABLE, WIRE, CONNECTORS AND RELATED PARTS (CONT'D)



TRAILER CABLE

PN	DESCRIPTION	PHILLIPS X-REF	TECTRAN X-REF	TRAMEC SLOAN X-REF
PHL3191	DURAFLEX™, 4 Conductor, 14 Gauge, 50', Spool	3-191	—	422215
PHL3192	DURAFLEX™, 4 Conductor, 14 Gauge, 100', Spool	3-192	—	422216
PHL3194	DURAFLEX™, 4 Conductor, 14 Gauge, 500', Spool	3-194	—	422218
PHL3221	DURAFLEX™, 7 Conductor, 6/12, 1/10 Gauge, 50', Spool	3-221	—	422230
PHL3222	DURAFLEX™, 7 Conductor, 6/12, 1/10 Gauge, 100', Spool	3-222	—	422231
PHL3223	DURAFLEX™, 7 Conductor, 6/12, 1/10 Gauge, 250', Spool	3-223	—	422232
PHL3224	DURAFLEX™, 7 Conductor, 6/12, 1/10 Gauge, 500', Spool	3-224	—	422233
PHL3241	DURAFLEX™, 7 Conductor, 6/14, 1/12 Gauge, 50', Spool	3-241	—	422225
PHL3242	DURAFLEX™, 7 Conductor, 6/14, 1/12 Gauge, 100', Spool	3-242	—	422226
PHL3243	DURAFLEX™, 7 Conductor, 6/14, 1/12 Gauge, 250', Spool	3-243	—	422227
PHL3244	DURAFLEX™, 7 Conductor, 6/14, 1/12 Gauge, 500', Spool	3-244	—	422228
PHL3245	DURAFLEX™, 7 Conductor, 6/14, 1/12 Gauge, 1000', Spool	3-245	—	422229
PHL3327	LECTRAFLEX™, 7 Conductor, 4/12, 2/10, 1/8 Gauge, Green, 100', Spool	3-327	—	OCT202301
PHL3328	LECTRAFLEX™, 7 Conductor, 4/12, 2/10, 1/8 Gauge, Green, 250', Spool	3-328	—	422312
PHL3329	LECTRAFLEX™, 7 Conductor, 4/12, 2/10, 1/8 Gauge, Green, 500', Spool	3-329	—	OCT202305
PHL3602	ARCTIC SUPERFLEX™, 4/14 Gauge, Dark Blue, -85°F/-65°C, 100', Spool	3-602	744A1	—
PHL3603	ARCTIC SUPERFLEX™, 4/14 Gauge, Dark Blue, -85°F/-65°C, 250', Spool	3-603	744A2	—
PHL3622	ARCTIC SUPERFLEX™, 6/14 and 1/12 Gauge, Dark Blue, -85°F/-65°C, 100', Spool	3-622	76412A1	—
PHL3623	ARCTIC SUPERFLEX™, 6/14 and 1/12 Gauge, Dark Blue, -85°F/-65°C, 250', Spool	3-623	76412A2	—
PHL3624	ARCTIC SUPERFLEX™, 6/14 and 1/12 Gauge, Dark Blue, -85°F/-65°C, 500', Spool	3-624	76412A5	—
PHL3633	ARCTIC SUPERFLEX™, 6/12 and 1/10 Gauge, Dark Blue, -85°F/-65°C, 250', Spool	3-633	76210A2	—
PHL3652	ARCTIC SUPERFLEX™, 2/14 Gauge, Dark Blue, -85°F/-65°C, 100', Spool	3-652	724A1	—
PHL3653	ARCTIC SUPERFLEX™, 2/14 Gauge, Dark Blue, -85°F/-65°C, 250', Spool	3-653	724A2	—
PHL3662	ARCTIC SUPERFLEX™, 3/14 Gauge, Dark Blue, -85°F/-65°C, 100', Spool	3-662	734A1	—
PHL3663	ARCTIC SUPERFLEX™, 3/14 Gauge, Dark Blue, -85°F/-65°C, 250', Spool	3-663	—	—



PRIMARY WIRE, CONNECTORS AND ACCESSORIES

PN	DESCRIPTION	PHILLIPS X-REF	TECTRAN X-REF	TRAMEC SLOAN X-REF
PHL2121	14 Gauge, Black, 100', Spool	2-121	714-01	422287
PHL2122	14 Gauge, Blue, 100', Spool	2-122	714-02	422288
PHL2123	14 Gauge, Brown, 100', Spool	2-123	714-03	422289
PHL2124	14 Gauge, Green, 100', Spool	2-124	714-04	422290
PHL2125	14 Gauge, Red, 100', Spool	2-125	714-05	422291
PHL2126	14 Gauge, White, 100', Spool	2-126	714-06	422292
PHL2127	14 Gauge, Yellow, 100', Spool	2-127	714-07	422293
PHL2131	12 Gauge, Black, 100', Spool	2-131	712-01	422294
PHL2132	12 Gauge, Blue, 100', Spool	2-132	712-02	422295
PHL2133	12 Gauge, Brown, 100', Spool	2-133	712-03	422296
PHL2134	12 Gauge, Green, 100', Spool	2-134	712-04	422297
PHL2135	12 Gauge, Red, 100', Spool	2-135	712-05	422298
PHL2136	12 Gauge, White, 100', Spool	2-136	712-06	422299
PHL2137	12 Gauge, Yellow, 100', Spool	2-137	712-07	422300
PHL2141	10 Gauge, Black, 100', Spool	2-141	710-01	422301
PHL2142	10 Gauge, Blue, 100', Spool	2-142	710-02	422302
PHL2144	10 Gauge, Green, 100', Spool	2-144	710-04	422304
PHL2145	10 Gauge, Red, 100', Spool	2-145	710-05	422305
PHL2146	10 Gauge, White, 100', Spool	2-146	710-06	422306
PHL2147	10 Gauge, Yellow, 100', Spool	2-147	710-07	422307
PHL2151	8 Gauge, Black, 100', Spool	2-151	708-01	422308
PHL2155	8 Gauge, Red, 100', Spool	2-155	708-05	422309
PHL2156	8 Gauge, White, 100', Spool	2-156	—	422493



CABLE, WIRE, CONNECTORS AND RELATED PARTS (CONT'D)



TIE STRAPS AND RELATED PARTS

PN	DESCRIPTION	PHILLIPS X-REF	FLEETRITE X-REF	TECTRAN X-REF	TRAMEC SLOAN X-REF
PHL170400	Pogo Stick, Bright Chrome, 40"	17-0400	—	9400G-2	34200
PHL170401	Pogo Stick, Gold Chromate, 40"	17-0401	—	9400E-2	34259
PHL17111	Tender Spring, 11"	17-111	—	911	34015
PHL17116	Tender Spring, 16"	17-116	—	913	34114
PHL17125	Tender Spring, 25" Heavy-Duty	17-125	—	910	34017
PHL17148	Tender Spring Assembly, 20" Heavy-Duty Spring, with PVC Sleeve and QWIK-SNAP™, 3-Hose Holder	17-148	—	9820-1	34056
PHL171481	Tender Spring Assembly, 20.5" Extra Heavy-Duty Spring, with PVC Sleeve and QWIK-CLAMP™ (17-180)	17-1481	—	—	—
PHL171482	Tender Spring Assembly, 25" Extra Heavy-Duty Spring, with PVC Sleeve and QWIK-CLAMP™ (17-180)	17-1482	—	—	—
PHL171488	Tender Spring Assembly, 20.5" Tender Spring, with PVC Sleeve and Cable Clamp Holder	17-1488	—	—	—
PHL17153	Hose Holder, QWIK-SNAP™ 3-Hose, Snap-On Clip, Polybag	17-153	—	9888	34213
PHL17157	Hose Holder, 3-Hose, U-Bolt, Polybag	17-157	—	94-0000	34213
PHL17161	Clip, Snap-On, Black Powder Coated with Wire Gate, 4", Polybag	17-161	—	—	—
PHL17180	Hose Holder, QWIK-CLAMP™ with Insert, for 3-in-1 Combination Assemblies (Clamp I.D. 1.60"), or 1 to 3 Individual Cables, Polybag	17-180	—	9890ST	451169
PHL17181	Hose Holder, QWIK-CLAMP™ without Insert, for 3-in-1 Combination Assemblies (Clamp I.D. 1.60"), Polybag	17-181	—	—	451218
PHL173000	Tracker Bar Extension, X-TEND®, 8" Extension Bar, Mounting Bracket Fits 3/4" Diameter Tracker Bar	17-3000	—	—	—
PHL17420	Tender Spring Assembly, Two 16" Tender Springs, with Two PVC Sleeves, with One 17-153 QWIK-SNAP™	17-420	—	9420-2	34060
PHL173001	Tracker Bar Extension, X-TEND®, 8" Extension Bar, Mounting Bracket Fits 1" Diameter Tracker Bar	17-3001	—	—	—
PHL173500	Tracker Bar Extension, X-TEND® Day Cab, 8" Extension Bar, Mounting Bracket Fits 3/4" Diameter Tracker Bar	17-3500	—	—	—
PHL173501	Tracker Bar Extension, X-TEND® Day Cab, 8" Extension Bar, Mounting Bracket Fits 1" Diameter Tracker Bar	17-3501	—	—	—
PHL12006	Gladhand, Service Standard Mount	12-006	FLTGH006	1011S	56101
PHL12008	Coupling Gladhand, Emergency Standard Mount	12-008	FLTGH008	1011E	56201
PHL12010	Gladhand, Universal Standard Mount	12-010	FLTGH010	1011	56301



Pulley Installation on Delco Remy 24SI™ or 28SI™

1. Set the alternator in the horizontal position on a flat surface. If the pulley is installed when the alternator is in the upright or vertical position, the pulley may not be fully seated. This will result in a loose stack-up and early alternator failure.
2. Remove the pulley nut and cardboard spacer, and then discard cardboard spacer. Pay special attention to the orientation of the bearing slinger and spacer washer. These items commonly slide off the rotor shaft during removal of the pulley nut and cardboard tub.
3. Before installing the pulley, make sure that the spacer washer is placed against the bearing and then the slinger is placed against the spacer washer. Failure to place these in the correct order will result in rotor lock-up and early alternator failure.
4. Slide the pulley in place by hand. Never use a hammer to force the pulley on shaft. This could result in pulley or bearing damage.
5. Take the pulley nut that was removed in Step 2 and use it to hand-tighten against the pulley. Never start the pulley nut with an impact wrench. This could result in pulley or bearing damage.
6. There are two different methods to tighten the pulley nut.
 - #1: Using pass-through socket 15/16, secure the pulley nut so it doesn't move. Using a torque wrench with a 5/16 hex head socket placed in the hexagonal hole at the end of the rotor shaft, tighten the rotor shaft counterclockwise to 95-108 N-m (70-80 lb. ft.).
 - #2: Hold the shaft by placing a 5/16 hex wrench in the hexagonal hole at the end of the rotor shaft. Use a clicktype torque wrench with an open-ended 15/16 wrench attached. Tighten the pulley nut to 95-108 N-m (70-80 lb. ft.).



delcoremy.com



A REVOLUTION IN FLEET MANAGEMENT

International® 360 is a ground-breaking service communication and fleet management platform that accelerates the repair process, streamlines communication, is easy to use, and drives greater uptime.

Visit InternationalTrucks.com/360





GENUINE CUMMINS PARTS

Genuine Cummins Parts are backed by more than 100 years of engineering experience. We've made significant investments in research, design and testing to ensure peak performance of our engines and unmatched quality of our parts.

Cummins Engineers conducted lab analysis and destructive testing on over 300 non-genuine overhaul kit components for ISX and N14 engines, including pistons, piston rings, piston pins, cylinder liners, main bearings, connecting rod bearings, head gaskets and injectors.

Of the over 300 non-genuine parts tested, none met all of Cummins Design Specifications.

THERE IS A DIFFERENCE.

Learn more:
www.cummins.com/parts/why-buy-genuine



SECURITY ON THE ROAD.

RENEWED™ engine components cost significantly less than new and offer greater reliability with re-engineered knowledge powering each component.

RE-ENGINEER YOUR UPTIME

fleetrite.com/renewed

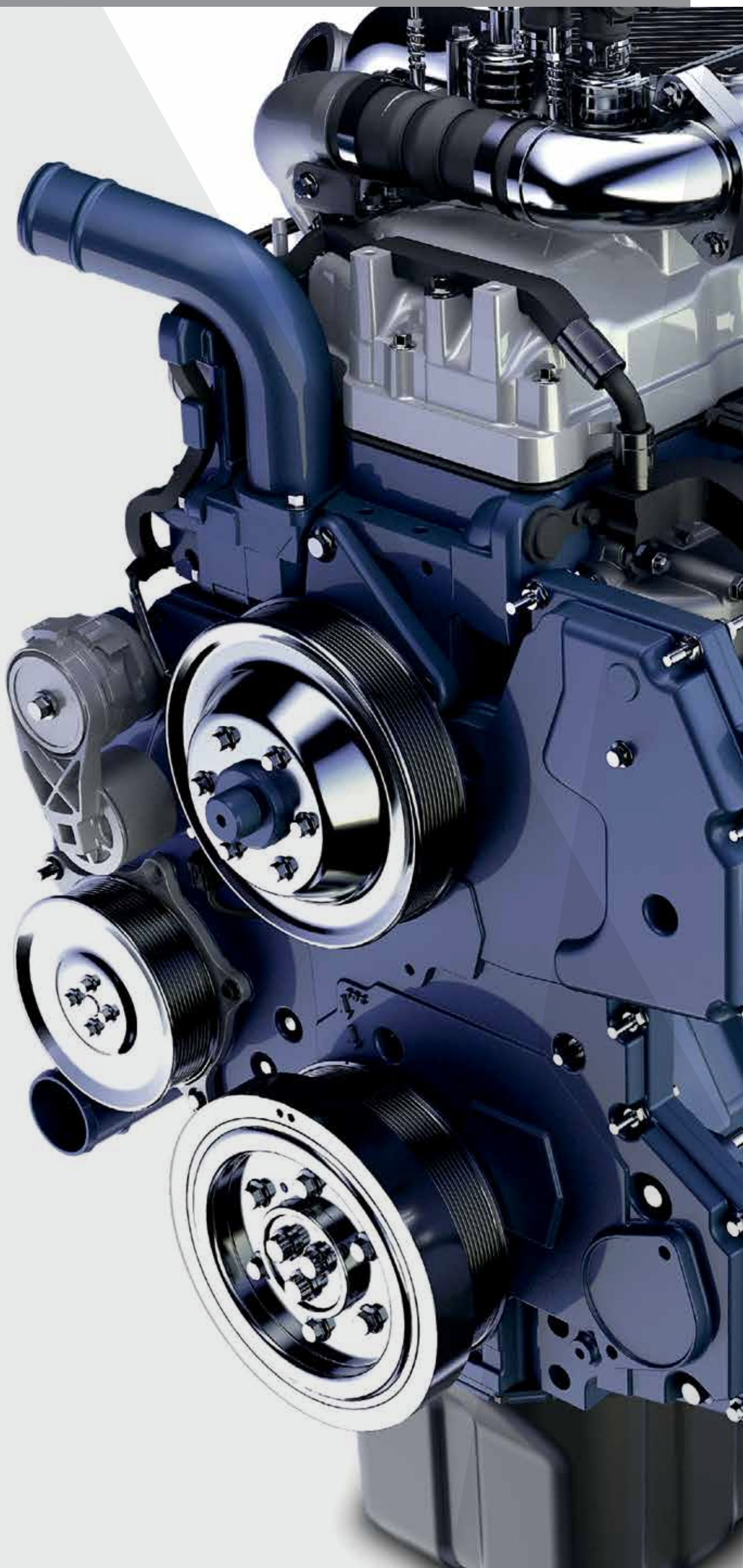

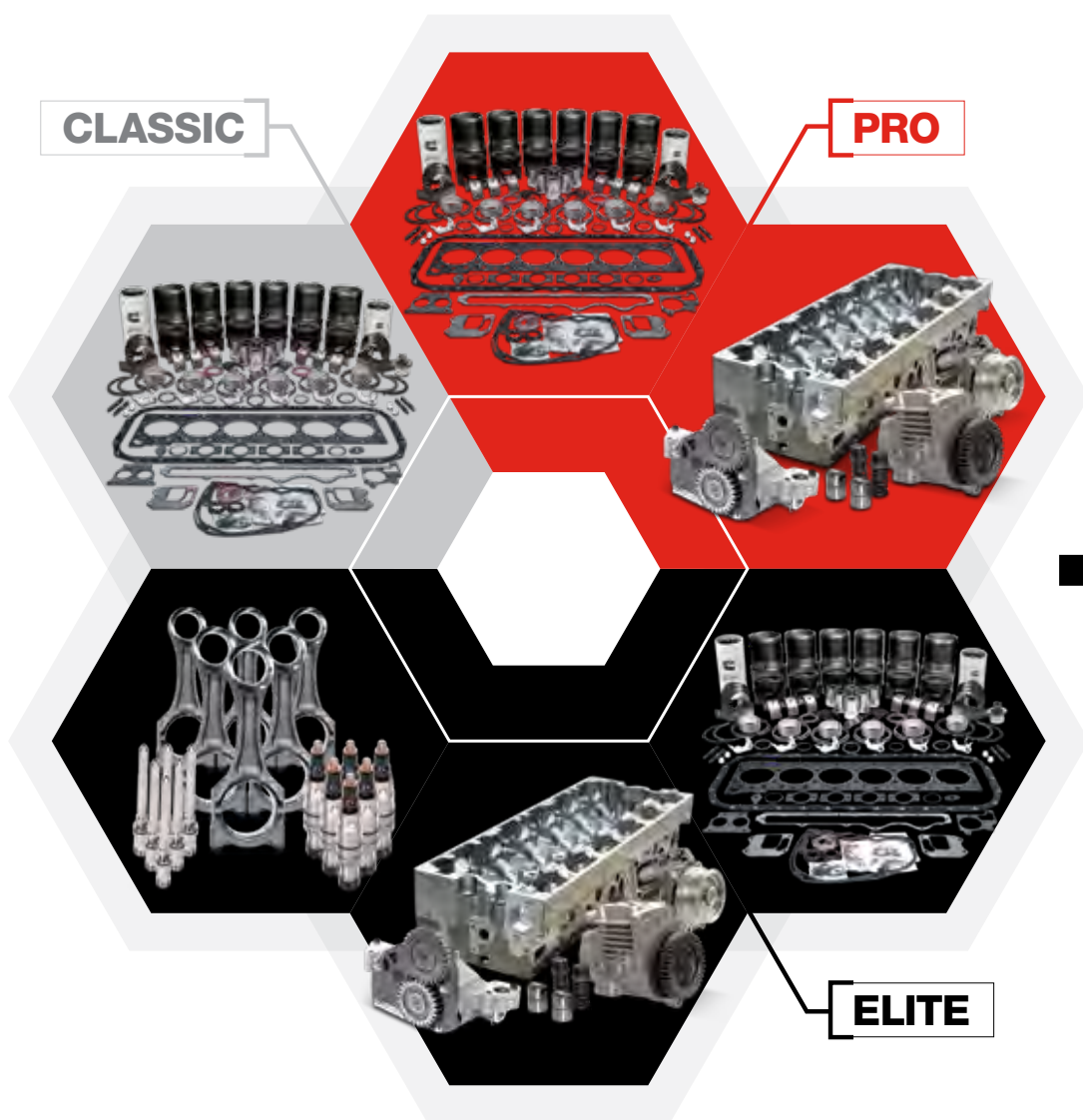

NOW[®]

National Overhaul Warranty

GENUINE CUMMINS ISX OVERHAUL KITS

Cummins ISX Overhaul Kits for EPA 2010 and newer engines are available in three tiers: CLASSIC, PRO and ELITE.

CLASSIC	PRO	ELITE
Pistons and rings Cylinder liners Bearings Upper and lower gasket kits Thermostat Oil and fuel filters and more	All contents of CLASSIC kit Cylinder head Lube pump Water pump Fuel pump	All contents of the PRO kit Connecting rods Injectors Fuel supply connectors
Necessary components for a basic power cylinder rebuild.	For any overhaul that requires a cylinder head, this is the best value and Cummins most recommended overhaul.	Recommended for customers wanting the ultimate overhaul and with inclusion of injectors and connectors.

PRO and ELITE kits also contain all parts required to qualify for National Overhaul Warranty (NOW) coverage. Cummins NOW certified repair locations can offer their customers the peace-of-mind that only a NOW extended warranty can provide by covering both replaced and inspected parts.

For more information contact your local Cummins representative.
For more details visit the Promotions Tab: quickserve.cummins.com
Certified Dealers can find more information here: dealer.cummins.com
Marketing material can be sourced here: mart.cummins.com
For more information on NOW coverages: cummins.tech/now2022

CUMMINS ENGINE



OVERHAUL KITS*

PN	DESCRIPTION	CERTIFICATION	CPLS (OHKS ONLY)	PISTON KIT PN (OHKS ONLY)
ISX				
5693737		EPA 2010, 2013	3606, 3766, 3938, 3939, 4584, 4585, 4587, 4588	4376567
5693738			3719, 3937, 4583, 4586, 4761	4376566
5693833			3348, 3376, 3490, 3491, 3688	2881758
5693831	ISX15 CLASSIC Overhaul Kit (150mm Liner)	EPA 2017	4343	5405828
5693832			4342	5405829
6324448			EPA 2021	5535, 5779, 5348
6324450	5479, 5349	5633495		
5579451	ISX15 CLASSIC Overhaul Kit (152mm Liner)	EPA 2010, 2013	3348, 3376, 3490, 3491, 3688	2881758
5579455			3606, 3766, 3938, 3939, 4584, 4585, 4587, 4588	4376567
5579461			3719, 3937, 4583, 4586, 4761	4376566
5693834RX	ISX15 PRO Overhaul Kit (150mm Liner)	EPA 2010, 2013	3348, 3376, 3490, 3491, 3688	2881758
5693837RX			3606	4376567
5693838RX			3766, 3939, 4585, 4588	4376567
5693842RX			3719	4376566
5693843RX			3937, 4583, 4586, 4761	4376566
6324451RX			EPA 2017	4342
6324452RX	4343	5405828		
5693835RX	ISX15 ELITE Overhaul Kit (150mm Liner)	EPA 2010, 2013	3348, 3376, 3490, 3491, 3688	2881758
5693839RX			3766, 3939, 4585, 4588	4376567
5693840RX			3606	4376567
5693844RX			3719	4376566
5693845RX			3937, 4583, 4586, 4761	4376566
6324454RX			EPA 2017	4342
6324455RX	4343	5405828		
ISL				
5529527	ISL 8.9 Overhaul Kit	EPA 2013	388, 1286, 1480, 1793, 1861, 1978, 1979, 1980, 2176, 2724, 3158, 3211, 3212, 3312, 3435, 3630, 4159, 4254, 4805, 8419, 8600, 8703	4089944
5633435			4759, 3664, 4525, 4612, 3665, 4526, 4613, 4760, 5239	4309527
5633436			EPA 2017	4611, 4524, 3663, 4758, 4799, 4800
ISB				
5579326	ISB 6.7 Overhaul Kit	EPA 2013	3610	4376347
5633357			3066	4376347
5633409	ISB 6.7 Overhaul Kit	EPA 2017	4569, 4570	5405856
5633410			4567, 4568, 4660, 4661	4376377

*Due to variation among the same engine family, an engine serial number must be used to determine the proper part.





CUMMINS ENGINE (CONT'D)

FUEL SYSTEM*

PN	DESCRIPTION	CERTIFICATION
----	-------------	---------------

ISX INJECTORS

5579419PX	Fuel Injector Kit (Injector and Connector)	EPA 2013
5579421PX		EPA 2017
5633476PX		EPA 2021

ISX FUEL PUMPS

4359489PX	Fuel Pump	EPA 2010, 2013
5491785PX		
5491784PX		EPA 2017
5594630PX		
5593971PX		EPA 2021
5594625PX		

ISL INJECTORS

5579405PX	Fuel Injector Kit	EPA 2010
5579407PX		
5579409PX		EPA 2013
5633612		

ISL FUEL PUMPS

4307021RX	Fuel Pump	EPA 2013
4384224RX		
5491997RX		

ISB INJECTORS

5254261PX	Injector	EPA 2013
5254261QX	Injector – Pack of 6	
5256034PX	Injector	
5256034QX	Injector – Pack of 6	

ISB FUEL PUMPS

5398557RX	Fuel Pump	EPA 2013
5399800RX		EPA 2017
5258264RX		EPA 2021

*Due to variation among the same engine family, an engine serial number must be used to determine the proper part.



PUMPS*

PN	DESCRIPTION	CERTIFICATION
----	-------------	---------------

ISX WATER PUMPS

4386576	Water Pump Cartridge	EPA 2010/2013
4386577		
3692576		EPA 2017
3692580		
5486706	Water Pump	EPA 2021
6305091RX		EPA 2010, 2013
6305092RX		
6305089RX		EPA 2017
6305090RX		
6305088RX		EPA 2021

ISX OIL PUMPS

5680039RX	Lubricating Oil Pump	EPA 2013
3693265RX		EPA 2017
5558808		EPA 2021
5615378		
5679969	EPA 2021	
5680023		

ISL WATER PUMPS

5402699	Water Pump	EPA 2010
5633585	Water Pump Kit	EPA 2021
5633586		

ISL OIL PUMPS

5449240	Lubricating Oil Pump	EPA 2013
---------	----------------------	----------

ISB WATER PUMPS

5473173	Water Pump	EPA 2013
5473174		
5473237		
5521882		
5525710		EPA 2017

ISB OIL PUMPS

5291050	Lube Oil Pump	EPA 2013
---------	---------------	----------

*Due to variation among the same engine family, an engine serial number must be used to determine the proper part.



PARTS.CUMMINS.COM

Servicing a Cummins engine? Start your parts research on parts.cummins.com. Our online parts catalog allows you to locate applicable parts for a Cummins Engine Serial Number (ESN), ATSN, GSN, part number or description. Visit quickserve.cummins.com for published repair practices.



CUMMINS ENGINE (CONT'D)



TURBOS*

PN	DESCRIPTION	CERTIFICATION	TURBO ACTUATOR PN
ISX			
5357368RX	ISX15 Turbocharger Kit	EPA 2013	4034289RX
5458260RX			
5458272RX		EPA 2017	5501185RX
5459710RX			
5459711RX			
5602145RX	EPA 2021		
ISL			
4352566RX	ISC/L 8.9 Turbocharger Kit	EPA 2013	4034126RX
5326680RX			5603776RX
5324121RX			5496045RX
3798351RX			
5326682RX			
3798338RX			
5324131RX		EPA 2021	
3798339RX			
5606425RX			
ISB			
3798327RX	ISB 6.7 Turbocharger Kit	EPA 2013	5498269
5327360RX			5496045RX
5604188RX		EPA 2017	5498269
5604175RX			
5603720RX			



*Due to variation among the same engine family, an engine serial number must be used to determine the proper part.

RECON ENGINES

PN	DESCRIPTION	CERTIFICATION	
ISX			
DR7042NX	ENG ISX15 13 B 500@1800 XPI	EPA 2013	
DR7046NX	ENG ISX15 13 B 450@1650 XPI		
DR7046RX	ENG ISX15 13 B 450@1650 XPI		
DR7048NX	ENG ISX15 13 B 600@1900 XPI		
DR7079RX	ENG ISX15 13 B 500@1800 XPI		
DR7080RX	ENG ISX15 13 B 600@1900 XPI		
DR7708RX	ENG ISX15 16 B 450@1800 XPI		
DR7739RX	ENG ISX15 13 B 450@1800 XPI		
DR7740RX	ENG ISX15 13 B 500@1800 XPI		
DR7792RX	ENG ISX15 16 B 450@1800 XPI		
DR7690NX	ENG X15 16 B 605@1950 XPI		EPA 2017
DR7691NX	ENG X15 16 B 450@1800 XPI		
DR7872NX	ENG X15 21 B 500@1700 XPI	EPA 2021	
ISL			
DR7072RX	ENG ISL 8.9 13 B 380@2000 HPCR	EPA 2013	
DR7765RX	ENG ISL 8.9 13 B 280@2200 HPCR		
DR7073RX	ENG ISL 8.9 13 B 300@2000 HPCR		
ISB			
DR7702RX	ENG ISB6.7 13 B 240@2400 HPCR	EPA 2013	
DR7756RX	ENG ISB6.7 13 B 220@2400 HPCR		
DR7703RX	ENG ISB6.7 13 B 250@2400 HPCR		
DR7722RX	ENG ISB6.7 13 B 200@2400 HPCR		



CYLINDER HEADS*

PN	DESCRIPTION	CERTIFICATION
ISX		
5708760RX	Cylinder Head	EPA 2010, 2013
5658301RX		
5658294RX		EPA 2017
5658302RX		
5628269RX		
5658309RX		
5658106RX	EPA 2021	
ISL		
5569421RX	Cylinder Head	EPA 2013
5569672		EPA 2021
5626961RX		
ISB		
5361601RX	Cylinder Head	EPA 2013

*Due to variation among the same engine family, an engine serial number must be used to determine the proper part.





CUMMINS ENGINE (CONT'D)

DIESEL PARTICULATE FILTERS*

PN	DESCRIPTION	CERTIFICATION	PREMIUM DPF CLAMP & GASKET KIT
ISX			
5579296	Particulate Filter Kit	EPA 2013	—
5579295			
5633711			
5579299			
5633708		EPA 2017	5510227
5579298			
5579297			
ISL			
5579358	Particulate Filter Kit	EPA 2013	—
5579357			
5579356			
5418020			
5579362		EPA 2017	5510228
5633713			
5579361			
5579359			
5579360			
ISB			
5579368	Particulate Filter Kit	EPA 2013	—
5579367			
5579380		EPA 2017	
5633697			
5633712			
5579373			
5579377			
5579378			
5579376			
5579375			
5579379			
5579374			
5579372			
5579371			
5579370			
5579369			



*Due to variation among the same engine family, an engine serial number must be used to determine the proper part.

EGR COOLERS*

PN	DESCRIPTION	CERTIFICATION
ISX		
4352360	EGR Cooler	EPA 2010, 2013
4376143		
5405814		EPA 2017
5405901		
5633491		EPA 2021
5693789		
ISL		
4352348	EGR Cooler	EPA 2010
4376312		
4352347		EPA 2013
5566887		
5566888		
ISB		
4309428	EGR Cooler	EPA 2013
5566894		
5566897		EPA 2017

*Due to variation among the same engine family, an engine serial number must be used to determine the proper part.

AFTERTREATMENT SERVICE KITS

PN	DESCRIPTION	CERTIFICATION
QUICK KIT		
5693712RX	Aftertreatment Service Kit (12V)	EPA 2010
5693713RX	Aftertreatment Service Kit (24V)	
5693714RX	Aftertreatment Service Kit (12V)	EPA 2013
5693715RX	Aftertreatment Service Kit (24V)	
PREMIUM KIT		
5633468RX	Aftertreatment Service Kit (12V)	EPA 2010
5633469RX	Aftertreatment Service Kit (24V)	
5633470RX	Aftertreatment Service Kit (12V)	EPA 2013
5633471RX	Aftertreatment Service Kit (24V)	
ULTIMATE KIT		
5633659RX	Aftertreatment Service Kit (12V)	EPA 2010
5693716RX		
5633660RX	Aftertreatment Service Kit (24V)	
5693717RX		
5633661RX	Aftertreatment Service Kit (12V)	EPA 2013
5693718RX		
5693719RX	Aftertreatment Service Kit (24V)	
5633662RX		



CUMMINS ENGINE (CONT'D)

DIESEL OXIDATION CATALYSTS*

PN	DESCRIPTION	CERTIFICATION
ISX		
4353249RX 4353285RX 4353251RX 4353264RX 4328760RX 4353221RX	Inlet Catalyst Module	EPA 2013
4394756RX		EPA 2017
5509698RX 5509693RX 5509694RX		EPA 2021
ISL		
4353303RX 4353289RX 4353296RX 4353304RX 4353305RX 4353290RX 4353318RX 4353298RX 4353299RX 4353301RX	Inlet Catalyst Module	EPA 2013
ISB		
4353324RX 4353353RX 4353366RX 4353323RX 4353328RX 4353364RX 4353362RX	Inlet Catalyst Module	EPA 2013
5418478RX 5418479RX 4394820RX		EPA 2017

*Due to variation among the same engine family, an engine serial number must be used to determine the proper part.

AFTERTREATMENT SENSORS

PN	DESCRIPTION	CERTIFICATION
ISX		
3687930RX 3688978RX 4326870RX 4326872RX	Nitrogen Oxide Sensor	EPA 2013
5486591RX 5486592RX		EPA 2017
5679700 5698480		EPA 2021
ISL		
4326862RX 4326864RX 4326865RX 4326866RX 4326867RX 4326868RX 4326873RX 4326874RX 5293529	Nitrogen Oxide Sensor	EPA 2013
ISB		
5289662 5289662RX 5293535 5295473RX 5305727	Nitrogen Oxide Sensor	EPA 2013
ALL		
5461550RX 5461551RX 5461552RX 5461553RX 5461554RX 5461555RX 5461556RX 5461557RX	Particulate Sensor	EPA 2017

**DEALER.CUMMINS.COM**

Looking for the latest Cummins news related to dealer programs, promotions, part offerings, dealer trainings, the dealer contact manual and easy access to other Cummins sites?

Visit the Cummins Dealer Portal dealer.cummins.com



IT'S TIME TO CHANGE.

SET PRICING MAKES CHANGING FILTERS EASIER THAN EVER.

With Fleetrite® filters, you can get proven performance in your vehicle with convenient set pricing. Fleetrite is dedicated to keeping you on the road by providing the best in quality, coverage and value. All heavy-duty filters are warranted to be free from defects in material and workmanship.

Visit [Fleetrite.com](https://www.fleetrite.com) to find one of our over 700 locations.



 **FLEETRITE®**

FILTERS



AIR FILTERS

PN	APPLICATION	TYPE	FLEETRITE X-REF	DONALDSON X-REF	BALDWIN X-REF
AD27747	Cummins ISBE5, B160-10, DAF PF100M Series Euro 2/3	Primary	FLTAFAM001	—	—
AF1968	Caterpillar 3176; Cummins 6B5.9, Signature 600; Detroit Diesel® Series 60®	Primary	FLTAFKW009	P537791, P525493	PA4585, PA2705
AF25119	Yanmar TK486	Primary	FLTAFTK020	P953446	RS5387 KIT
AF25139M	Cummins ISX12, ISL G, ISM, ISL9	Primary	FLTAFAM002	P527682	BALRS3518
AF25345	Cummins ISL G (8.9), ISM11	Primary	FLTAFIH011	P537286, P527683	RS3519
AF25550	Caterpillar CAT 7BJ1, UP	Primary	FLTAFAM022	P822686	RS3715
AF25707	International VT365; International MaxxForce® 7; Cummins B6.7	Primary	FLTAFIH001	P606503	BALRS4636
AF25732	International VT365; International MaxxForce® 7; Cummins B6.7	Primary	FLTAFIH007	—	—
AF26103	International DT466; International MaxxForce® DT	Primary	FLTAFIH021	P613336	BALRS4862
AF26107	IHC HT570; International MaxxForce® DT, MaxxForce® 9	Primary	FLTAFIH017	P606503	RS4636
AF26154	Detroit Diesel® DD8; Caterpillar C7; Mercedes-Benz MBE906 (6.4L)	PAC	—	P548070, P607955	CA4700
AF26163M	Cummins ISC 8.3	Primary	FLTAFCE025	—	—
AF26235	Detroit Diesel® DD15®, Series 60®; Mercedes-Benz MBE4000; Caterpillar C15; Cummins ISX15	Cabin	FLTC26235FL	P609422	PA4857
AF26268	International DT466; International MaxxForce® DT	Primary	FLTAFIH023	—	—
AF26405	Cummins ISC 8.3	Cabin	FLTC26405	P606555	PA4681
AF26427	Cummins L9; Caterpillar C7; Detroit Diesel® DD15®	Cabin	FLTC26427FL	P614547	PA5359
AF26430	International MaxxForce® 7, MaxxForce® DT, DT466	Cabin	FLTC26430IN	P614221	BALPA4985
AF26472M	Cummins ISC 8.3	Primary	FLTAFV0005	—	—
AF27693	General Motors V8 6.0L 364 CID, L4 3L 3000CC 183CID	Primary	FLTAFIS005	P543614, P828633	RS5434
AF4878	Caterpillar 3116, 3126, 3126E	Primary	FLTAFIH003	DBA5067	RS2863
AF55839	Cummins B6.7, ISX15, X15; International A26	OAH	FLTAFIH018	P640110	PA30093
AF56500	Mercedes-Benz MBE4000; Cummins ISX15; Detroit Diesel® DD16®	Primary	—	P618478	BALCA5790



FUEL FILTERS

PN	APPLICATION	FLEETRITE X-REF	DONALDSON X-REF	BALDWIN X-REF
FF2200	Cummins ISX07, ISX02, ISX15	FLTFFAM008	P552200	BF7766, BK6440
FF5507	Mack MP7, MP8	FLTFFVO012	—	—
FF5776	Cummins ISX12, ISX, ISX15	FLTFFPB003	—	—
FF5825NN	Cummins X15	FLTFFPB003	P555776	BF9885
FF63054NN	Cummins ISB6.7, B6.7, ISL9, L9 2014 – 2020	—	P553009	BALBF63000
FK13850NN	Detroit Diesel® DD13®, DD15®, DD16® 2014 – Current	—	P551063	PF9908
FS1003, FS19596	Cummins ISL9, ISC 8.3, ISM11	FLTFFIS020	P564872, P551003, P551103	BF1293SPS, BF1263SP
FS19551	Detroit Diesel® Series 60™, Caterpillar C7; Cummins ISC 8.3	FLTFFR015	P551066, P551855	BF13900, BF12940
FS19727	Caterpillar C7, ISB6.7	FLTFFAM035	P551052	PF7895
FS19729	Cummins ISX07; Caterpillar C7, C15	FLTFFIH013	P550737	PF7755
FS19764	Cummins ISX12, ISX15	FLTFFPB006	P550849	PF9814
FS19765	Cummins ISX; International MaxxForce®; Mack E7, Mack MP7-8-10; PACCAR MX EPA 13; Volvo VDE	FLTFFAM037	P550851	PF7930
FS19947	International MaxxForce® DT, MaxxForce® 7; IHC DT466; International DT466	FLTFFIH009	P550824	PF7978
FS20083	Freightliner Cascadia DD13®, DD15®	FLTFFAM032	P580710	PF46145



The High Cost of Low-Quality Filtration

Using low-quality fuel filtration contributes to a higher rate of unplanned downtime and maintenance expenses as a result of premature wear on the fuel system, power cylinder and even exhaust aftertreatment components.

fleetguard.com



FILTERS (CONT'D)



LUBE FILTERS

PN	APPLICATION	FLEETRITE X-REF	DONALDSON X-REF	BALDWIN X-REF
LF14000NN	Cummins X15, ISX11.9L, ISX15L, MX13	FLTLFAM002	P550949, P559000	BD50000
LF16110	HINO J08E; VC	FLTLFHI007	P903196	BD7325, B7513
LF16141	Kubota Z482B	—	—	—
LF16233	PACCAR MX300S, MX13; DAF MX13 (EURO 6)	FLTLFPB013	P550812	P40019, P7354
LF16242	General Motors V8 6.0L 364 CID, V8 4.8L 294 CID	FLTLFBB018	P550794	B160
LF17501	General Motors L4 3L 3000CC 183CID; Isuzu 4JJ1 TCS Sitec Series II 150	FLTLFIS010	—	P40021
LF17502	Mack MP7, MP8, MP10	FLTLFAM021	P550425	B7409
LF17503	Mack MP7; Renault Trucks DT111, Euro 6	FLTLFCAG025	P553191	B76
LF17511	Freightliner Cascadia DD13 [®] , DD15 [®]	FLTLFAM003	P7505	P7505
LF17537	Isuzu 4HK1 TC, 4HK1 (5.2L)	FLTLFIS014	P502042	BD7169
LF3000	Cummins 6CTA8.3, LTAA10, L10	FLTLFAM008	BD103	P553000
LF3335	Caterpillar 3208, CT13, CT11	FLTLFFR011	P552430, P550426	B1413
LF3341	Caterpillar 3406E, C7, 3126; Cummins ISM	FLTLFAM015	P779217	B233
LF3349	Cummins QSB5.9	—	—	—
LF3620	Detroit Diesel [®] Series 60 [®]	FLTLFDDE023	P552100	B495
LF3630	International VT275, T444E	—	—	—
LF3654	Volvo VED12, VED7, VE7; Mack MP10	FLTLFV0006	P550425, P559106, P559647, P559664, P903269, P903270, P903271, P903272, P903273	B7685, B7409, BK6650, BK6656, BK6956
LF3681	Ford V8 5.4L 330 CID, V10 6.8L 415 S	FLTLFFD019	P550965	B329
LF3818	HINO J05C, J08E, J05D, J05DTG	FLTLFHI012	P903197, P552050	B7155
LF3883	International DT466; Detroit Diesel [®] Series 40 [®]	FLTLFAM026	P550367	B7030
LF3970	Cummins L/B Series, ISB 6.7L	FLTLFFR001	P550428, P551019	B7177, BK6031
LF667	Caterpillar 3126, C7 (7.2L); Mack MP7 (10.8L), MP8 (12.8L), MP10 (16.1L); Volvo D12A, D12B, D12C, D12D	FLTLFV0005	P779143, P559576	B7600, B76SS, B76B
LF691A	Caterpillar 3408, 3406, 3306, 3176, C10	FLTLFCAG022	P554005	B7299
LF780	ABC-L4-2.5L-150	—	—	—
LF9009	Cummins L/B Series	FLTLFAM016	P553000	BD7309, BK6032
LF9025	IHC DT1466, DT530, DTA466, DT466E	FLTLFIH004	P550656, P552025	BD7250, BK6652
LF9070	Cummins ISM11, ISX15; Signature 600	FLTLFFR009	P550949, DBL7900	BD7153
LF9667	Caterpillar 3126, 3116; Gardner 6LXB180	FLTLFAM024	P554004	B7600



DEF FILTERS

PN	APPLICATION	FLEETRITE X-REF	DONALDSON X-REF	BALDWIN X-REF
UF101	PACCAR MX-13, Hino 195	FLTFDEF101	BF1179	P552398
UF106	Freightliner Cascadia DD13 [®] , DD15 [®] ; Cummins X15; PACCAR MX-13, DD13 [®] , DD15 [®] , DD16 [®]	FLTFDEF106	—	PE17002 KIT



TRANSMISSION FILTERS

PN	APPLICATION	DONALDSON X-REF	BALDWIN X-REF
162097, 148459	Ford E8NN-6714-CA; Mack 6432PER17; Onan 122-0185; White 156513A	P779197, P550882	BALB163
TF15027	Ford V10-6.8L; 6.0L; V8 281 4.6L F.I. (Vin W)	P552477	18029
TF15040	General Motors V8 325 5.3L F.I. (Vin M)	P552479	18056
TF15082	Caterpillar 3126; 3126E; General Motors 8.1L	—	BAL20003
TF15088	Ford V8 379 6.2L FI (VIN 6); 406 6.7L DI Turbo Diesel	—	20028



Give your baby **the best.**



Show your truck some love with genuine **Fleetguard filters and parts**. Our advanced technology **prevents engine wear, boosts fuel efficiency, minimizes repairs** and keeps engines running like new. And all our products are **backed by the best warranty** in the business. Doesn't your truck deserve Fleetguard?



For more information, see your local dealer or visit:
Fleetguard.com

ENGINES



RENEWED I-6 ENGINES

PN	DESCRIPTION
5010940R91	RENEWED™ 334 DT466ST, 230HP or Less, Front Sump
5010941R91	RENEWED™ I334 DT466HT, 245HP and Above, Front Sump
5010943R91	RENEWED™ I334 DT570, Front Sump
4307102R92	RENEWED™ I326 DT466, Long Block, 210HP-255HP with Ladder 2007 – 2009
4307101R92	RENEWED™ I326 DT466, Trimmed, 210HP-230HP with Ladder 2007 – 2009
5010869R93	RENEWED™ I326 DT570, Trimmed Reman 2008 – 2009
5012872R91	RENEWED™ A26 LT, Reman CSA, Rear Sump, Non-Endurant
5012873R91	RENEWED™ A26 LTE, Reman CSA, Rear Sump, Endurant
5012874R91	RENEWED™ A26 RHE, Reman without CSA, Front Sump, Endurant
5012875R91	RENEWED™ A26 RH, Reman without CSA, Front Sump, Non-Endurant
5012876R91	RENEWED™ Reman HV/HX with Engine Brake
5012877R91	RENEWED™ Reman HV with PTO



RENEWED V ENGINES

PN	DESCRIPTION
5010795R91	RENEWED™ MaxxForce® 7 V152/179, Trimmed
5010809R91	RENEWED™ MaxxForce® 7 V152, Trimmed
5010228R92	RENEWED™ VT365, Trimmed 2004 – 2006



TURBOCHARGERS



RENEWED TURBO KITS

PN	DESCRIPTION	APPLICATION
5011054R92	RENEWED™ Turbo, High Pressure I3L	I783
5011058R92	RENEWED™ Turbo, Low Pressure I3L	I783
5011060R92	RENEWED™ Turbo, Cartridge High Pressure I3L	I783
5012231R92	RENEWED™ Turbo, Low Pressure 770 15L	I770
1847620C93	Turbo Actuator I313	I313
5010569R91	RENEWED™ Turbo, Low HP, 2005 – 2006 Low Mount	I313
5010720R93	RENEWED™ Turbo, I326 DT466 245HP Low HP	I326
5010724R93	RENEWED™ Turbo, I326 DT570	I326
5010722R93	RENEWED™ Turbo, I326 DT466 285HP High HP	I326
5010930R91	RENEWED™ Turbo, HP STD I-334 DT466	I334
5010934R91	RENEWED™ Turbo, LP STD I-334 DT466	I334
5010769R91	RENEWED™ Turbo, Assembly	V134
5010803R92	RENEWED™ Turbo, HP V152	V152
5010808R92	RENEWED™ Turbo, LP V152	V152
5010448R93	RENEWED™ Turbo, VT365 International 2004 – 2006	VT365
5013151R91	RENEWED™ A26 Turbo Kit	A26
5012332R91	RENEWED™ A26 Turbo Actuator Kit	A26



INJECTORS



INJECTOR REPLACEMENT KITS

PN	DESCRIPTION	APPLICATION
5012131R91	RENEWED™ Injector Kit, DT466 Low HP	I313
5012132R91	RENEWED™ Injector Kit, DT466 Low HP	I313
5012133R91	RENEWED™ Injector Kit, DT466 High HP	I313
5012134R91	RENEWED™ Injector Kit, DT466 High HP	I313
5012135R91	RENEWED™ Injector Kit, DT466	I313
5012136R91	RENEWED™ Injector Kit, DT466	I313
5012137R91	RENEWED™ Injector Kit, DT466 I326 210HP-300HP	I326
5012138R91	RENEWED™ Injector Kit, DT466 I326 210HP-300HP	I326
5012139R91	RENEWED™ Injector Kit, I334/DT466	I334
5012140R91	RENEWED™ Injector Kit, I334/DT570	I334
2517613C91	Injector Kit, I786	I786



FLEETRITE FUEL INJECTORS

PN	DESCRIPTION	APPLICATION
FLTFI2593595	Fuel Injector, I308 with Seals	I308
FLTFI2593597	Fuel Injector, I308 with Seals	I308
FLTFI2593594	Fuel Injector, I-Series HEUI with Seals	I308
FLTFI1831487	Fuel Injector, T44E with Seals	T444E
FLTFI2593592	Fuel Injector, I-Series HEUI with Seals	I308
FLTFI2593596	Fuel Injector, I-Series HEUI with Seals	I308
FLTFI2593588	Fuel Injector, I-Series HEUI with Seals	I308
FLTFI1824583	Fuel Injector, T44E with Seals	T444E



OVERHAUL KITS



INTERNATIONAL

PN	DESCRIPTION	FLEETRITE X-REF
1888653C95	Engine Overhaul Kit, DT466, I308	FLTWK1888653
1889992C94	Engine Overhaul Kit, DT466, I308	FLTWK1889992
1876205C98	Engine Overhaul Kit, I308	FLTWK1876205
1894140C92	Engine Overhaul Kit, I308-530	—
7081279C93	Engine Overhaul Kit, I313-570	—
1889238C99	Engine Overhaul Kit, I326	—
1889280C97	Engine Overhaul Kit, DT570	—
1893941C98	Engine Overhaul Kit, DT466 215-230HP	—
2517040C92	Engine Overhaul Kit, DT466 250HP and Above	—
2517041C91	Engine Overhaul Kit, DT570 300HP and Above	—



FLEETRITE

PN	DESCRIPTION	INTERNATIONAL X-REF
FLTWK1841391	Engine Overhaul Kit, DT466E, 230HP and Below	—
FLTWK1888653	Engine Overhaul Kit, DT466, 2000 – 2002 and 2004, 215HP and Below	1888653C95
FLTWK1889992	Engine Overhaul Kit, DT466, 2000 – 2002 and 2004, All 230HP and 250HP	1889992C94
FLTWK1897395	Engine Overhaul Kit, I313, DT466	—



AFTERTREATMENT



INTERNATIONAL

PN	DESCRIPTION	APPLICATION
2612521C91	Diesel Particulate Filter	Medium-Duty
2611630C91	Diesel Particulate Filter	Medium-Duty
2604873C91	Diesel Particulate Filter	Medium-Duty
2520606C91	Diesel Particulate Filter Kit with DPF and Gasket	Heavy-Duty
2609066C91	DOC/DPF Assembly	Medium-Duty
2604869C91	Diesel Oxidation Catalyst	Medium-Duty
2612800C91	Diesel Oxidation Catalyst	Medium-Duty
2605802C1	Diesel Oxidation Catalyst	Medium-Duty
5011044R1	RENEWED™ Diesel Oxidation Catalyst	Medium-Duty

DURAFIT

PN	DESCRIPTION	APPLICATION
DFTC170033	Diesel Particulate Filter	Caterpillar C7
DFTC170034	Diesel Particulate Filter	Caterpillar C9, C15
DFTC170035	Diesel Particulate Filter	Mack and Volvo MP7
DFTC170036	Diesel Particulate Filter	Detroit Diesel® Series 60°
DFTC170039	Diesel Particulate Filter	Detroit Diesel® MB OM926
DFTC170040	Diesel Particulate Filter	Caterpillar C13, C15
DFTC170045	Diesel Particulate Filter	Mack and Volvo D11, DD13®, DD16°
DFTC170046	Diesel Particulate Filter	Mack and Volvo MP7, MP8
DFTC170048	Diesel Particulate Filter	Mack and Volvo MP8
DFTC170050	Diesel Particulate Filter	Caterpillar C9
DFTC170051	Diesel Particulate Filter	Caterpillar C13, C15
DFTC170052	Diesel Particulate Filter	Caterpillar C9, C7
DFTC170057	Diesel Particulate Filter	Volvo D13
DFTC170066	Diesel Particulate Filter	Detroit Diesel® Series 50°
DFTC170067	Diesel Particulate Filter	Detroit Diesel® DD13®, DD15°
DFTC170069	Diesel Particulate Filter	Caterpillar C7
DFTC170072	Diesel Particulate Filter	Isuzu 6HK1
DFTC170075	Diesel Particulate Filter	Mack and Volvo MP7
DFTC170076	Diesel Particulate Filter	Detroit Diesel® DD13®, DD15°
DFTC170077	Diesel Particulate Filter	Detroit Diesel® DD13®, DD15° 1-Box (Long Unit)
DFTC170083	Diesel Particulate Filter	Hino JO8E
DFTC170089	Diesel Particulate Filter	Mack and Volvo MP7, MP8
DFTC170103	Diesel Particulate Filter	PACCAR MX
DFTC170112	Diesel Particulate Filter	Detroit Diesel® Series 60°
DFTC170122	Diesel Particulate Filter	Caterpillar C7
DFTC200008	Diesel Oxidation Catalyst	Mack and Volvo MP7
DFTC200010	Diesel Oxidation Catalyst	Detroit Diesel® DD15°
DFTC200064	Diesel Oxidation Catalyst	Detroit Diesel® DD13®, DD15°, S60°; Mercedes-Benz MBE4000
DFTC200068	Diesel Oxidation Catalyst	Detroit Diesel® DD13®, DD15°, S60°; Mercedes-Benz MBE4000
DFTC200069	Diesel Oxidation Catalyst	Detroit Diesel® DD13®, DD15°, S60°; Mercedes-Benz MBE4000
DFTC200070	Diesel Oxidation Catalyst	Detroit Diesel® DD13®, DD15°, S60°; Mercedes-Benz MBE4000



Replace Your CAC and Radiator After an Engine Replacement

It is recommended to replace your CAC and radiator after an engine replacement or overhaul to ensure maximum long-term engine durability.

fleetrite.com



EGR



EGR COOLERS

PN	DESCRIPTION	APPLICATION	RENEWED X-REF
2513976C92	EGR Cooler Kit, High Fin Density	I334	5012354R91
5010874R92	RENEWED™ I326 EGR Cooler Kit	I326	—
7090595C93	EGR Cooler Kit, 330 MM	I326	—
2513209C91	EGR Cooler Kit, LT	I783	—
2513445C91	EGR Cooler Kit, HT	I783	—
1848258C93	EGR Cooler Kit	I313	—
1832540C94	EGR Cooler Kit, 17"	I313	—
3014254C97	EGR Cooler Kit, High Temperature	I783	—
1899244C95	EGR Cooler Kit	V152	5012714R91

EGR VALVES

PN	DESCRIPTION	APPLICATION	RENEWED X-REF
1890997C92	EGR Valve	I334	5012972R91
1878918C2	EGR Valve with Manifold	I326	5012974R91
2517625C92	EGR Valve Kit	I786	5012713R91
3007672C94	EGR Valve Kit with Gaskets and Bolts	I783	5010696R94
5010696R94	RENEWED™ EGR Valve Kit with Gaskets and Bolts	I783	—
1842593C92	EGR Valve Kit	I313	5012976R91
1881385C94	EGR Valve without O-Rings	V152	—
5010918R92	RENEWED™ EGR Valve Kit	I718	—

EXHAUST



STACKS

INTERNATIONAL/FLEETRITE	DESCRIPTION	PACCAR/TRP X-REF	INTERNATIONAL/FLEETRITE X-REF	HEAVY DUTY MFG (HDE, HDM) X-REF	ALLIANCE X-REF
FLTSOC524C	Curved Stack, Chrome 24"	EP50CS224C	FLTSOC524C	3-501-24CP	ABP N49 50CS224C
FLTSOC536C	Curved Stack, Chrome 36"	EP50CS236C	FLTSOC536C	3-501-36CP	ABP N49 50CS236C
FLTSOC548C	Curved Stack, Chrome 48"	EP50CS248C	FLTSOC548C	3-501-48CP	ABP N49 50CS248C
FLTSOC560C	Curved Stack, Chrome 60"	EP50CS260C	FLTSOC560C	3-501-60CP	ABP N49 50CS260C
—	Curved Stack, Chrome 72"	EP50CS272C	—	3-501-72CP	ABP N49 50CS272C
—	Mitered Stack, Chrome 24"	EP50MS224C	—	2-501-24CP	—
—	Mitered Stack, Chrome 36"	EP50MS236C	—	2-501-36CP	ABP N49 50MS236C
—	Mitered Stack, Chrome 48"	EP50MS248C	—	2-501-48CP	ABP N49 50MS248C
—	Mitered Stack, Chrome 60"	EP50MS260C	—	2-501-60CP	ABP N49 50MS260C
—	Mitered Stack, Chrome 72"	EP50MS272C	—	2-501-72CP	ABP N49 50MS272C



CLAMPS AND MOUNT BUSHINGS

INTERNATIONAL/FLEETRITE	DESCRIPTION	PACCAR/TRP X-REF	INTERNATIONAL/FLEETRITE X-REF	HEAVY DUTY MFG X-REF	ALLIANCE X-REF
FLTEC50FUBZ	U-Bolt Flat Band Clamp, Chrome 5"	EC50FBC	FLTEC50FUBZ	19-500CP	ABP N35 500UBFC
—	Exhaust Bracket Mount Bushings, Pack of 8 Pieces	14-14656-4	—	—	—
FLTXC500GZI	Guillotine U-Clamp, 5" Diameter, Zinc-Plated	EC50GZ	FLTXC500GZI	18-500Z	ABP N35 500GCRS



EXHAUST (CONT'D)



EXHAUST BAND CLAMPS

INTERNATIONAL/ FLEETRITE	DESCRIPTION	PACCAR/TRP X-REF	ALLIANCE X-REF
FLTXC35EST	Flat Band Clamp, 304 Stainless Steel, 3-1/2"	EC35EST	ABP N35 35EST
FLTEC40EST	Flat Band Clamp, 304 Stainless Steel, 4"	EC40EST	ABP N35 40EST
FLTXC50EST	Flat Band Clamp, 304 Stainless Steel, 5"	EC50EST	ABP N35 50EST
FLTEC30PLA	Preformed Clamp, Aluminized, 3"	EC30PLA	ABP N35 30PLA
FLTEC35PLA	Preformed Clamp, Aluminized, 3-1/2"	EC35PLA	ABP N35 35PLA
FLTEC40PLA	Preformed Clamp, Aluminized, 4"	EC40PLA	ABP N35 40PLA
FLTXC40PLS	Preformed Clamp, 304 Stainless Steel, 4"	EC40PLS	ABP N35 40PLS
FLTEC50PLA	Preformed Clamp, Aluminized, 5"	EC50PLA	ABP N35 50PLA
FLTXC50PLB	Preformed Clamp, Polished 304 Stainless Steel, 5"	EC50PLB	—
FLTXC50PLS	Preformed Clamp, 304 Stainless Steel, 5"	EC50PLS	ABP N35 50PLS



MUFFLERS

FLEETRITE PN	TRP PN	DESCRIPTION	HEAVY DUTY MFG X-REF
FLT5510EM	EMM10682TRP	Vertical Muffler, 5" In and Out, 10" Diameter, 51" Long	31165
FLT86130M	EMM10130	Vertical Muffler, 5" In and Out, 10" Diameter, 51" Long	31063
—	EMM10196TRP	Vertical Muffler, 5" In and Out, 10" Diameter, 51" Long	—



EXHAUST BELLOWS

FLEETRITE PN	TRP PN	DESCRIPTION	APPLICATION	OE X-REF	ALLIANCE X-REF
FLTEBF411875	EBFL11875	4" Inlet x 18"	Freightliner	A04-26193-018	ABP N49 F28578
FLTEBF411878	EBFL11878	4" Inlet x 16"	Freightliner	A04-25023-016	ABP N49 F25023
FLTEBF411880	EBFL11880	4" Inlet x 16"	Freightliner	A04-26374-016	ABP N49 F26374
FLTEBF511876	EBFL11876	5" Inlet x 16.5"	Freightliner	A04-25022-018	ABP N49 F28522
FLTEBF511879	EBFL11879	5" Inlet x 18"	Freightliner	A04-27334-018	ABP N49 F27334
FLTEBI411870	EBNV11870	Kit 4" Inlet x 14.5"	International	2512967C91	ABP N49 I67C91
FLTEBI411871	EBNV11871	4" Inlet x 13"	International	3859154C1	ABP N49 I154C1
FLTEBI411872	—	4" Inlet x 12"	International	—	ABP N49 I462C5
FLTEBK411864	EBKW11864	4" Inlet x 13"	Kenworth	M66-7064-0330	ABP N49 KW0330
FLTEBK411865	EBKW11865	4" Inlet x 12.6"	Kenworth	M74-1020-002	ABP N49 KW3541
FLTEBP311861	EBPB11861	4" Inlet x 11.3"	Peterbilt	M66-7091-0320	ABP N49 PB0320
FLTEBP311862	EBPB11862	4" Inlet x 12.25"	Peterbilt	M66-7091-0335	ABP N49 PB0335
FLTEBP311863	EBPB11863	4" Inlet x 15.9"	Peterbilt	M66-7091-0405	ABP N49 PB0405
FLTEBV411867	EBVL11867	4" Inlet x 17.7"	Volvo	21428534, 21959393, 22307701	ABP N49 V28534
FLTEBV411868	EBVL11868	4" Inlet x 17.7"	Volvo	21428536, 21959395, 22307703	ABP N49 V28536
FLTEBV511869	EBVL11869	5" Inlet x 15.9"	Volvo	21428532, 21959389, 22307697	ABP N49 V28532



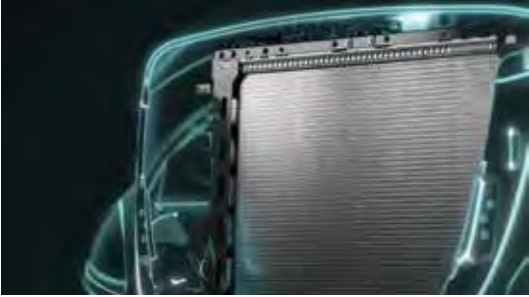

KEEPING IT COOL.

Controlling the temperature of the engine helps to increase your vehicle's performance. Order online at RepairLinkShop.com

PARTS FIT TO PERFORM

fleetrite.com



FLEETRITE® BELTS. SUPER TOUGH. SUPER FLEXIBLE.

Fleetrite's belts are abrasion-, oil-, and chemical resistant making them a quality replacement solution for Original Equipment Manufacturer (OEM) and heavy-duty applications. Suitable for many makes and models of vehicles, Fleetrite belts keep your vehicles running.

PARTS FIT TO PERFORM

fleetrite.com



SURGE TANKS



INTERNATIONAL				
PN	DESCRIPTION	APPLICATION	MODINE X-REF	FLEETRITE X-REF
2508124C3	Deaeration Radiator Surge Tank	International 7600, 7700	—	—
2510603C92	Radiator Surge Tank	International 7300, ProStar®	—	—
2591620C91	Radiator Surge Tank	International 5900, 8600, 9200, 9400, 9900, ProStar®	—	FLTOT2591620
2591802C1	Deaeration Surge Tank	International 7300, 7400, 7500	—	FLTOT2591802
2594380C1	Deaeration Surge Tank	International 7300, 7400, 7600, 7700, HV	5S07226	—
2602871C91	Radiator Surge Tank	International; IC Bus; Ford 1300, 3200, 4100, 4200, 4300, 4400, BE, CE, F650, F650, HV, MV	1S316092	—
2602872C91	2-Port Homopol Radiator Surge Tank	International; IC Bus; Ford 1300, 3200, 4100, 4200, 4300, 4400, 7300, 8500, BE, CE, F650, F750, MV	1S316093	FLTOT2602872
2602935C91	Radiator Surge Tank with Hose Clamp	International; IC Bus; Ford 1300, 3200, 3300, 4100, 4200, 4300, 4400, 8500, BE, CE, F650, F750	1S31609	FLTOT2602935
2602943C91	Dual Radiator Surge Tank	International, 4200, 4300, 4400	1S316091	FLTOT2602943
4062312C1	Radiator Surge Tank	International, HV, HX, LT, RH	—	—
4062314C1	Radiator Surge Tank Cooling System	International, HV, HX, LT, RH	—	—



FLEETRITE						
PN	DESCRIPTION	APPLICATION	INTERNATIONAL X-REF	DORMAN X-REF	AUTOMANN X-REF	SPECTRA X-REF
FLTOT2508700	Radiator Surge Tank	International 9200, 9400, 9800, 9900	2508700C93	603-5103	575.1032	FRT35-2C
FLTOT2591620	Radiator Surge Tank	International 9200, 9900, ProStar®	2591620C91	603-5105	—	—
FLTOT2602935	Radiator Surge Tank	International; IC Bus; Ford 1300, 3200, 3300, 4100, 4200, 4300, 4400, 500, BE, CE, F650	2602935C91	603-5110	—	—
FLTOT2602943	Radiator Surge Tank	International 4200, 4300, 4400	2602943C91	603-5104	—	—
FLTOT31002	Radiator Surge Tank	Freightliner M2	—	603-5207	575.1014	FRT1702C
FLTOT63007	Radiator Surge Tank	Freightliner Cascadia, M2	—	603-5203	575.1073	FRT1703C



RADIATORS



INTERNATIONAL

PN	APPLICATION	FLEETRITE X-REF	SPI X-REF	NORTHERN X-REF
2516108C91	HV, HX, LT, RH	—	—	—
2593295C92	4100, 4200, 4300, 4400, BE/CE, F650, F750, HV, MV, RXT	FLTRDFINT0817	SPI20013534	—
2516107C91	HV, HX, LT, RH	—	—	—
2591560C91	8600, 9200, 9400, 9900, ProStar®	—	—	—
2591559C91	5900, 8600, 9200, 9400, 9900, ProStar®	FLTRIPRO0715	SPI20013533	—
2592331C91	7400, 7500, 7600, 7700, HV	—	—	—
2601809C92	4300, 4400, 7300, 7400, 7500, HV, MV	—	—	—
2604461C94	7600	—	—	—
2504903C92	4100, 4200, 4300, 4400, BE/CE/FE, F650, F750, RXT	FLTRFINT0208	SPI20013532	239329
2591827C91	7300, 7400, 7500, CXT	FLTRI7307400	—	239092
2593283C92	4100, 4200, 4300, 4400, BE/CE, F650, F750, HV, MV, RXT	FLTRDFINT0817	—	—
2604297C92	8600, HX, ProStar®	—	—	—
2586330C93	4400, 8200, 8300, 9200, 9300, 9400	FLTRI9109307	—	239349
2604117C92	7300, 7400, 7500, HV	—	—	—
2605069C91	7300, 7400, 7500	—	—	—
2604119C92	7300, 7400, 7500, HV	—	—	—
2586042C91	7300i, 7400, 7500	FLTRI7307600	—	239289
2591828C91	7300, 7400, 7500	—	—	—
2504905C92	3300, 4100, 4200, 4300, 4400, FBC, F650, F750, SFC	FLTRF0650750	—	—
2601807C92	DuraStar® 4400	FLTRICBS4143	—	238704
2593302C92	4300, 4400, 8500, 9600, 9700, RXT	FLTRI4409600	—	—
2604145C91	7300, 7400, 7500	—	—	—



FLEETRITE

PN	APPLICATION	INTERNATIONAL X-REF	SPI X-REF	NORTHERN X-REF
FLTRFM180813	Freightliner M2 106	—	SPI20011743	—
FLTRDFINT0817	4100, 4200, 4300, 4400, BE/CE, F650, F750, HV, MV, RXT	2593295C92	SPI20013546	—
FLTRIPRO0715	5900, 8600, 9200, 9400, 9900, ProStar®	2591559C91	SPI20013533	—
FLTRFCAS1213	Freightliner Cascadia, M2 112; Western Star 5700XE	—	SPI20011738	—
FLTRI9109307	4400, 8200, 8300, 9200, 9300, 9400	2586330C91	—	239349
FLTRI91009307	5500, 7400, 7500, 8200, 9200	2024380C92	2001-3503	—
FLTRI92000307	8600, 9200i, 9400i, 9900i, 9900ix	2588057C91	—	—
FLTRFINT0208	4100, 4200, 4300, 4400, BE/CE/FE, F650, F750, RXT	2504903C91	2001-3531	239329
FLTRI3809402	3600, 3800	1697273C3	2006-3506	238520
FLTRF1060809	Freightliner Sterling M2 106; Acterra	—	SPI20011744	239087
FLTRI7307400	WorkStar® 7300, 7400, 7500, 7600, 7700	2591827C91	—	239092
FLTRI7307600	7300i, 7400, 7500	2586042C91	2001-3509	239289
FLTRICBS4143	DuraStar® 4400	2601807C92	SPI20013537	238704
FLTRI4909404	3600, 3800, 4700, 4700LP, 4700LPX, 4800, 4900	2502718C2	SPI20063505A	238575



RADIATORS (CONT'D)



SPECTRA PREMIUM				
PN	APPLICATION	FLEETRITE X-REF	NORTHERN X-REF	INTERNATIONAL X-REF
SPI20013503	5500, 7400, 7500, 8200, 9200	FLTRI91009307	—	2024380C92
SPI20013533	5900, 8600, 9200, 9400, 9900, ProStar®	FLTRIPRO0715	—	2591559C91
SPI20063505A	3600, 3800, 4700, 4700LP, 4700LPX, 4800, 4900	FLTRI4909404	238575	2502718C2
SPI20013550	WorkStar® 7300, 7400, 7500, 7600, 7700	FLTRIWRK1013	—	—
SPI20013527	DuraStar® 4400	FLTRICBS4143	238704	2601807C92
SPI20011738	Freightliner Cascadia M2 112; Western Star 5700XE	FLTRFCAS1213	—	—



CHARGE AIR COOLERS



INTERNATIONAL			
PN	APPLICATION	FLEETRITE X-REF	SPI X-REF
2591600C91	8600, 9200, 9400, 9900, NC2, ProStar®	FLTCCIPROSTR2	SPI44013511
2613050C91	3200, 4200, 4300, 4400, 7300, 8500, BE20, CACB, FBTC, HVMD, ICCB, ICSB, J650, J750, MV, RXT	FLTCCIDURSTAR	SPI44013512
2522477C91	7300, 7400, 7500, 7600, 7700, CXT, HV	FLTCCIWKSTR3	SPI44013517
2604156C91	7300, 7400, 7500	—	—
2613048C91	4100, 4200, 4300, CACB, ICCB, ICSB	FLTCCI44001415	—
2596587C91	8600, 9200, 9400, 9900, APRO, NC2, PRO, PROL, PROP	FLTCCI869200	—
2613047C91	4300, 4400, 7300, 7400, 7500, HVMD, MV	FLTCCIDSTAR2	—
2604455C92	7600	FLTCCIWKSTR1	—
2586790C1	3200, 3300, 4300, 4400, CACB, ICCB, ICSB, FBCB, FBTC, RXT, SFCB	FLTCCFINT0207	—
2514281C1	7600	—	—
2523398C91	LoneStar®	—	—
2613049C91	4300, 7300, CACB, ICCB, ICSB	—	—
2518194C91	HX, ProStar®	FLTCCIPROSTAR	—
2586044C1	7300, 7400, 7500, CXT	FLTCCI730509	SPI44013513
2512143C91	5900, 9900, HX	—	—
1696920C2	3047, 3600, 3800, 4700, 4800, 4900	FLTCCFM21116	—
2504904C1	3200, 4300, 4400, 8500, FBCB, ICCB, ICSB, J650, J750, SFCB	FLTCCFINT0207	SPI44013509



Fleetrite® Radiators – a Variety of Configurations

Fleetrite radiators are available in a variety of configurations and applications. Many models are available in both all-metal and plastic/aluminum materials. The all-metal radiators have a patented welded tube to header joints where needed for extra strength and support, and are 100% leak tested.

fleetrite.com



CHARGE AIR COOLERS (CONT'D)



FLEETRITE			
PN	APPLICATION	INTERNATIONAL X-REF	SPI X-REF
FLTCCIPROSTR2	8600, 9200, 9400, 9900, NC2, PRO, PROL, PROP	2591600C91	SPI44013511
FLTCCIWKSTR3	7300, 7400, 7500, 7600, 7700, CXT, HVMD, MIL, MIL1	2592337C91	SPI44013517
FLTCCI86940407	8600 SBA, 9200i SBA, 9400i SBA, 9900i, 9900ix, 9900ix SFA	2586894C91	SPI44013508
FLTCCIDURSTAR	3200, 4200, 4300, 4400, 7300, 8500, BE20, CACB, FBTC, HVMD, ICCB, ICSB, J650, J750, MV, RXT	2613050C91	SPI44013512
FLTCCIDSTAR2	4300, 4400, 7300, 7400, 7500, HVMD, MV	2613047C91	—
FLTCCI44001415	4100, 4200, 4300, CACB, ICCB, ICSB	2613048C91	—
FLTCCIPROSTAR	HX, ProStar®	2518194C91	—
FLTCCI9409300	5500, 8200, 9000	2005432C1	SPI44013501
FLTCCIWKSTR1	7600	2604455C92	—
FLTCCFINT0207	3200, 4300, 4400, 8500, FBCB, ICCB, ICSB, J650, J750, SFCB	2504904C1	SPI44013509
FLTCCI730509	7300, 7400, 7500, CXT	2586044C1	SPI44013513

SPECTRA PREMIUM			
PN	APPLICATION	FLEETRITE X-REF	INTERNATIONAL X-REF
SPI44013512	3200, 4200, 4300, 4400, 7300, 8500, BE20, CACB, FBTC, HVMD, ICCB, ICSB, J650, J750, MV, RXT	FLTCCIDURSTAR	2613050C91
SPI44013517	7300, 7400, 7500, 7600, 7700, CXT, HVMD	FLTCCIWKSTR3	2592337C91



FANS



INTERNATIONAL		
PN	DESCRIPTION	FLEETRITE X-REF
3625639C1	Engine Cooling Fan, 32" Diameter, 2.56" Pilot	FLT456001
3809753C2	Engine Cooling Fan, 32" Diameter, 2.56" Pilot	FLT461001
3681266C1	Engine Cooling Fan, 32" Diameter, 5" Pilot	—
3677579C1	Engine Cooling Fan, 32" Diameter, 5" Pilot	—
2517027C1	Engine Cooling Fan, 28" Diameter, 5" Pilot	—
4093137C1	Engine Cooling Fan, 27" Diameter, 5" Pilot	—

FLEETRITE				
PN	DESCRIPTION	INTERNATIONAL X-REF	FREIGHTLINER X-REF	BORGWARNER X-REF
FLT456001	9 Blade, 32" Diameter, 2.56" Pilot	3625639C1	—	—
FLT139316	9 Blade, 30" Diameter, 5" Pilot	—	05-17926-500	—
FLT4139301	9 Blade, 30" Diameter, 2.56" Pilot	—	05-17926-256	—
FLT461001	11 Blade, 32" Diameter, 2.56" Pilot, 2.2" Dish	3809753C2	—	—
FLT4400312	11 Blade, 32" Diameter, 2.56" Pilot, 1.41" Dish	—	—	10011604



Fleetrite® Charge Air Coolers Made for Better Fuel Efficiency

Fleetrite charge air coolers are made from industrial-grade alloy, furnace-brazed aluminum. Each Fleetrite Charge Air Cooler comes with a 2-year warranty when installed at an authorized International dealer. For better fuel efficiency, less wear and tear on the turbo and engine, the Fleetrite Charge Air Coolers have a zero acceptable leak-down ratio.

fleetrite.com



FAN DRIVES



INTERNATIONAL

PN	DESCRIPTION	HORTON X-REF	FLEETRITE X-REF
3609117C3	Viscous Fan Drive, Model 805	—	—
4045105C1	Fan Clutch	—	—
3696123C91	Air Fan Drive	—	FLT8001N
2514343C91	K32 Fan Clutch	HOR9908501	FLT8901N
3584438C4	Viscous Fan Drive, SA85 Spin On	HOR9902013	FLT061040003
2601975C1	Fan Drive	—	FLT021090000
2602193C1	Viscous Fan Drive, SA75	—	FLT021090000
3540116C5	Fan Drive	—	—
5010978R1	Remanufactured, Stratis Fan Drive	—	—



FLEETRITE

PN	DESCRIPTION	HORTON X-REF	INTERNATIONAL X-REF	BORGWARNER X-REF
FLT8901N	Rear Air Fan Clutch, Kysor Style, 2.56", Pilot	—	2514343C91	1090-08500-01
FLT8905N	Rear Air Fan Clutch, Kysor Style, 5", Pilot	—	—	1090-09750-01
FLT021090000	Viscous Fan Drive, SA75	—	2602193C1	10020755
FLT061040003	Viscous Fan Drive, SA85 Spin On	HOR9902013	3584438C4	—
FLT24256	2-Speed Fan Clutch Rebuild Kit, 2.56"/5", Pilot	—	—	—
FLT14256	Fan Clutch Rebuild Kit, 2.56", Pilot, Spring Engaged	—	—	—
FLT061050000	Viscous Fan Drive	—	—	—
FLT9500HP	Fan Clutch Rebuild Kit, HT/S Series	HOR601158	—	—
FLT031110000	Viscous Fan Clutch	—	—	10020509
FLT8001N	Fan Clutch, K32 FA Kysor-Style	—	—	1090-05262-01
FLT858101	Fan Clutch Bearing Kit	—	10330778101	—
FLT244700	Fan Clutch Riser Plate	—	—	—
FLT99188	Fan Clutch	HOR799188	—	—
FLT8801N48	Fan Clutch	—	—	—
FLT14S	Fan Clutch Seal Kit	—	—	—
FLTFD894305	Fan Clutch Seal Kit	—	—	—
FLT041010000	Viscous Fan Drive	—	—	10019721
FLT998332	2-Speed Fan Clutch	HOR99A9750	6101420C91	—
FLT2425648	2-Speed Fan Clutch Rebuild Kit, 2.56", Pilot	—	—	—
FLT071040003	Viscous Fan Drive	—	—	10021288
FLT021090000	Viscous Fan Drive	—	—	10020755
FLT99649	Fan Clutch, Remanufactured Style, Conversion from Medium-Duty	HOR79A9649	—	—



HORTON

PN	DESCRIPTION	APPLICATION	X-REF
HOR9908504	Clutch, Rear Air, K32, Dual Pilot	—	2602141C91, 2509380C91, 2514343C91
HOR995547	Kit, PolarForce, 5.00 Pilot, 27.1 Studs	—	—
HOR99A4700	Clutch Pack, DM2S, Modular	School Bus; WorkStar®, DuraStar®; Cummins ISB, ISL-G 2013 – 2016	—
HOR99A4700	Clutch Pack, DM2S, Modular	4400, 4000 Series, School Bus, Rear Engine Bus, 7300, 7400, 7500, MD LOW CAB/CE BUS, MD MID CAB/RH, WorkStar®, DuraStar®, 4300 International, I6-DT466, MaxxForce® DT, 9, 10, DT466 2006 – 2015	—
HOR99A4700	Clutch Pack, DM2S, Modular	LoadStar®, International MaxxForce® 10, 11 2012 – 2014	—
HOR99A4701	Clutch Pack, DM2S, Modular	TranStar®, Rear Engine Bus International, I6-DT466, DT466E, DT466, DT530, INT530 2004 – 2007	—
HOR99A4701	Clutch Pack, DM2S, Modular	DuraStar®, International MaxxForce®, DT Natural Gas 2007 – 2011	—
HOR99A4706	Clutch Pack, DM2S, Modular	ProStar®, International MaxxForce® 11, 13, N13 2007 – 2016	—
HOR99A4706	Clutch Pack, DM2S, Modular	RH613, International A26, LH, RH 2017 – 2021	—
HOR99A9263	Clutch, DMADV SE 21, CUM, 211.4, 8-K, 65.0 Pilot, 20.7 Studs	8600, Cummins ISM 2002 – 2005	—



FAN DRIVES (CONT'D)



HORTON (CONT'D)

PN	DESCRIPTION	APPLICATION	X-REF
HOR99A9743	Clutch, DMA2S, INT, 231.0, 126.9 Pilot, 26.6 Studs	7300, 7400, 7500, WorkStar® International, MaxxForce® 9, 10, MaxxForce® DT, 1344 2010 – 2013	—
HOR99A9757	Clutch, DMA2S, INT, 212.2, 8PK, 126.9 Pilot, 26.6 Studs	7600, 7700, WorkStar® International, MaxxForce® 11, MaxxForce® 13, N13 2010 – 2013	—
HOR993605	Switch, Thermal, NC, 195 F	—	—
HOR993653	Switch, Thermal, NC, 195 F	—	—
HOR993762503	Fan, 762, CW, Plastic, 92.2WD, 127.0ID, 152.4BC, BK	—	—
HOR1SDP	Fan Clutch Repair Kit, On/Off	—	—
HOR2SDP	Fan Clutch Repair Kit, 2-Speed	—	—
HOR79A7618	Sheave Assembly Remanufactured, 201.2 OD, DMA	School Bus, Rear Engine Bus, 7300, 7400, 7500, MD LOW CAB/CE BUS, 4300 International, DT466E, DT570, MaxxForce® DT, DT466 2007 – 2009	—
HOR79A7618	Sheave Assembly Remanufactured, 201.2 OD, DMA	DuraStar®, 4300 International, MaxxForce® DT 2010 – 2012	—
HOR79A7619	Sheave Assembly Remanufactured, 219.4 OD, DMA	4400, School Bus, Rear Engine Bus, 7300, 7400, 7500, MD LOW CAB/CE BUS, MD MID CAB/RH, International I6-DT466, DT570, MaxxForce® DT, DT466 2007 – 2009	—
HOR79A7619	Sheave Assembly Remanufactured, 219.4 OD, DMA	WorkStar®, DuraStar®, International, MaxxForce® DT 2011 – 2016	—
HOR79A82402	Remanufactured, 2-Speed SE 24, CUM, 183.6, 65.0 Pilot, 20.7 Studs	ProStar®, Cummins ISX15, X15 2017 – 2020	98218-2
HOR79A82402	Remanufactured, 2-Speed SE 24, CUM, 183.6, 65.0 Pilot, 20.7 Studs	LT, LT 625, Cummins ISX15, X15 2018 – 2022	98218-2
HOR79A8240	Remanufactured, On/Off Fan Drive 24, CUM, 183.6, 65.0 Pilot, 20.7 Studs	ProStar®, Cummins ISX15, X15 2017 – 2020	98218
HOR79A8240	Remanufactured, On/Off Fan Drive DMA SE 24, CUM, 183.6, 65.0 Pilot, 20.7 Studs	LT, LT 625, Cummins ISX15, X15 2018 – 2022	98218



BELTS



SERPENTINE BELTS—GROOVE 6

TOP WIDTH	EFFECTIVE LENGTH IN INCHES	RIBS	FLEETRITE X-REF	GATES X-REF	TRP X-REF	CONTINENTAL X-REF	DAYCO X-REF	OTHER X-REF
0.81"	37.4"	6	—	K060374	—	4060374	5060374	D84-1000-6060950
0.81"	42.3"	6	—	K060423	423K6BLT	4060423	5060423	3076492
0.81"	47"	6	FLTBT470K6	K060470HD	470K6BLT	4060470	5060470	3515596C1
0.81"	48.8"	6	—	K060490HD	488K6BLT	4060488	5060490	2513517C1
0.81"	51"	6	FLTBT510K6	K060509	510K6BLT	4060510	5060510	1843218C1
0.81"	51.6"	6	FLTBT515K6	K060516	515K6BLT	4060515	5060515	3401283, 2513527C1, D84-1000-3061310
0.81"	52.8"	6	FLTBT528K6	K060529	528K6BLT	4060528	5060530	D84-1000-3061340
0.81"	53.7"	6	FLTBT537K6	K060535	537K6BLT	4060537	5060538	—
0.81"	54"	6	—	K060539	540K6BLT	4060539	5060540	4004824, D84-1000-3061370
0.81"	56"	6	FLTBT560K6	K060560	560K6BLT	4060560	5060560	—
0.81"	56.7"	6	—	K060568HD	567K6BLT	4060567	5060570	D84-1000-3061440
0.81"	60.4"	6	FLTBT605K6	K060604	605K6BLT	4060605	5060605	3565414C1, D84-1000-9061535
0.81"	60.9"	6	—	K060609	—	4060610	5060610	D84-1000-9061547
0.81"	63.2"	6	—	K060630	—	4060630	5060630	3682687, 3999452C1



Air Pressure Check for Pneumatic Fan Clutch

Air pressure is critical to the operation of a pneumatic fan clutch, and minimum of 90 psi is required for it to fully disengage. When system pressure falls below 90 psi, excessive friction results, and the life expectancy of the fan clutch is significantly reduced. An air pressure check can be conducted between the solenoid valve and the fan clutch. To improve uptime, this test should be added to a 25k to 50k mile PM schedule.

hortonww.com

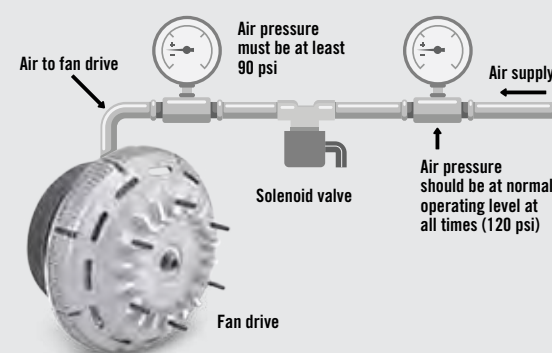

BELTS (CONT'D)



SERPENTINE BELTS—GROOVE 6 (CONT'D)

TOP WIDTH	EFFECTIVE LENGTH IN INCHES	RIBS	FLEETRITE X-REF	GATES X-REF	TRP X-REF	CONTINENTAL X-REF	DAYCO X-REF	OTHER X-REF
0.81"	63.8"	6	FLTBT638K6	K060637	638K6BLT	4060638	5060640	3682684, 2513523C1, D84-1000-3061620, D84-1000-6061620
0.81"	68.9"	6	—	K060690	690K6BLT	4060690	5060690	D84-1000-6061750
0.81"	69.6"	6	FLTBT695K6	K060696	695K6BLT	4060695	5060695	1847509C1
0.81"	73.6"	6	—	K060736HD	735K6BLT	4060735	5060735, 5060738	D84-1000-6061870
0.81"	85.6"	6	—	K060858	855K6BLT	4060858	5060858	1888570C1, D84-1000-6062175

SERPENTINE BELTS—GROOVE 7-12

TOP WIDTH	EFFECTIVE LENGTH IN INCHES	RIBS	FLEETRITE X-REF	GATES X-REF	TRP X-REF	CONTINENTAL X-REF	DAYCO X-REF	OTHER X-REF
0.95"	76.3"	7	—	K070763	763K7BLT	4070762F	5070763	D84-1002-071939
1.1"	64.5"	8	—	K080645	—	4080645	5080645	4942430
1.1"	68.3"	8	FLTBT685K8	K080683HD	685K8BLT	4080685	5080685	3289213, 3289224, 1830729C2, D84-1000-6081735
1.1"	69.3"	8	FLTBT695K8	K080694	695K8BLT	4080695	5080695	3289257, 3289941, 2513524C1
1.1"	70"	8	FLTBT700K8	K080700	700K8BLT	4080700	5080700	3289279, 2513520C1, D84-1000-6081780
1.1"	71"	8	FLTBT710K8	K080710	710K8BLT	4080710	5080710	3289347, 1819392C2, D84-1000-3081803
1.1"	71.9"	8	FLTBT720K8	K080720	720K8BLT	4080720	5080720	3289448, 2513519C1
1.1"	72.4"	8	FLTBT725K8	K080726	725K8BLT	4080725	5080725	3289503, 1842455C1, 2513518C1
1.1"	72.8"	8	FLTBT730K8	K080730	730K8BLT	4080728	5080730	3289514, D84-1000-6081850
1.1"	74"	8	FLTBT740K8	K080740	740K8BLT	4080740	5080740	3288461, 2513525C1, D84-1000-3081880
1.1"	76"	8	FLTBT760K8	K080760	760K8BLT	4080760	5080760	3972261, D84-1000-6081930
1.1"	76.4"	8	—	K080765	765K8BLT	4080765	5080765	D84-1000-6081940
1.1"	79.3"	8	FLTBT797K8	K080794HD	797K8BLT	4080793	5080795	3972384, 3664150C1
1.1"	80.3"	8	FLTBT805K8	K080803	805K8BLT	4080803	5080805	3972383, 3974247, 2513526C1
1.1"	81.8"	8	FLTBT815K8	K080816HD	815K8BLT	4080817	5080815	3967026, 3972382, D84-1003-082078
1.1"	82.5"	8	FLTBT825K8	K080825	825K8BLT	4080825	5080825	3289864, 3289853, 2513522C1
1.1"	83"	8	FLTBT830K8	K080830	830K8BLT	4080830	5080830	3972263, 3866104C1
1.1"	84.3"	8	—	K080842	845K8BLT	4080845	5080845	3974249, D84-1000-6082140
1.1"	85.6"	8	FLTBT855K8	K080855	855K8BLT	4080856	5080855	3289974, 3972376, D84-1000-6082175
1.1"	91.4"	8	—	K080915	915K8BLT	4080917	5080915	3571272C2, D84-1003-082322
1.1"	92.5"	8	FLTBT925K8	K080926	925K8BLT	4080925	5080925	1842461C1
1.1"	93.1"	8	—	K080931HD	—	4080932	5080933	3972381, D84-1000-7082365
1.1"	94.9"	8	—	K080948	—	4080948	—	3978284
1.1"	95.3"	8	FLTBT952K8	K080952	952K8BLT	4080953	5080953	1842468C1, D84-1000-3082420, D84-1000-6082420
1.1"	99.2"	8	FLTBT992K8	K080991	992K8BLT	4080992	5080993	3972381, D84-1000-3082520, D84-1000-6082520
1.1"	102"	8	FLTBT1020K8	K081020	1020K8BLT	4081020	5081020	D84-1000-3082590, D84-1000-6082590
1.1"	102.4"	8	—	K081023	1024K8BLT	4081024	5081025	D84-1000-3082600, D84-1000-6082600
1.1"	104.7"	8	—	K081047HD	—	—	5081050	1889037C1
1.1"	112.4"	8	FLTBT1124K8	K081124	1124K8BLT	4081124	5081125	1822832C1

BELTS (CONT'D)



SERPENTINE BELTS—GROOVE 7-12 (CONT'D)

TOP WIDTH	EFFECTIVE LENGTH IN INCHES	RIBS	FLEETRITE X-REF	GATES X-REF	TRP X-REF	CONTINENTAL X-REF	DAYCO X-REF	OTHER X-REF
1.4"	46.7"	10	—	K100467A	—	—	—	D84-1003-101187
1.4"	56.3"	10	—	K100564HD	—	4100565	5100565	SZ91045377
1.4"	58.7"	10	—	K100586	—	4100585	5100585	7096086C1
1.4"	85.3"	10	—	K100852	—	—	5100855	—
1.4"	86"	10	—	K100860HD	860K10BLT	4100860	5100860	1847707C1
1.4"	86.4"	10	—	K100864HD	864K10BLT	4100865	5100864	1847701C1
1.4"	87"	10	—	K100870HD	870K10BLT	4100870	5100870	1847708C1
1.4"	87.4"	10	—	K100874HD	874K10BLT	4100875	5100874	D84-1000-6102220
1.4"	93.5"	10	—	K100935HD	—	4100935	5100935	D84-1000-6102375
1.4"	94.7"	10	—	K100946HD	947K10BLT	4100947	5100948	D84-1000-6102405
1.4"	98.2"	10	FLTBT983K10	K100983HD	983K10BLT	4100983	5100983	1847748C1
1.65"	47.7"	12	—	K120476HD	—	4120476F	5120477	D84-1003-121212
1.65"	48.3"	12	—	K120483HD	—	4120483	5120483	D84-1002-121228
1.65"	57"	12	—	—	—	4120570	5120570	D84-1003-121448
1.65"	64.6"	12	—	K120645HD	646K12BLT	4120645F	5120646	D84-1002-121640
1.65"	84.2"	12	FLTBT842K12	K120842	842K12BLT	4120842	5120843	20481362, 3682891
1.65"	85.2"	12	—	K120852HD	—	4120851F	5120852	4019203C1
1.65"	85.8"	12	FLTBT858K12	K120858HD	858K12BLT	4120858	5120858	D84-1000-6122180
1.65"	87"	12	—	K120870HD	870K12BLT	4120872	5120870	2513528C1
1.65"	87.2"	12	FLTBT872K12	K120872	872K12BLT	4120872	5120873	D84-1000-6122215
1.65"	89"	12	—	K120891	—	4120890	—	D84-1000-3122260, D84-1000-6122260
1.65"	90.4"	12	—	K120903	—	4120904	5120903	3100189, D84-1000-3122295, D84-1000-6122295
1.65"	90.9"	12	FLTBT910K12	K120910HD	910K12BLT	4120910	5120910	3565410C3, D84-1000-6122310
1.65"	98"	12	FLTBT980K12	K120980HD	980K12BLT	4120980	5120980	3565411C1, D84-1000-6122490
1.65"	98.4"	12	—	K120985HD	985K12BLT	4120984	5120985	D84-1000-3122500
1.65"	103.9"	12	FLTBT1040K12	K121039	1040K12BLT	4121039	5121040	D84-1000-3122640
1.65"	104.9"	12	FLTBT1049K12	K121049HD	1049K12BLT	4121049	5121050	D84-1000-6122665
1.65"	112.6"	12	—	K121124HD	1126K12BLT	4121126	5121128	D84-1000-3122860



V-BELTS

TOP WIDTH	EFFECTIVE LENGTH IN INCHES	FLEETRITE X-REF	GATES X-REF	TRP X-REF	CONTINENTAL X-REF	DAYCO X-REF
0.47"	30.5"	FLTBT17305	9305	17305BLT	17305	17305
0.47"	39"	FLTBT17390	9390	17390BLT	17391	17390
0.47"	39.5"	FLTBT17395	9395	17395BLT	17395	17395
0.47"	40"	FLTBT17405	9405	17405BLT	17405	17405
0.47"	41.5"	FLTBT17415	9415	17415BLT	17415	17415
0.47"	42"	FLTBT17420	9420	17420BLT	17421	17420
0.47"	44.5"	FLTBT17445	9447	17445BLT	17446	17443
0.47"	45"	FLTBT17450	9451	17450BLT	17451	17448
0.47"	45.5"	FLTBT17455	9455	17455BLT	17456	17455
0.47"	46"	FLTBT17460	9463	17460BLT	17461	17460
0.47"	49.5"	FLTBT17495	9495	17495BLT	17494	17495
0.47"	53.5"	FLTBT17530	9530	17535BLT	17535	17530
0.47"	54.5"	FLTBT17544	9545	17544BLT	17544	17540
0.47"	57"	FLTBT17570	9570	17570BLT	17570	17570
0.47"	59"	FLTBT17590	9590	17590BLT	17591	17590
0.47"	61.5"	FLTBT17615	—	17615BLT	17615	17615
0.69"	49.5"	FLTBT22490	TR22495	22495BLT	22494	22495
0.69"	53.5"	FLTBT22540	TR22534	22534BLT	22534	22528
0.69"	54.5"	FLTBT22544	—	22544BLT	22544	22535
0.69"	55"	FLTBT22550	TR22545	22550BLT	22550	22545
0.69"	57"	FLTBT22574	TR22570	22570BLT	22570	22570
0.88"	47.5"	FLTBT28477	TR28473	28477BLT	28477	28473
0.88"	48"	FLTBT28483	TR28483	28483BLT	28483	28480





USING REMAN PARTS IS LIKE BRINGING **SAVINGS** ALONG WITH YOU.

At Horton, we know that uptime is money. We also know that when you need a quality part you can trust, we want to save you hassle and keep you from breaking the bank. Exactly why we have a vast array of reman parts that are quality manufactured to spec. We also have a QuickShip Warehouse program to get you parts and get you back on the road—and fast. With Horton you know you're riding with the global leader in optimizing cooling systems for heavy, medium and light-duty trucks, buses, RV's, refuse vehicles and more.



To learn more, find your rep here:

<https://www.hortonww.com/contact-landing/sales-rep-finder.html>

Or email info@hortonww.com



FLEETRITE® FIFTH WHEEL.

Replace the inside components without the hassle of the top plate.

Order online at RepairLinkShop.com

PARTS FIT TO PERFORM

fleetrите.com



THE FONTAINE® APP MAKES IT EASY!

Did you know that you can type in a Fontaine Fifth Wheel serial number under "Search Parts" and you will see all the part kits for that specific model? If you enter a competitive fifth wheel part number you will see the Fontaine Complete Assembly cross reference. Select complete assemblies are about the same price as a top plate to make switching to Fontaine an attractive option. Available free from Apple/Google Play.

fifthwheel.com



FIFTH WHEEL



FONTAINE ASSEMBLIES

PN	DESCRIPTION	APPLICATION
SL6PML6250	6000 Series Standard-Duty Complete Assembly, includes No-Slack® Stamped Steel Top Plate, Stationary 6.25" Bracket Height	Universal Fit, Bolts to Out-Board Angles
SL6PML7250	6000 Series Standard-Duty Complete Assembly, includes No-Slack® Stamped Steel Top Plate, Stationary 7.25" Bracket Height	Universal Fit, Bolts to Out-Board Angles
SL6LWB675024	6000 Series Standard-Duty Complete Assembly, includes No-Slack® Stamped Steel Top Plate, 6.75" Bracket Height, 24" Slide Travel	Universal Fit, Bolts to Out-Board Angles
SL7LWB675024	7000 Series Moderate-Duty Complete Assembly, includes No-Slack® Cast Top Plate, 6.75" Bracket Height, 24" Slide Travel	Universal Fit, Bolts to Out-Board Angles
SL7LWB725024	7000 Series Moderate-Duty Complete Assembly, includes No-Slack® Cast Top Plate, 7.25" Bracket Height, 24" Slide Travel	Universal Fit, Bolts to Out-Board Angles
SL7LWB825024	7000 Series Moderate-Duty Complete Assembly, includes No-Slack® Cast Top Plate, 8.25" Bracket Height, 24" Slide Travel	Universal Fit, Bolts to Out-Board Angles
SL7LWB925024	7000 Series Moderate-Duty Complete Assembly, includes No-Slack® Cast Top Plate, 9.25" Bracket Height, 24" Slide Travel	Universal Fit, Bolts to Out-Board Angles
SLH7NHDS800024	H7 Series Tilt/No-Tilt Complete Assembly, includes No-Slack® Cast Top Plate, 8" Bracket Height, 24" Slide Travel	Universal Fit, Bolts to Out-Board Angles
KITBOLT24	Bolt Kit for Complete Assemblies, for 12", 24" Slide and Stationary Setups, includes 20 Grade 8 Bolts, 20 Grade C Locknuts, 40 Hardened Washers	Universal Fit, Bolts to Out-Board Angles



FONTAINE TOP PLATES

PN	DESCRIPTION	APPLICATION
SLTPL6000	Stay Genuine Fontaine, Stamped Steel Top-Plate 50,000 Vertical Load, 150,000 Drawbar Pull, No-Slack® Lock	Genuine Fontaine Fifth Wheel Brackets
SLTPL7000	Stay Genuine Fontaine, Cast Steel Moderate-Duty Top-Plate 55,000 Vertical Load, 150,000 Drawbar Pull, No-Slack® Lock	Genuine Fontaine Fifth Wheel Brackets
SLTPL7000CC	Cast Steel Moderate-Duty Top-Plate with Clean Connect Low Lube Pads, 55,000 Vertical Load, 150,000 Drawbar Pull, No-Slack® Lock	Genuine Fontaine Fifth Wheel Brackets
SLTPLH7	Cast Steel Heavy-Duty Top-Plate, 68,500 Vertical Load, 180,000 Drawbar Pull, No-Slack® Lock	Genuine Fontaine Fifth Wheel Brackets
AATPL7000	Cast Steel Moderate-Duty Top-Plate with Air Actuated Cab Release, 55,000 Vertical Load, 150,000 Drawbar Pull, No-Slack® Lock	Genuine Fontaine Fifth Wheel Brackets
SLTPLCD700D5	CD700 Custom-Duty Autohauler Top Plate 24", Connects Autohauler Trailers Together, Couples to 2" Kingpin	Genuine Fontaine Fifth Wheel Brackets



Fleetrite® Fifth Wheel Repair Kits Made with Heavy-Duty Materials.

Fleetrite fifth wheel repair kits are manufactured with heavy-duty materials. Excellent fit and quality for trucks with FW35 and FW3510 series fifth wheel assemblies. Replace the inside components without the hassle of the top plate. Contains components needed for repair and maintenance of fifth wheel assemblies.

fleetrite.com



FIFTH WHEEL (CONT'D)



FONTAINE KITS

PN	DESCRIPTION	APPLICATION
KITRPR6000L	Minor Jaw/Wedge Repair Kit, includes Jaw/Wedge and 3 Main Top Plate Springs	Repairs 6000, 7000, UNT Top Plates
KITPUL6000L	Pull Handle Kit, includes Pull Handle and Hardware	Repairs 6000, 7000, UNT Top Plates
KITSPRING	Spring Kit, includes All Three Springs Inside 6000, 7000, UNT Top Plates	Repairs 6000, 7000, UNT Top Plates
KITROD1108	Wedge Stop Rod Kit, for 6000, 7000, UNT, H5092, H7 Top Plates	Repairs 6000, 7000, UNT Top Plates
KITBPR6000L	Bumper Kit, includes Bumper and Hardware	Repairs 6000, 7000, UNT Top Plates
KITLAT6000L	Secondary Lock Kit, includes Secondary Lock and Hardware	Repairs 6000, 7000, UNT Top Plates
KITOPR6000	Operating Handle Kit, includes Operating Handle and Hardware	Repairs 6000, 7000, UNT Top Plates
KITRX67NTL	Major Rebuild Kit, includes All Moving Pieces Inside Top Plate, Rebuilds 6000, 7000, UNT Top Plates	Rebuilds 6000, 7000, UNT Top Plates
KITAA6000L	Replacement Top Plate Cylinder Kit, for Air-Actuated SLTPL6000, AATPL6000 and SLTPL7000, AATPL7000, includes Exhaust Valve JEV-F4M4	6000, 7000, UNT Top Plates
CYLCOMP	Replacement Air Cylinder Kit	For Brackets AWB, ATB
BSH150	1-Piece Bushing Setup, includes Pair of Bushings	Repairs AWB, AWX, MWS, PS5, FMA, HDS Brackets
BSH-LLB	2-Piece Bushing Setup Pair, includes Upper and Lower Bushings and Bracket Liner	Repairs ATB, LWB, NWB, BSL, BSM, PMA, PML Brackets
KITPIN191	1-Piece Pin and Bushing Setup, includes Pair of Bushings and Pins	Repairs AWB, AWX, MWS, PS5, FMA Brackets
KITPINLLB	2-Piece Pin and Bushing Setup Pair, includes Upper and Lower Bushings and Bracket Liner and Pins	Repairs ATB, LWB, NWB, BSL, BSM, PMA, PML Brackets
KITPINUNT	1-Piece Pin and Bushing Setup, includes Pair of Bushings and Pins	Repairs LWO with SLTPLUNT Top Plate



FLEETRITE REPAIR KITS

PN	DESCRIPTION	APPLICATION	HOLLAND X-REF
FLTFWK600262	Fifth Wheel Repair Kit, for FW35 Series Fifth Wheel Assemblies	Universal Fit	RK-351-A-L
FLTFWK600263	Fifth Wheel Repair Kit, for FW3510 Series Fifth Wheel Assemblies	Universal Fit	RK-351-03505



FLEETRITE

BUILT TOUGH AND KEEP COOL.

Fleetrite® compressors and blower motors are built tough and keep cool.

Order online at RepairLinkShop.com

PARTS FIT TO PERFORM

fleetrite.com



repairlink™

YOUR MOST TRUSTED TOOL.

The only VIN catalog in the industry with the ability to search and purchase OEM parts. Order your International® Truck, IC Bus® or all-makes parts at RepairLinkShop.com

PARTS FIT TO PERFORM

repairlinkshop.com



A/C COMPRESSORS



INTERNATIONAL

PN	DESCRIPTION	FLEETRITE X-REF	ALLIANCE X-REF	MEI X-REF	RED DOT X-REF
3863068C4	SD7H15E, 4585U1, PV6, 119mm, 12V	FLTAC2004585	—	54585	—
3628699C4	SD7H15, PV6, 125mm, Tang GWA 2-Wire, 12V	FLTAC2004815AM	ABP N83 304299	5347G	75R81772
4034409C4	QP7H15SHD, PV8, 125mm	FLTAC20QP1934	—	—	—
3808548C4	SD7H15E, 4720, Direct Mount, PV8, 119mm, 12V	FLTAC2004720	—	54720	—
3611894C94	SD7H15, 4347, PV10, 119mm, V-Pad, 12V Enhanced	FLTAC2004347AM	—	—	—
4054729C2	A/C Compressor	—	—	—	—
3792438C4	Sanden Compressor	FLTAC2004107	—	54277	—



FREIGHTLINER

PN	DESCRIPTION	FREIGHTLINER X-REF	ALLIANCE X-REF	MEI X-REF	RED DOT X-REF
FLTAC2022496	10S15C, PV8, 163.5mm, 12V	22-65771-001	ABP N83 304158	5405G	75R9082
FLTAC2022530, FLT1061	10S15C, PV8, 140mm, 12V	22-65770-001	—	5405A	—
FLTAC2022529	10S15C, PV6, 157mm, 12V	22-65772-001	—	—	—
FLTAC2004485, FLT4417QS	SD7H15, PV8, 119mm, Direct Mount, GH Head, 12V	SKI4417	ABP N83 304003	5333	75R81302
FLTAC2004314AM	SD7H15SHD 4314, PV8, 119mm, Vertical Pad, 90 Degree, 12V	SKI4615	—	5395Q	75R90992A
FLTAC2004802AM	SD7H15SHD 4314, PV8, 119mm, Vertical Pad, 90 Degree, 12V	SKI4802S	N83 304QP7H154802S	5398G	—
FLTAC2022496AM	10S15C, PV8, 163.5mm, 12V	22-6577-00	ABP N83 304158	5405G	75R9082



KENWORTH AND PETERBILT

PN	DESCRIPTION	KENWORTH AND PETERBILT X-REF	ALLIANCE X-REF	MEI X-REF	RED DOT X-REF
FLTAC2004484	SD7H15, 125mm, 2A, VOR, JDA, Head Ear, 12V	18-04088	—	5363	—
FLTAC2009978	SD7H15, EAR, VOR, 132mm, 2A, LS, 2-Wire Diode, 12V	18-03787	—	—	—
FLTAC2004041	SD7H15, 4041, 2AG, 125mm, GQ Head, 12V	F69-6002-231	—	5373	—
FLTAC2004577	SD7H15SPRHD, 4577, PV7, 126mm, WX, Rear Head, 12V	F69-1013	ABP N83 304143	54577	75R8772



MACK AND VOLVO

PN	DESCRIPTION	MACK AND VOLVO X-REF	ALLIANCE X-REF	MEI X-REF	RED DOT X-REF
FLTAC2010068	SD7H15HD, 4664, EAR, VOR, 132mm, 2A, 3E, 1-Wire, 12V	206RD413M	ABP N83 304363Q	5764	75R8412
FLTAC2004494	SD7H15, 4891, PV6, Direct Mount, WV Head, 12V	8088112	ABP N83 304624	5387	75R81372



UNIVERSAL

PN	DESCRIPTION
FLTAC2010330AM	HVAC Compressor, ET210L Model, Direct Mount, Tube-O Port



A/C CONDENSERS



INTERNATIONAL

PN	DESCRIPTION	FLEETRITE X-REF	ALLIANCE X-REF	MEI X-REF	RED DOT X-REF
2591836C93	International 4000-9000 Series 2007 - 2008	FLTAC2450521	ABP N83 306335	6372G	77R7705
2593329C93	International ProStar® 8000 Series 2008 - 2010	FLTAC2451207	—	6378G	—
2591621C94	International 4000-9000 Series 2007 - 2008	FLTAC2450521	ABP N83 306335	6372G	77R7705
2586812C94	International 4200, 4300, 4400, 8500 2001 - 2006	FLTAC2430536	—	6288G	—
2507482C95	International 7100 Series 2001 - 2006	FLTAC2450527	—	6300G	—
2000655C1	International 4900 Series 1993 - 2000	FLTAC2450532	—	6227G	—
2586812C94	International 4200, 4300, 4400, 8500 2001 - 2006	FLTAC2430536	—	6288G	—



FREIGHTLINER

PN	DESCRIPTION	FREIGHTLINER X-REF	ALLIANCE X-REF	MEI X-REF	RED DOT X-REF
FLTAC2433651	Freightliner 2008 - 2015	A22-67125-000	N83-306032	6319G	77R2177
FLTAC2450318	Freightliner, Sterling	1E5864	N83-306027	6297G	77R6978
FLTAC2433651	Freightliner, Sterling	A22-72459-000	N83-306032	6319G	77R1277
FLTAC2430535	Freightliner, Columbia, C112, C120 1996 - 2000	A22-42084-002	—	6229G	—
FLTAC2433650	Freightliner Cascadia 2008 - 2009	A22-62272	—	6345G	—



KENWORTH AND PETERBILT

PN	DESCRIPTION	KENWORTH AND PETERBILT X-REF	ALLIANCE X-REF	MEI X-REF	RED DOT X-REF
FLTAC2454028	Kenworth T-600 PF	K122-125	ABP N83 306575	6202G	77R6957
FLTAC2430286	Peterbilt 359, 377, 379, 385 Short Hood 1994 - 2000	18-04015	—	—	24-30286
FLTAC2450279	Kenworth T-2000 Radiator Mount 1990 - 2000	486684-5008	ABP N83 306620	6284G	RD-4-6560-0P
FLTAC2414679	Peterbilt Overall Dim 37 5/8", All 2005	1E5611	ABP N83 306930	6292G	—
FLTAC2433654	Kenworth T660 2008, Kenworth W900L 2007 - 2008	N4783001	—	6370G	—
FLTAC2433655	Kenworth T300 Block Fittings 2008 - 2009	M3659001	—	6358G	—



MACK AND VOLVO

PN	DESCRIPTION	MACK AND VOLVO X-REF	ALLIANCE X-REF	MEI X-REF	RED DOT X-REF
FLTAC2451200	Volvo VN Series 2000 - 2006 Conventional Cab with Sleeper	20461065	ABP N83 306022	6245AG	RD-4-6343-0P
FLTAC2450531	Mack CX Series 2000 - 2007	210RD59M	—	6251G	—
FLTAC2450529	Mack Granite 2003 - 2007	210RD428	—	6331G	RD-4-6415-0P
FLTAC2450526	Mack Granite Vision CX Series 2007 - 2010	210RD517M	—	6357G	—
FLTAC2433711	Mack LEU MRU613 2007 - 2015	210RD518M	—	—	—

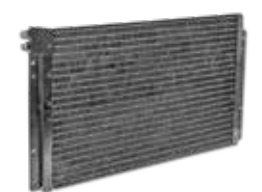

RECEIVER DRIERS AND ACCUMULATORS



INTERNATIONAL

PN	DESCRIPTION	FLEETRITE X-REF
2522825C1	Filter Dryer, Air Conditioner, HPV TXV	—
2522826C1	Filter Dryer, Air Conditioner	—
2522822C1	Filter Dryer, International ProStar® 2013 - 2016	FLTAC3719890



FREIGHTLINER

PN	DESCRIPTION	FREIGHTLINER X-REF	ALLIANCE X-REF	MEI X-REF	RED DOT X-REF
FLTAC3719896	A/C Dryer, Freightliner	088539-00	ABP N83 319744	7197G	74R-3120
FLTAC3719899	A/C Dryer	A22-63992-00	ABP N83 319755	7559G	74R4215
FLTAC3713994AM	Dryer, Freightliner Century, Coronado and Columbia 2000 - 2003	PH088446-00	—	7198G	74R3126
FLTAC3719895	Dryer, Freightliner Cascadia 2011 - 2016	A22-66700-000	—	7585G	—
FLTAC3719888	Dryer	A22-66600-000	—	7586G	—
FLTAC3719897	Dryer	A22-73395-000	—	—	—



RECEIVER DRIERS AND ACCUMULATORS (CONT'D)



KENWORTH AND PETERBILT

PN	DESCRIPTION	KENWORTH AND PETERBILT X-REF	ALLIANCE X-REF	MEI X-REF	RED DOT X-REF
FLTAC3713595AM	Dryer, Kenworth Kysor, Unit #936005 K251-521	088133-01	ABP N83 319190	7132G	74R2306
FLTAC3713539AM	Dryer, Kenworth 251-571 for X MIO	—	ABP N83 319028	7387G	74R3357
FLTAC3713995AM	Dryer, Kenworth T-2000 1996 - 2003; Peterbilt 387 1999 - 2003	F37-1000	—	7393G	74R2001
FLTAC3710935	Dryer	F37-6003	—	7398G	—
FLTAC3710934	Dryer	F37-6009	—	7399G	—
FLTAC3723539AM	Accumulator, Peterbilt 1995 - 2001	F31-6063	ABP N83 319069	—	74R5062



MACK AND VOLVO

PN	DESCRIPTION	MACK AND VOLVO XREF	MEI X-REF	RED DOT X-REF
FLTAC3713559AM	Dryer, Volvo, GM Truck, 3" x 9.18", 3/8" MIO HPRV MSP	088214-00	7159	74R3066
FLTAC3713572AM	Dryer, Mack 1993 - Current, OE# 221-RD-335	088294-01	7166G	—

BLOWER MOTORS



INTERNATIONAL

PN	DESCRIPTION	FLEETRITE X-REF	ALLIANCE X-REF	RED DOT X-REF
1669786C1	Blower Motor 1982 - 1983	FLTBM1669786	—	—
2611234C2	Actuator Heater Door	FLTAC3160102	—	RD-5-14607-0P
1699949C1	Blower Motor Assembly	FLTBM1699949	ABP N83 301065	—
1699291C1	Blower Motor IHC Flange	FLTBM1699291	ABP N83 301015	—
3542611C2	Blower Motor with Wheel	FLTBM3542611	—	—
3674285C1	Blower Motor with Wheel	FLTBM3674285	—	—
2602570C92	Blower Assembly Dual, 12V CCW	FLTBM2602570	—	—



FREIGHTLINER

PN	DESCRIPTION	FREIGHTLINER X-REF	ALLIANCE X-REF	MEI X-REF	RED DOT X-REF
FLTAC2613299	Blower Motor with Wheel, Freightliner, Front Unit CW	BOA85-440-50-009	ABP N83 301017	3924	73R3002
FLTAC2610010	Blower Assembly, Freightliner Century Class Front 2002 - 2006	BOAD8587	—	3967	73R3122
FLTAC2614033	Blower Motor Assembly with Wire Harness	VCC35000003	—	—	73R3152



PETERBILT AND KENWORTH

PN	DESCRIPTION	ALLIANCE X-REF	MEI X-REF	RED DOT X-REF
FLTAC2613351	Blower Motor, Peterbilt 320 Series 1988 - 2000	ABP N83 301072	3182	73R4182
FLTAC2613974	Blower Motor	ABP N83 301073	—	—
FLTAC2614583	Blower Motor, Peterbilt, Various Series, 12V 1995 - 1994	ABP N83 301461	—	—
FLTAC2613118	Blower Motor, HD, GMC, Brigadier, Mack, International	—	3389	—
FLTAC2801545	Wheel, Blower, Double, 3.4" x 4.5" Reversible	—	—	—
FLTAC2613475	Motor, Blower, Single Shaft, 1-Speed 5/16 Shaft CW	—	3972	—



MACK AND VOLVO

PN	DESCRIPTION	MACK AND VOLVO X-REF	MEI X-REF	RED DOT X-REF
FLTAC2613290	Blower Motor Assembly Double Shaft with Wheels	3946686	3251	73R5652
FLTAC2610010	Blower Assembly, Freightliner Century Class Front 2002 - 2006	D8587	3967	73R3122
FLTAC2619899	Blower Dual Assembly, Volvo, 12V	85120276	3916	—
FLTAC73R3102	Blower Motor with Wheel, Red Dot, 73R3102	7787-869445	—	73R3102



EXPANSION VALVES AND ORIFICE TUBES



INTERNATIONAL

PN	DESCRIPTION	FLEETRITE X-REF	MEI X-REF
2501794C93	Expansion Valve Kit	FLTAC3131010AM	1612
2513533C1	Valve, Orifice Tube, A/C	FLTAC3131234	1622
FLTEV3857948	Expansion Valve, A/C, No. 8 Hose Side Inlet, No. 10 Hose Side Outlet, No. 8 Evaporator Side Inlet	—	—
FLTEV2501794	Expansion Valve, A/C	—	—
FLTEV3857948	Expansion Valve, A/C, No. 8 Hose Side Inlet, No. 10 Hose Side Outlet, No. 8 Evaporator Side Inlet	—	—



FREIGHTLINER

PN	DESCRIPTION	APPLICATION	FREIGHTLINER X-REF	TRP X-REF	ALLIANCE X-REF	MEI X-REF	RED DOT X-REF
FLTAC3131047AM	Expansion Valve, A/C, Block Type, 3/8" Liquid Inlet, 1/2" Liquid Outlet, 5/8" Suction In, 3/4" Suction Out	—	BOA-A4965	—	ABPN83308107	1619	RD-5-12521-0P
FLTAC3131021AM	Expansion Valve, Block, Freightliner Century, Columbia 2002 – 2005	FLTAC3131021AM	BOA 93674	—	ABP N83 308117	1621	RD-5-12522-0P
FLTAC3131018AM	Expansion Valve, Block, Freightliner Century Main 2000 – 2002	—	BOA 80 321 00 269	EA14550	ABP N83 308231	1615	—



KENWORTH AND PETERBILT

PN	DESCRIPTION	KENWORTH AND PETERBILT X-REF	TRP X-REF	ALLIANCE X-REF	MEI X-REF	RED DOT X-REF
FLTAC3131026AM	Expansion Valve, Block, Kenworth 1997 – 2002; Peterbilt 1999 – 2001	540057	—	ABP N83 308141	1611	RD-5-8936-0P
FLTAC3131214	Expansion Valve, A/C, Block Type, 3/8" Liquid Inlet, 1/2" Liquid Outlet, 1/2" Suction In, 5/8" Suction Out	540446	—	—	1644	71R8460
FLTAC3131026AM	Expansion Valve, Block, Kenworth 1997 – 2002; Peterbilt 1999 – 2001	540057BSM	EA10050	A22-14423-0	1611	—
FLTAC3131009AM	Expansion Valve, Block, International, Class 8 (OE 540255)	540056BSM	—	—	1609G	—
FLTACMT00941	Orifice Tube, Ford Vehicles, Orange	5X010061	EC10150	ABP N83 308017	—	—
FLTAC3131335	Expansion Valve, A/C, Block	3S011516	—	—	1688	—



MACK AND VOLVO

PN	DESCRIPTION	MACK AND VOLVO X-REF	TRP X-REF	ALLIANCE X-REF	MEI X-REF	RED DOT X-REF
FLTAC3131257	Expansion Valve, A/C, Block	85104197	—	N83-308014	1672	71R8465
FLTAC3131261	Expansion Valve, A/C, Block	3543-T4935001	—	—	1678	—
FLTAC3131377	Expansion Valve, A/C, Block	85120289	EA14150	—	1684G	—



Fleetrite® HVAC Systems – Quality Welds

Fleetrite HVAC systems are manufactured with quality welds to minimize vibration issues, with replacement precision fit.

fleetrite.com

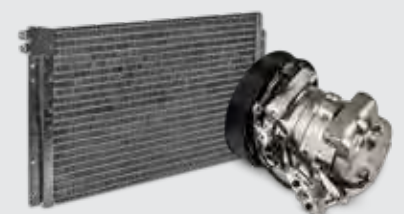

Fleetrite® Program – Over 5,000 Parts

Did you know? The Fleetrite program consists of over 5,000 part numbers for all your HVAC product needs.

fleetrite.com



SWITCHES AND RESISTORS



INTERNATIONAL

PN	DESCRIPTION	FLEETRITE X-REF	ALLIANCE X-REF	MEI X-REF	RED DOT X-REF
2606229C92	Sensor Refrigerant Temperature	FLTACMT1323	—	—	71R6265
3546241C1	Pressure Transducer	FLTACMT3512	ABP N83 323100	1473	71R6260
3521729C1	High Pressure Switch	FLTAC2930742	—	—	—



FREIGHTLINER

PN	DESCRIPTION	FREIGHTLINER X-REF	ALLIANCE X-REF	RED DOT X-REF
FLTACMT1907	High Pressure Cut-Off Switch	A22-45194-001	ABP N83 318180	71R6210
FLTACMT1366	Binary Pressure Switch	A22-43249-000	ABP N83 318179	71R7077
FLTACMT1634	Binary Pressure Switch	22-51296-000	ABP N83 318209	71R6150



KENWORTH AND PETERBILT

PN	DESCRIPTION	KENWORTH/PETERBILT X-REF	ALLIANCE X-REF	RED DOT X-REF
FLTACMT1638	High Pressure Cut-Off Switch	18-03836	ABP N83 318160	71R6160
FLTACMT1639	Low Pressure Cut-Off Switch, M12-1.5, Female O-Ring	18-03834	ABP N83 318184	71R6170
FLTACMT1635	High Pressure Cut-Off Switch	18-03835	ABP N83 318170	71R6180
FLTACMT1914	Binary Pressure Switch	79PSD41	—	—
FLTACMT1925	Low Pressure Switch	B6525788BSM	—	—



MACK AND VOLVO

PN	DESCRIPTION	MACK/VOLVO X-REF	ALLIANCE X-REF	MEI X-REF
FLTACMT1363	Blower Motor Resistor	BSM321000	ABP N83 321000	1233

REFRIGERANTS AND RELAYS



REFRIGERANTS (U.S.)

PN	DESCRIPTION	APPLICATION
WEIR134A	30 Lbs. Cylinder	All R134A Applications
WEIR134ACANS	12 Oz. Cans	All R134A Applications
WEIR404	24 Lbs. Cylinder	All R404A Applications
WEIR1234YF	10 Lbs. Cylinder	All R1234YF Applications
WEIR1234YFCANS	8 Oz. Refrigerant Cans	All R1234YF Applications



REFRIGERANTS (CAN)

PN	DESCRIPTION	APPLICATION
R404	24 Lbs. Cylinder	All R404A Applications

RELAYS

PN	DESCRIPTION	ALLIANCE X-REF	MEI X-REF
FLTACMT0320	5-Pin Universal Single Pole Double Throw RE	—	—
FLTAC3013412	Relay P and B 2622, Single Pole Double Throw HD, 40-30 Amp, 12V	ABP N83 320020	—
FLTACMT0967	Compressor Control Radiator Fan Relay	—	1292



AUXILIARY HEATING AND COOLING

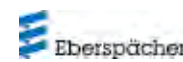

WEBASTO

PN	DESCRIPTION	WEBASTO X-REF
WEB5013920A	Thermo Top, EVO, 12V, Diesel Engine, P-Heat, SmarTemp 3.0 Bluetooth Kit	5013920A
WEB5013916A	TP90, 12V, Diesel EB, SmarTemp 3.0 Bluetooth Kit	5013916A
WEB5013914A	Tandem, Thermo Top, EVO-AT000STC, SmarTemp 3.0 Bluetooth Kit	5013914A
WEB5013913A	AT2000STC, 12V, Diesel, SmarTemp 3.0 Bluetooth Sleeper Kit	5013913A



PHILLIPS AND TEMRO

PN	DESCRIPTION	APPLICATION	PHILLIPS AND TEMRO X-REF
ZBL3400122	Pad Heater Electric, CSA, 5.0" x 7", 500W, 120V	Adhesive for Oil Pan, Transmission or Hydraulic Fluids	3400122
ZBL3400065	Pad Heater Electric, 6.0" x 10.75", 1000W, 120V	Adhesive for Oil Pan, Transmission or Hydraulic Fluids	3400065
ZBL3400124	Filter Wrap Pad Heater FH, 4.0" x 9.0", 100W, 120V	Fuel/Oil Filter Wrap	3400124
ZBL2800071	Thin BB CSA, 72" Length, 160W	Battery Wrap Group 31 or Series Parallel Systems	2800071
ZBL3400102	Silicon Pad Heater BH, 13.0" x 20.5", 180W, 120V	Battery Warming for Group 31	3400102
ZBL3500163	Kit 9 Heater and Cordset, 1250W, 120V	Coolant Heater MaxxForce® DT 2007 – Current	3500163
ZBL3500044	CSA, 1250W, 120V	DT466, DT570 2004 – 2006; DT408, DT466, DT466E, 530, 570 1994 – 2000	3500044
ZBL3500107	Cummins ISX CSA, 1500W, 120V	ISX, ISX12, ISX12G, QSX 2007 – Current	3500107
ZBL8605688	WP FLD KT with 4-Hole Flange, 120V	Weatherproof Receptacle and Plug Kit	8605688
ZBL8600015	10L CSA, 1500W, 120V	Cummins L10 611 CID 6 Cylinder, M11, ISM Series, QSM 11	8600015
ZBL3500111	#14 Stor CSA Kit, 1500W, 120V	MaxxForce® 15	3500111
ZBL3600087	Thermostat Assembly 40–55 Degrees	International, Detroit Diesel®, Cummins ISX	3600087
ZBL3600054	72", WP Indicator Light Kit with Thermostat, 120V	Weatherproof Wire Harness with Thermostat	3600054
ZBL3600008	16/3 HPN 72" Strait Cord, 120V, 15A	Wire Harness with Right Angle Connector	3600008
ZBL8500633	Cab Power Basic Kit	Regular Cab Power Kit with Wire Outlet and Load Center	8500633
ZBLSHFT25122426	Hot Fox™ with Thermostat 24–26 Tank	Arctic Fox® and Hot Fox™ Fuel Warm	SHFT-2512-24-26
ZBLSHFT25121717	Hot Fox™ with Thermostat 17–19 Tank	Arctic Fox® and Hot Fox™ Fuel Warm	SHFT-2512-17-17
ZBLI909BTB100	1/2" NPT with 15.5" Length, 304 Stainless Thermostatically Controlled	Arctic Fox® In-Line Fuel Heater Diesel and Up to B100 Bio Diesel	I909BT-B100



ESPAR

PN	DESCRIPTION	APPLICATION	ESPAR X-REF
ESP2028272102010Z	Airtronic S2 Commercial 12V Heater	Truck, Off-Highway, Cargo	25.2726.05.0000.0Z
ESP25272605000000Z	Hydronic S3 Economy CS 12V Heater	Truck, Off-Highway, Cargo	25.2934.05.0000.0Z
ESP2528293405010Z	Install Kit Airtronic S2 12V with EPRO and PU	Truck, Off-Highway, Cargo	20.2827.21.0201.0Z
ESP25252605000000Z	Install Kit Hydronic S3 CS 12V Heater	Truck, Off-Highway, Cargo	25.2526.05.0000.0Z



Maintenance Time

Air in the fuel line of your Webasto heater can be a challenge and sometimes hard to detect. This simple tech tip will help you quickly identify if you have air in your fuel lines and how to remedy that issue.

STEPS

First take the fuel line off the heater and submerge it in a container with a liquid. Fuel is preferable, but even water would work fine for this.



Next cycle the fuel pump and watch the submerged end of the fuel line for bubbles. If bubbles are present, proceed to the next steps.



The fuel clamps must be tightened until the 'tabs' or 'ears' on the clamp are touching. Inspect the fuel lines, filter, and couplings for cracks or other damage, as well as the fuel clamps for proper torque.



Repair the issue and retest.

webasto.com

VENTILATION



INTERNATIONAL

PN	DESCRIPTION	FLEETRITE X-REF	MEI X-REF	RED DOT X-REF
2506656C1	Cabin Air Filter, International 4200 - 8600 Series 2003 - 2005	FLTAC9801101	—	78R5435
481813C1	Cabin Air Filter, 9" x 10 1/2" x 3/4"	FLTAC9810016	7989	—
1696834C1	A/C Filter, Evaporator, International	FLTAC9801159	—	—
3839141C1	Cabin Air Filter, International	FLTAC9801152	—	—
3839326C1	Cabin Air Filter	FLTAC9801150	—	—



FREIGHTLINER

PN	DESCRIPTION	FREIGHTLINER X-REF	ALLIANCE X-REF
FLTAC9801100	Cabin Air Filter, Freightliner Coronado and Columbia 2002 - 2005	BOA91559	ABP N83 328385
FLTAC9801157	Cabin Air Filter, Freightliner	VCC36000006	—

MACK AND VOLVO

PN	DESCRIPTION	MACK AND VOLVO X-REF	MEI X-REF	RED DOT X-REF
FLTAC9801156	Filter, Mack, 7787-525784	7787-525784	—	—
FLTAC9800001	Filter, Mack and Volvo	85112361	7956M	—
FLTAC9801107	Cabin Air Filter, Volvo VN Series 2003 - 2005	20435801	—	78R5242

KENWORTH AND PETERBILT

PN	DESCRIPTION
FLTAC9801153	Duct Filter, Kenworth, 534510



Maintenance Time

Webasto strives to offer the best heating solution for your application. One aspect that contributes to a great heating solution is a low-maintenance schedule. We'll outline the monthly and annual maintenance required for our most popular evaporative heaters. But first, we'll make a list of both the evaporative and high-pressure nozzle heaters.

EVAPORATIVE BURNER HEATERS

- Air Top 2000STC
- Air Top EVO 40 and 55 models
- Thermo Pro 50 ECO
- Thermo Pro 90
- Thermo Top C
- Thermo Top EVO

HIGH-PRESSURE NOZZLE HEATERS

- Thermo Top Pro 150
- Thermo E+ 320

HEATER MODEL MONTHLY MAINTENANCE ANNUAL MAINTENANCE



Air Top 2000STC

Operate the heater for 10 minutes at full load.

Perform the following checks before each heating season:

Checking heating air inlet and outlet for dirt and foreign objects. (Dirty or blocked heating air lines can cause overheating.)

Clean heater exterior (make sure no water gets in).

Check electrical connections for contact-corrosion and to ensure they are secure.

Check exhaust and combustion air intake lines for damage and ensure they are clear.

Replacing fuel filter, if fitted.

Checking fuel line and filter for leaks.



Thermo Top EVO

Operate the heater for 10 minutes at full load.

Perform the following checks before each heating season:

Clean heater exterior (make sure no water gets in).

Check electrical connections for contact-corrosion and to ensure they are secure.

Check exhaust and combustion air intake lines for damage and ensure they are clear.

Replacing fuel filter, if fitted.

Checking fuel line and filter for leaks.

Check coolant hose connections.

Check coolant hoses for cracks, swelling, or any other damage. Replace as necessary.

Check coolant hose clamps.

Check freeze protection point of coolant.

webasto.com

IT'S NOT JUST A CARD.



FLEET CHARGE® KEEPS YOUR BUSINESS UP AND RUNNING AND YOU IN CONTROL OF YOUR COSTS.



IT'S PROFIT IN YOUR POCKET AND A WHOLE LOT MORE.

- Get guaranteed pricing on proprietary and all-makes parts sourced by International® Truck.
- Enjoy instant customer recognition and a line of credit at 650+ International Truck and IC Bus dealerships.
- No enrollment fees, finance charges or hidden costs.



IT'S EASE, SPEED AND UPTIME.

- Get powerful online account management tools and consolidated billing.
- Eliminate wait times for mailed statements and invoice copies.
- Track unpaid and unbilled invoices, and receive daily invoice updates.

APPLY NOW AT WWW.FLEETCHARGE.COM





LIGHT UP THE BENEFITS.

Low power consumption, reducing load on truck systems.

Order online at RepairLinkShop.com

PARTS FIT TO PERFORM

fleetrite.com



LOOK ON THE BRIGHT SIDE.

LED has been established as the lighting technology of choice for the commercial vehicle industry

BUILT FOR A LIFETIME

optronicsinc.com



HEADLAMPS



HEADLAMPS						
PN	DESCRIPTION	APPLICATION	OPTRONICS X-REF	GROTE X-REF	GE/TUNGSRAM X-REF	TRUCK-LITE X-REF
FLTH6054	H6054 Rectangular Sealed Beam, 12V 65W/35W	5" x 7" Exterior Headlamp	—	—	H6054	—
FLTH6024	H6024 Round Sealed Beam, 12V 65W/35W	7" Exterior Headlamp	—	—	H6024	—
FLTH5024	H5024 Round Sealed Beam, 12V 65W/42W, Long Life	7" Exterior Headlamp	—	—	H5024	—
FLTH4656	H4656 Rectangular Sealed Beam, Low, 12V 35W	4" x 6" Exterior Headlamp	—	—	H4656	—
TLD27455C	Heated Lens Universal LED, 12-24V	5" x 7" Heated Headlamp	—	—	—	27455C
TLD37270C	LED Projector, Round, Clear, 6 Diodes	7" Round Headlamp	—	—	—	37270C
TLD37450C	LED Projector, Rectangular, Clear, 6 Diodes	5" x 7" Headlamp	—	—	—	37450C
TLD37640C	LED Projector, Rectangular, Clear, 2 Diodes	4" x 6" Low Beam Headlamp	—	—	—	37640C
TLD37645C	LED Projector, Rectangular, Clear, 4 Diodes	4" x 6" High Beam Headlamp	—	—	—	37645C
TLD37650C	LED Projector, Rectangular, Clear, 2 Diodes	4" x 6" Low Beam Heated Headlamp	—	—	—	37650C
TLD37655C	LED Projector, Rectangular, Clear, 4 Diodes	4" x 6" High Beam Heated Headlamp	—	—	—	37655C
OPHLL78LB	LED, Low Beam, 11 Diodes	4" x 6" Truck Head Lamp	HLL78LB	—	—	—
OPHLL79HB	LED High Beam, 11 Diodes	4" x 6" Truck Head Lamp	HLL79HB	—	—	—
OPHLL93HLB	LED High/Low Beam, Round, 11 Diodes, Plug	7" Truck Head Lamp	HLL93HLB	—	—	—
ZBJ64M115	LED Radius Light	Trailer/Truck, Side/Rear Door	—	ZBJ64M115	—	—
ZBJ64M215	LED Fairing Light	Truck Fairings	—	ZBJ64M215	—	—
ZBJD64W41	Trilliant® Oval LED Long Range, 2000 Lumens, Flood Pattern	Side/Rear Door Lumination	—	ZBJD64W41	—	—
ZBJDBZ5015	BriteZone™ LED 1100 Lumens, Go Anywhere Handheld	Handheld Work Lamp	—	ZBJDBZ5015	—	—
ZBJDBZ1315	BriteZone™ LED 4000 Lumens, Round with Switch	Maintenance Vehicles	—	ZBJDBZ1315	—	—
ZBJDBZ3315	BriteZone™ LED 860 Lumens, Small Rectangle	Side/Rear Door Lumination	—	ZBJDBZ3315	—	—



STOP/TURN/TAIL, SIDE, MARKER/CLEARANCE



STOP/TURN/TAIL AND FRONT/PARK/TURN LIGHTS – INCANDESCENT						
PN	DESCRIPTION	APPLICATION	OPTRONICS X-REF	GROTE X-REF	GE/TUNGSRAM X-REF	TRUCK-LITE X-REF
FLT1157	1157 Bulb 12V	Exterior Stop/Turn Signal	—	—	1157	—
FLT1156	1156 Bulb 12V	Exterior Stop	—	—	1156	—
FLT3156	3156 Bulb, Plastic Wedge Base, 12V	Exterior Stop	—	—	3156	—
FLT3157NA	3157NA Bulb, Amber, Plastic Wedge Base, 12V	Exterior Stop/Turn Signal	—	—	3157NA	—
FLT1157NA	1157NA Bulb, Amber, Plastic Wedge Base, 12V	Exterior Stop/Turn Signal	—	—	1157NA	—
FLT3457NA	3457NA Bulb Amber, 12V	Exterior Stop/Turn Signal	—	—	3457NA	—
TL60215Y	60 Series, Horizontal Mount, Yellow Oval, 1 Bulb, PL-3, 12V	Side Mounted Turn Signal Lamp	—	52193	—	60215Y
TL40202R	40 Series, Red, Round, 1 Bulb, PL-3, 12V	Rear Mounted Stop/Turn/Tail Lamp	—	52772-5	—	40202R
TL60202R	Super 60, Red, Oval, 1 Bulb, PL-3, 12V	Rear Mounted Stop/Turn/Tail Lamp	—	52892	—	60202R
TL40242R	Super 40, Red, Round, 1 Bulb, PL-3, 12V	Rear Mounted Stop/Turn/Tail Lamp	—	52592	—	40242R
OPTST45RBP	Sealed, Red	4" Truck/Trailer Tail Light	ST45RBP	52692	—	40042R
OPTST70RBP	Oval Sealed, Red	Truck/Trailer Tail Light	ST70RBP	52892	—	60024R



STOP/TURN/TAIL, SIDE, MARKER/CLEARANCE (CONT'D)



STOP/TURN/TAIL AND FRONT/PARK/TURN LIGHTS - LED

PN	DESCRIPTION	APPLICATION	OPTRONICS X-REF	GROTE X-REF	TRUCK-LITE X-REF
FLTCM34001R	Round with Bullet Terminals, 1 LED	3/4" Truck/Trailer Marker/Clearance	MCL11RHYPG	49322	33050R
FLTCM34001A	Round with Bullet Terminals, 1 LED	3/4" Truck/Trailer Marker/Clearance	MCL11AHYPG	49323	33050Y
FLTCM21002R	Mini Oval with Bullet Terminals, 2 LED	Truck/Trailer Marker/Clearance	—	47962	—
FLTCM21002A	Mini Oval with Bullet Terminals, 2 LED	Truck/Trailer Marker/Clearance	—	47963	—
FLTCM20003R	Round, 3 LED	2" Truck/Trailer Marker/Clearance	MCL55RBP	MKR4500RPG	30050R
FLTCM20003A	Round, 3 LED	2" Truck/Trailer Marker/Clearance	MCL55ABP	MKR4500YPG	30050Y
FLTCM25003R	Round, 3 LED	2.5" Truck/Trailer Marker/Clearance	MCL57RBP	MKR4600RPG	10256R
FLTCM25003A	Round, 3 LED	2.5" Truck/Trailer Marker/Clearance	MCL57ABP	MKR4600YPG	10256Y
FLTSTT40007R	Red Round, 7 LED	4" Truck/Trailer Stop/Turn/Tail	STL13RBP	—	44030R
FLTPT40007A	Amber Round, 7 LED	4" Truck/Trailer Park/Turn	STL13ABP	—	44094Y
FLTSTT40012R	Red Round, 12 LED	4" Truck/Trailer Stop/Turn/Tail	STL23RBP	53252	4058
FLTPT40012A	Amber Round, 12 LED	4" Truck/Trailer Stop/Turn/Tail	STL23ABP	53253	4058A
FLTSTT60010R	Red Oval, 10 LED	6" Truck/Trailer Stop/Turn/Tail	STL72RBP	54132	6058
FLTPT60010A	Amber Oval, 10 LED	6" Truck/Trailer Park/Turn	STL72ABP	54133	6058A
FLTSTTBU40014RW	Round Combination with Backup Light	4" Truck/Trailer Stop/Turn/Tail	STL201XRBP	55162	44556R
FLTSTTBU60014RW	Oval Combination with Backup Light	6" Truck/Trailer Stop/Turn/Tail	STL68RBP	54682	60559R
TL44326R	Super 44, Red, Round, Black, Flange Mounted, Fit 'N Forget Stainless Steel, 12V, LED, 6 Diodes	Rear Mounted Stop/Turn/Tail Lamp	—	54022	44326R
TL44322R	Super 44, Red, Round, Grey, Flange Mounted, Fit 'N Forget Stainless Steel, 12V, LED, 6 Diodes	Rear Mounted Stop/Turn/Tail Lamp	—	53292	44322R
TL6050	Signal-Stat, Red, Oval, PL-3, 12V, LED, 24 Diodes	Rear Mounted Stop/Turn/Tail Lamp	—	18FR1019	6050
TL44030R	Super 44, Red Round, Black, Grommet Mounted, Fit 'N Forget Stainless Steel, Straight PL-3 Female, 12V, Kit, LED, 6 Diodes	Rear Mounted Stop/Turn/Tail Lamp	—	—	44030R
TL60256R	60 Series, Red, Oval, Black, Flange Mounted, Fit 'N Forget Stainless Steel, 12V, LED, 26 Diodes	Rear Mounted Stop/Turn/Tail Lamp	—	53622	60256R
OPTSTL13RBP	Round, Red, 7 LED	Truck/Trailer Tail Light	STL13RBP	53252	44022R
OPTSTL13RMBP	Round, 7 LED	Truck/Trailer Tail Light	STL13RMBP	—	44022R
OPTSTL43RBP	Round, Red, 10 LED	Truck/Trailer Tail Light,	STL43RBP	53252	44202R
OPTSTL12RBP	Recessed, Red, LED, 6 Diodes	6" Truck/Trailer Tail Light	STL12RBP	53962	66250R
OPTSTL101RBP	GloIt, Round, PL3, LED	Truck/Trailer Tail Light	STL101RBP	—	—
OPTSTL111RBP	GloIt, Oval, PL3, LED	Truck/Trailer Tail Light	STL111RBP	—	—
OPTSTL72RBP	Grommet Mount, LED, 10 Diodes	6" Truck/Trailer Tail Light	STL72RBP	53962	6050
ZBJD54302	Nexgen, Male Pin, LED	4" Stop/Turn/Tail Lamp	—	ZBJD54302	—
ZBJD54672	Oval with Integrated Backup Lamp, LED	6" Stop/Turn/Tail Lamp	—	ZBJD54672	—
ZBJD54132	Oval Supernova, Male Pin, LED	6" Stop/Turn/Tail Lamp	—	ZBJD54132	—



MARKER/CLEARANCE AND LICENSE

PN	DESCRIPTION	APPLICATION	OPTRONICS X-REF	GROTE X-REF	GE/TUNGSRAM X-REF	TRUCK-LITE X-REF
FLTCM26006R	Red Reflex, 6 LED	2" x 6" Marker/Clearance	MCL76RBP	G2102	—	2150
FLTCM26006A	Amber Reflex, 6 LED	2" x 6" Marker/Clearance	MCL76ABP	G2103	—	2150A
FLTCMN62011A	International Oval Amber, 11 LED	International, Side Turn Marker	—	—	—	—
FLTCMN62011AC	International Oval Amber/Clear, 11 LED	International, Side Turn Marker	—	—	—	—
FLTCMF53005A	Freightliner Cascadia Oval Amber, 5 LED	Freightliner, Side Turn Marker	—	—	—	—
FLTCMF37014A	Freightliner M2 Oval Amber, 14 LED	Freightliner, Side Turn Marker	—	—	—	—
FLTCMID25024R	Stainless Steel 3 Light ID Bar with Red, 24 LED	2.5" Marker/Clearance	MCL84RBP	49182	—	15050R
FLTCMID34003R	Stainless Steel 3 Light ID Bar with Red Round, 3 LED	3/4" Marker/Clearance	MCL922RBP	—	—	33740R



STLW316 SERIES

STLW316MGHB (grommet mount)
STLW316MSHB (flange mount)

20-LED 6" Stop/Turn/Tail/Back-Up Light with built-in Warning Lamps. Stop/turn functions override the warning lamp for constant DOT compliance. Four flash patterns connect multiple lights to synchronize flash! Designed for under/over 80" applications. Lifetime LED Warranty.

www.optronicsinc.com

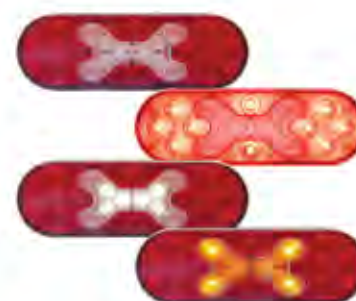

STOP/TURN/TAIL, SIDE, MARKER/CLEARANCE (CONT'D)



MARKER/CLEARANCE AND LICENSE (CONT'D)

PN	DESCRIPTION	APPLICATION	OPTRONICS X-REF	GROTE X-REF	GE/TUNGSRAM X-REF	TRUCK-LITE X-REF
FLTLC26006W	License Plate with Chromed ABS Housing, 6 LED	2.6" License	15040	60001	—	10202R
FLTLC26106W	License Plate with Black ABS Housing, 6 LED	2.6" License	15041	60011	—	10202Y
FLT194	194 Bulb, Indicator, Courtesy 12V	Interior/Exterior Miniature Marker	—	—	194	—
FLT194NA	194 Amber	Exterior Miniature Side Marker	—	—	194NA	—
TL10202R	10 Series, Red Round, 1 Bulb, PC, PL-10, 12V	Marker/Clearance Lamp, Incandescent	—	45812	—	10205R
TL10202Y	10 Series, Yellow Round, 1 Bulb, PC, PL-10, 12V	Marker/Clearance Lamp, Incandescent	—	45813	—	10205Y
TL10205R	10 Series, Red Round, 1 Bulb, PC, PL-10, 12V	Marker/Clearance Reflectorized Lamp, Incandescent	—	45832	—	10250R
TL10205Y	10 Series, Yellow Round, 1 Bulb, PC, PL-10, 12V	Marker/Clearance Reflectorized Lamp, Incandescent	—	45833	—	10250Y
TL10250R	10 Series, Red Round, P2, Fit 'N Forget, 12V, 2 Diodes	Marker/Clearance Lamp, LED	—	47122	—	15011
TL10250Y	10 Series, Yellow Round, P2, Fit 'N Forget, 12V, 2 Diodes,	Marker/Clearance Lamp, LED	—	43160	—	15205
TL15011	15 Series, 1 Bulb, Rectangular, Grey Bracket Mount, PL-10, 12V, Kit	License Plate Lamp, Incandescent	—	18H13	—	15208
TL15205	15 Series, Rectangular, Bracket Mount, Hardwired, Female PL-10, 12V, 3 Diodes	License Plate Lamp, LED	—	18H242	—	19200R
TL15208	15 Series, 1 Bulb, Rectangular, Bracket Mount, PL-10, 12V	License Plate Lamp, Incandescent	—	18H184	—	19206
TL19200R	19 Series, Base Mount, Red Rectangular, 2 Bulbs, PC, 19 Series Male Pin, 12V	Marker/Clearance Lamp, Incandescent	—	46742	—	21002R
TL19206	19 Series, 2 Bulbs, Rectangular, Bracket Mount, 19 Series Male, 12V	License Plate Lamp, Incandescent	—	E1738	—	21002Y
TL21002R	Super 21, Red Rectangular, 1 Bulb, P2, 2 Screw, Super 21 Plug, Stripped End, 12V, Kit	Marker/Clearance Lamp Reflectorized, Incandescent	—	46072	—	21051Y
TL21002Y	Super 21, Yellow Rectangular, 1 Bulb, P2, 2 Screw, Super 21 Plug, Stripped End, 12V, Kit	Marker/Clearance Lamp, Reflectorized, Incandescent	—	46073	—	21251R
TL21051Y	21 Series, Yellow Rectangular, PC, 2 Screw, Fit 'N Forget, .180 Bullet Terminal/Ring Terminal, 12V, Kit, 2 Diodes,	Marker/Clearance Reflectorized Lamp, LED	—	47073	—	21251Y
TL21251R	21 Series, Red Rectangular, PC, 2 Screw, Fit 'N Forget, 12V, 1 Diode	Marker/Clearance Reflectorized Lamp, LED	—	47072	—	30200R
TL21251Y	21 Series, Yellow Rectangular, PC, 2 Screw, Fit 'N Forget, 12V, 2 Diodes	Marker/Clearance Reflectorized Lamp, LED	—	—	—	30200Y
TL30200R	30 Series, Red Round, 1 Bulb, PC, PL-10, 12V	Marker/Clearance Lamp, Incandescent	—	45822	—	33250R
TL30200Y	30 Series, Yellow Round, 1 Bulb, PC, PL-10, 12V	Marker/Clearance Lamp, Incandescent	—	45823	—	33250Y
TL33250R	33 Series, Red Round, P2, Hardwired, .180 Bullet Terminal, 12V, 1 Diode,	Marker/Clearance Lamp, LED	—	49202	—	35001R
TL33250Y	33 Series, Yellow Round, P2, Hardwired, .180 Bullet Terminal, 12V, 1 Diode	Marker/Clearance Lamp, LED	—	49203	—	35001Y
TL35001R	35 Series, Red Rectangular, P2, 2 Screw, Fit 'N Forget M/C, .180 Bullet Terminal/Ring Terminal, 12V, Kit, 1 Diode,	Marker/Clearance Lamp, LED	—	—	—	35200R
TL35001Y	35 Series, Yellow Rectangular, P2, 2 Screw, Fit 'N Forget .180 Bullet Terminal/Ring Terminal, 12V, Kit, 2 Diodes	Marker/Clearance Lamp, LED	—	—	—	35200Y
TL35200R	35 Series, Red Rectangular, P2, 2 Screw, Fit 'N Forget, 12V, 1 Diode,	Marker/Clearance Lamp, LED	—	47242	—	35200R
TL35200Y	35 Series, Yellow Rectangular, P2, 2 Screw, Fit 'N Forget, 12V, 2 Diodes	Marker/Clearance Lamp, LED	—	47243	—	35200Y
OPTMCL55ABP	Marker Light, Amber	2" LED Truck/Trailer	MCL55ABP	47113	—	30050Y
OPTMCL55RBP	Marker Light, Red	2" LED Truck/Trailer	MCL55RBP	47112	—	30050R
OPTMCL56ABP	Amber, 1 Diode	2" Marker/Clearance Lamp, LED	MCL56ABP	—	—	30070Y
OPTMCL56RBP	Red, 1 Diode	2" Marker/Clearance Lamp, LED	MCL56RBP	—	—	30070R
OPTMCL527ABP	Amber, 2 Diodes	2.5" Marker/Clearance Lamp, LED	MCL527ABP	47123	—	—
OPTMCL527RBP	Red, 2 Diodes	2.5" Marker/Clearance Lamp, LED	MCL527RBP	47122	—	—
OPTMCL57ABP	LED Marker Light, Amber	2.5" Marker Lamp, LED	MCL57ABP	—	—	10050Y
OPTMCL57RBP	LED Marker Light, Red	2.5" Marker Lamp, LED	MCL57RBP	—	—	10050R
OPTMCL10AKBP	LED Nondirectional Unit, Grommet, Amber	Truck/Trailer	MCL10AKBP	49333	—	—
OPTMCL10RKBP	LED Nondirectional Unit, Grommet, Red	Truck/Trailer	MCL10RKBP	—	—	—
OPTPL26SKBP	License Bracket, Grey Housing, LED, Kit	Truck/Trailer	LPL26SKBP	60681	—	15040
OPTPL31CBP	LED License Light, Miniature	Truck/Trailer	LPL31CBP	G6151	—	434WD



STOP/TURN/TAIL, SIDE, MARKER/CLEARANCE (CONT'D)



GROMMETS, PIGTAILS, ETC.

PN	DESCRIPTION	APPLICATION	OPTRONICS X-REF	GROTE X-REF	TRUCK-LITE X-REF
FLTCN3000	3-Pin Right Angle Connector	Truck/Trailer Stop/Turn/Tail	A47PBP	67090	94993
FLTCN3001	3-Pin Straight In-Line Connector	Truck/Trailer Stop/Turn/Tail	A45PBP	67000	94926
FLTCN2000	2-Pin In-Line Connector	Truck/Trailer	—	—	94919
FLTCN2001	2-Pin Right Angle Connector	Truck/Trailer	A46PB	67050	94924
FLTCN3201AMP	3-Pin Weather Pack Amp Connector, Trucklite Style to PL-3 Female	Truck/Trailer Stop/Turn/Tail	—	—	—
FLTCN3211AMP	3-Pin Weather Pack AMP Connector, Trucklite Style to Bare Wire	Truck/Trailer	—	—	—
FLTCN3212AMP	3-Pin PL-3 Connector to Weather Pack Amp Connector, Trucklite Style	Truck/Trailer Stop/Turn/Tail	—	—	—
FLTGM4000	4" Grommet	Truck/Trailer	A45GBP	91740	40403
FLTGM6000	6" Grommet	Truck/Trailer	A70GBP	92420	60403
FLTGM2000	2" Grommet	Truck/Trailer	A54GBP	92120	30401
FLTGM2501	3" Grommet	Truck/Trailer	—	91410	—
TL94993	Plug, 16 Gauge GPT Wire, Right Angle PL-3, Stripped End/Ring Terminal, 11"	7" Stop/Turn/Tail Pigtail, PL-3 Connector with Ring Terminal	—	18P1456	94993
TL94902	Plug, 16 Gauge GPT Wire, PL-10, Stripped End/Ring Terminal	7" Marker/Clearance Pigtail, PL-10 Connector with Ring Terminal	—	18P1409	94902
TL40700	Open Back, Black PVC, Grommet for 40 Series, 44 Series, Round	4" Round Lamp Grommet	—	10209678	40700
TL94706	Plug, 16 Gauge GPT Wire, Female PL-3, Fit 'N Forget Stainless Steel	8" Stop/Turn/Tail Pigtail, PL-3 Connector	—	18P1352	94706
TL94707	Plug, 16 Gauge GPT Wire, Fit 'N Forget, Stainless Steel	8" Stop/Turn/Tail Pigtail, Stripped End/Ring Terminal	—	15-62545	94707
TL60700	Open Back, Black PVC, Grommet for 60 Series, Oval	2" x 6" Oval Lamp Grommet	—	18A163	60700
TL10700	Open Back, Wide Groove, Black PVC, Grommet for 10 Series, Round	2.5" Lamp Grommet	—	CS650029	10700
TL94862	Plug, 16 Gauge GPT Wire, Fit 'N Forget, .180 Bullet Terminal, Ring Terminal	5" Marker/Clearance Pigtail, Bullet Terminal, Ring Terminal	—	18P1713	94862
TL30700	Open Back, Black PVC, Grommet for 30 Series, Round	2" Lamp Grommet	—	T30698	30700
TL33700	Open Back, Black Rubber, Grommet for 33 Series, Round	0.75" Lamp Grommet	—	33700	33700
TL93745	Plug, 16 Gauge GPT Wire, Fit 'N Forget, Female PL-10	4" Marker/Clearance Pigtail, PL-10	—	A2693C	93745
TL95001	Plug, 16 Gauge GPT Wire, Fit 'N Forget, Stainless Steel	8" Stop/Turn/Tail Pigtail, Male Pin	—	18P2461	95001
TL94926	Plug, 16 Gauge GPT Wire, Straight PL-3	11" Stop/Turn/Tail Pigtail PL-3 Connector with Stripped End/Ring Terminal	—	18FR993	94926
TL94924	Plug, 16 Gauge GPT Wire, PL-10 Right Angle, Stripped End/Ring Terminal	6.5" Marker/Clearance Pigtail, PL-10 Connector with Ring Terminal	—	67050-5	94924
OPTA45GBP	4" Round Grommet	Truck/Trailer	A45GBP	91740	40403
OPTA45PBP	Pigtail Straight, Tail Lights	Truck/Trailer	A45PBP	67000	94926
OPTA45PMBP	Pigtail Straight, Weathertight	Truck/Trailer	A45PMBP	—	94926
OPTA46PBP	Pigtail, 2 Wire Straight, 6" Lead	Truck/Trailer	A46PBP	67050	94924
OPTA54GBP	Grommet Ring, 2" Flush	Truck/Trailer	A54GBP	—	30700
OPTA55GBP	Grommet Ring, 2.5" Flush	Truck/Trailer	A55GBP	—	30700
OPTA70GBP	6" Oval Grommet	Truck/Trailer	A70GBP	67151	60700
ZBJD66815	3-Wire Plug	6" Male Pin, Stop/Turn/Tail Pigtail	—	ZBJD66815	—
ZBJD66825	3-Wire Plug	8" Female Pin, Stop/Turn/Tail Pigtail	—	ZBJD66825	—
ZBJD66851	Double Seal, Ground Return, Bullet	6" Sealed Marker Light Pigtail	—	ZBJD66851	—
ZBJ67001	Double Seal, Ring Terminal Ground, Blunt Cut Wire	6" Sealed Marker Light Pigtail	—	ZBJ67001	—



WORK LIGHTING



WORK LIGHTING						
PN	DESCRIPTION	APPLICATION	OPTRONICS X-REF	GROTE X-REF	GE/TUNGSRAM X-REF	TRUCK-LITE X-REF
FLTWL36009FL	High Output, 1600 Lumen, 9 LED	3.6" Mini Flood Light	—	—	—	—
FLTWL36009SP	High Output, 1600 Lumen, 9 LED	3.6" Mini Spot Light	—	—	—	—
FLTWL38009FL	High Output, 1600 Lumen, 9 LED	3.6" Mini Flood Light	—	—	—	—
FLTWL38009SP	High Output, 1600 Lumen, 9 LED	3.6" Mini Spot Light	—	—	—	—
FLTWL38510F	High Output Cube with Side Shooter, 3075 Lumen, 10 LED	3.8" Flood Light	—	—	—	—
FLTWL44036FL	High Output Square with Temperature Control, 3528-4272 Lumen, 36 LED	4.4" Flood Light	—	—	—	—
FLTWL46036FL	High Output Round with Temperature Control, 3528-4272 Lumen, 36 LED	4.6" Flood Light	—	—	—	—
FLTWL36020FL	High Output Square with Temperature Control, 3528-4272 Lumen, 20 LED	3.6" Flood Light	—	—	—	—
FLTWL38024FL	High Output Round with Temperature Control, 3528-4272 Lumen, 24 LED	3.6" Flood Light	—	—	—	—
TLD81374	81 Series, Round, White, 6 Diodes, 500 Lumen, Blunt Cut, 10V - 30V	4" LED Work Lamp	—	18K90	—	81374
TL81360	81 Series, Round LED Work Light, Black, 500 Lumen, Stripped End, 10V - 30V, 6 Diodes	4" LED Work Lamp	—	740-170	—	81360
TLD610W	Signal-Stat Rectangular, Black, 1 Bulb, 1450 Lumen, Blunt Cut, 12V	4" x 6" Halogen Work Lamp	—	63151-5	—	610W
TLD80220	Round, Black, 500 Lumen, Stripped End, 12-36V, 8 Diodes	4" LED Work Lamp	—	36-360650	—	80220
TLD80378	PAR 36, Round, Black, 1 Bulb, S/A Wire with MLD BLLT, 12V	5" Incandescent Work Light	—	80378	—	80378
TLD80492	80 Series, Two Beam Rectangular, Black, 2 Bulb, 1450 Lumen, Stripped End, 12V	4" x 6" Halogen Spot Lamp	—	R2518144	—	80492
TLD80498	Two Beam Rectangular, Black, 2 Bulb, 1450 Lumen, Stripped End, 12V	4" x 6" Halogen Spot Lamp	—	18K733	—	80498
FLT4509	4509 PAR 36 Sealed Beam Spot Lamp 12V 100W	Exterior Spot Lamp	—	—	4509	—
OPTTLL50FB	LED Rec Tract, Economy, 9 Diodes	4" x 6" Flood Light	TLL50FB	—	—	—
OPTTLL51FB	LED, Stainless Steel Mount, 12.8-36V	1" x 10" Mini Flood Light	TLL51FB	—	—	—
OPTTLL45FB	LED Round Tract, 8 Diodes	4.5" Flood Light	TLL45FB	—	—	—



SAFETY WARNING LIGHTING



STROBES AND FLOODS	
PN	DESCRIPTION
FLTSW38601A	5" Class 1 Amber Surface Mounted Strobe Light, 6 LED
FLTSW38601AW	5" Class 1 Amber/White Surface Mounted Strobe Light, 6 LED
FLTSW40024A	4" Round Amber Strobe Light, Grommet Mount Style, 24 LED
FLTSW60024A	6" Oval Amber Strobe Light, Grommet Mount Style, 24 LED
FLTSW3810AW	High Output Cube Dual Series Flood Light with Side Shooter, 10 LED
FLTSW42018AW	High Output Square Flood, Strobe Light with Temperature Control, 2200-4000 Effective White Lumen, 18 LED
FLTSW42118AW	High Output Round Flood, Strobe Light with Temperature Control, 2200-4000 Effective White Lumen, 18 LED

CAB MARKER



ALL-MAKES MARKERS		
PN	DESCRIPTION	APPLICATION
FLTCBN52003A	International Oval Amber Cab Marker, 3 LED	International
FLTCBF63203A	Freightliner Post 2014 Cascadia Amber Cab Marker, 3 LED	Freightliner Cascadia
FLTCBF63002A	Freightliner Cascadia Amber Cab Marker, 2 LED	Freightliner Cascadia
FLTCBF42002A	Freightliner M2 Amber Cab Marker, 2 LED	Freightliner M2
FLTCBP46003AC	PACCAR Amber/Clear Cab Marker, 3 LED	PACCAR
FLTCBP10403A	PACCAR Amber Cab Marker, 3 LED	PACCAR
FLTCBV65004A	Volvo VNL Amber Cab Marker, 4 LED	Volvo
FLTCBF40004A	Freightliner Rectangular Amber Cab Marker, 4 LED	Freightliner

BULBS



BULBS

PN	DESCRIPTION	APPLICATION	GROTE X-REF	GE/TUNGSRAM X-REF	TRUCK-LITE X-REF
FLT3157NA	3157NA	Replacement Bulb	—	3157NA	—
FLTH1155WLL	H1155W Long Life	Replacement Bulb	—	1155WLL	—
FLT9007	9007	Replacement Bulb	—	9007	—
FLT194	194	Replacement Bulb	—	194	—
FLT9007LL	9007 Long Life	Replacement Bulb	—	9007LL	—
FLT9006XSLL	9006XS Long Life	Replacement Bulb	—	9006XSLL	—
FLT3157	3157	Replacement Bulb	—	3157	—
FLT194NA	194NA	Replacement Bulb	—	194NA	—
FLT1157	1157	Replacement Bulb	—	1157	—
TL80571	Halogen, 55 Watt, Driving Light, Flood Light, Fog Light, Spot Light, Work Light, 12V	Replacement Bulb	80571	—	80571
FLTH1155W	H11 55W Halogen Headlamp Capsule, 12V	Exterior Headlamp	—	H1155	—
FLT9007	9007 65W/55W Halogen Headlamp Capsule	Exterior Headlamp	—	9007	—
FLT9006	9006 55W Halogen Headlamp Capsule	Exterior Headlamp	—	9006	—
ZBJD947914	LED Bulb Standard #1156, Bayonet Base	#1156 LED	ZBJD947914	—	—
ZBJD948514	LED Bulb Standard #3157, Wedge Base	#3157 LED	ZBJD948514	—	—
ZBJD947514	LED Bulb Standard #194, Wedge Base	#194 LED	ZBJD947514	—	—
ZBJD947715	LED Bulb Standard #211, Festoon Base	#211 LED	ZBJD947715	—	—



Fleetrite® LED Lighting Meets High Standards

Fleetrite LED lighting meets or exceeds DOT and SAE standards. The electronics are sealed and coated for moisture and corrosion resistance, and include high-impact, polycarbonate lenses.

Comprehensive LED lighting program, with product categories including

- Clearance Markers (Grommet Mounted, Surface Mounted)
- Stop/Turn/Tail, Park Turn
- Backup, License, Utility
- Connectors and Mounting Accessories
- Cab Markers
- Work lights

Quality and Durability

- Meets or exceeds DOT and SAE standards
- High-impact, polycarbonate lenses
- Sealed and coated electronics for moisture and corrosion resistance
- Direct OEM-style replacement lights designed to fit factory vehicle harness
- New and innovative technologies, like engineered lens optics for optimum light dispersion

Why choose Fleetrite LED?

- Low power consumption, reducing load on vehicle systems
- Higher energy efficiency, leading to cost savings on fuel
- Lower heat output prolongs light's lifetime
- Durable material and exceptional design

fleetrite.com



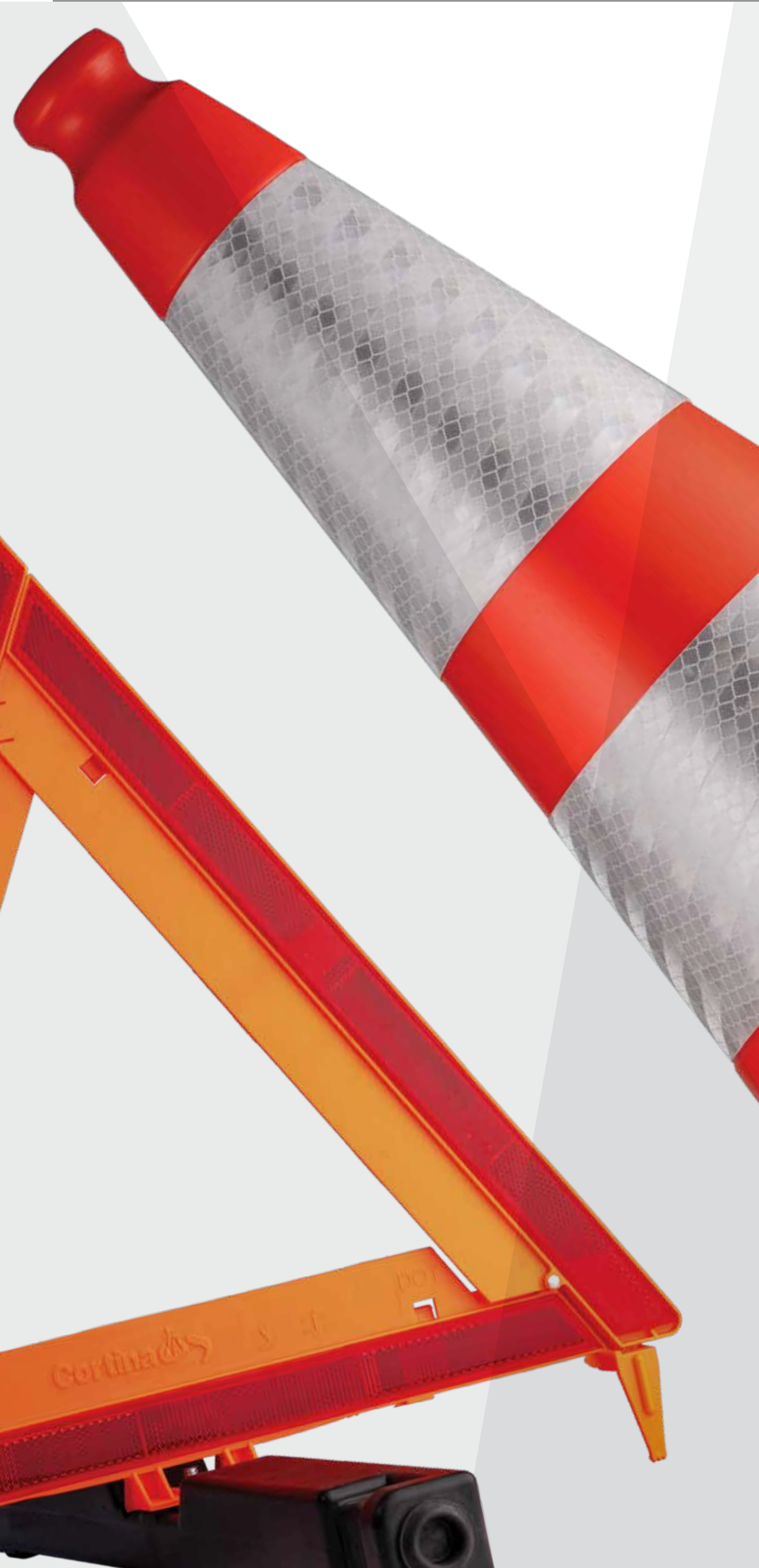

A LOW COST AND EFFECTIVE WAY TO PROTECT THE ENTIRE TEAM.

Our collection of industrial safety items are simple yet cost effective solutions to direct traffic, ensure safety and stay clean!

Order online at RepairLinkShop.com

PARTS FIT TO PERFORM

fleetrite.com



SAFER FLEETS AND SAFER ROADS FOR ALL.

Don't just record collisions. You can help prevent them with Nauto®.

HELP KEEP DRIVERS SAFE AND PROTECT THEIR PRIVACY

nauto.com

CARGO CONTROL



STRAPS AND TRACKS

PN	DESCRIPTION	APPLICATION/WORKING LOAD LIMIT	KINEDYNE X-REF	MULTIPRENS X-REF
FLTWSF66180	4" x 30' Winch Strap with Flat Hook	Flatbed Straps/5,400 Lbs. Flatbed Strap/5,400 Lbs.	423021	2042-30
FLTWSJ22737	4" x 30' Winch Strap with J Hook	Flatbed Straps/5,000 Lbs.	483036	2046-30
FLTWSD22733	4" x 30' Winch Strap with Delta Ring	Flatbed Straps/5,000 Lbs.	423010	2041-30
FLTRTF66197	4" x 30' Ratchet Strap with Flat Hook	Flatbed Straps/5,400 Lbs.	593021	5942-30
FLTRTJ66198	4" x 30' Ratchet Strap with J Hook	Flatbed Straps/5,400 Lbs.	593036	5946-30
FLTRTF66186	2" x 27' Ratchet Strap with Flat Hook	Flatbed Straps/3,333 Lbs.	572720	5822-27
FLTRTJ66187	2" x 27' Ratchet Strap with J Hook	Flatbed Straps/3,333 Lbs.	9227D4	5826-27
FLTRSW66189	2" x 30' Ratchet Strap with J Hook	Flatbed Straps/3,333 Lbs.	513060	5826-30
FLTRSF66190	2" x 30' Wide Handle Ratchet Strap with Flat Hook	Flatbed Straps/3,333 Lbs.	573020	5822-30
FLTCG79007	3/8" x 20' Chain with Clevis Grab Hook	Flatbed Tie Down/6,600 Lbs.	10038-20BX	4438-20-D
FLRLBG66097	5/6" - 3/8" Ratchet Binder with Grab Hook	Flatbed Tie Down/6,600 Lbs.	10035	4378
FLRLBG66067	3/8" - 1/2" Ratchet Binder with Grab Hook	Flatbed Tie Down/11,000 Lbs.	10035HD	4448
FLTEPDM66104	21" EPDM Rubber Strap	Light-Duty Tie Down	2221EPD	5421
FLTEPDM66100	10" EPDM Rubber Strap	Light-Duty Tie Down	2210EPDM	5409
FLTEPDM66102	15" EPDM Rubber Strap	Light-Duty Tie Down	2215EPDM	5415
FLTEPDM66106	31" EPDM Rubber Strap	Light-Duty Tie Down	2231EPDM	5431
FLTEPDM66108	41" EPDM Rubber Strap	Light-Duty Tie Down	2241EPDM	5441
FLTET30130	10' Galvanized Horizontal E Track	Trailer Tie Down	43001	6201-10
FLTET30135	5' Galvanized Horizontal E Track	Trailer Tie Down	—	—
FLTEFCB66170	2" x 12' E Cam Buckle	Trailer Tie Down	651201	6126-12
FLTEFR66175	2" x 12' E Track Strap with Ratchet	Trailer Tie Down	641201	6226-12
FLTSTCB70195	Steel Tube Cargo Bar with 2 Pads	Trailer Tie Down	10085	CB-301



FENDERS, MUDFLAPS AND ACCESSORIES



FENDERS, MUDFLAPS AND ACCESSORIES

PN	DESCRIPTION	APPLICATION	TRP X-REF	ROAD CHOICE X-REF	BETTS X-REF	FLEET ENGINEERS X-REF	MINIMIZER X-REF
FLT03100406	Fleetrite Poly Quarter Fender	All-Makes	—	—	—	—	—
FLTCR21960	Spring-Loaded Mudflap Hanger, 30", Straight, Chrome	All-Makes	—	—	—	—	—
FLTCR21990	Spring-Loaded Mudflap Hanger, 30", 45 Degree Angle, Chrome	All-Makes	—	—	—	—	—
FLTCR21961	Spring-Loaded Mudflap Hanger, 30", Straight, Stainless	All-Makes	—	—	—	—	—
FLTCR22012	Spring-Loaded Mudflap Hanger, 27", 45 Degree Angle, Black	All-Makes	—	—	—	—	—
FLP5040131	Poly Full Tandem Fender, WBT Pair	All-Makes	—	—	—	—	MIN4020
FLP5345131	Poly Full Tandem Fender, Pair	All-Makes	FF00113	FTF5345131P	PF400-132X	031-01646	—
FLPFF7125	Poly Roll-Off Full Tandem Fender, Single	All-Makes	FF00223	FTF7125P	—	—	MIN200
FLPFF7225	Poly Tri-Axle Extender, Pair	All-Makes	FF00303	FTF72251P	—	—	MIN300
FLP502066	Poly Half Tandem Fender, WBT Pair	All-Makes	—	—	PF100-60	—	MIN9070
FLP532566	Poly Half Tandem Fender, Pair	All-Makes	HF00083	HTF532566P	PF300-66	031-01639	MIN1550
FLPMNT16501	Universal Center Mount, LH	All-Makes	FB00145	FMC16501	B900S	—	—
FLPMNT16502	Universal Center Mount, RH	All-Makes	FB00155	FMC16502	B900G	—	—
FLPMNT16507	Universal Wide Tire Center Mount, LH	All-Makes	—	FMC16507	—	—	—
FLPMNT16508	Universal Wide Tire Center Mount, RH	All-Makes	—	FMC16508	—	—	—
FLPMNTFL360	Universal Swivel Mount Bracket, EA	All-Makes	—	FMCFL360	—	—	—
FLP160018M	8" Post Mount, 8 Pack	All-Makes	FB00645	—	X2900	031-00235	—
FLPMK4005	Single Axle Mounting Kit, U-Bolt	All-Makes	FH00015	SAF4000MK	K2363UG	—	103144
FLPMK4055	Single Axle Mounting Kit, Poly Bracket	All-Makes	—	SAF4055MK	—	031-02039	—
FLPMK4235X	Half Tandem Mounting Kit, U-Bolt	All-Makes	FB00025	HTF4235XMK	K3363UG	—	103143
FLPMK4255	Half Tandem Mounting Kit, Poly Bracket	All-Makes	—	—	—	—	—
FLPMK4255X	Half Tandem Mounting Kit, Poly Bracket	All-Makes	—	HTF4255XMK	—	—	—
FLPMK4435X	Full Tandem Mounting Kit, U-Bolt	All-Makes	FB00055	FTF4435XMK	K4363UG	—	103100
FLPMK4455X	Full Tandem Mounting Kit, Poly Bracket	All-Makes	—	FTF4455XMK	—	—	—



FENDERS, MUDFLAPS AND ACCESSORIES (CONT'D)



FENDERS, MUDFLAPS AND ACCESSORIES

PN	DESCRIPTION	APPLICATION	TRP X-REF	ROAD CHOICE X-REF	BETTS X-REF	FLEET ENGINEERS X-REF	MINIMIZER X-REF
FLP1585BBULK	Stainless Steel Braceless Quarter Fender, Bulk	All-Makes	QT00071BULK	—	—	—	—
FLP1900BULK	Poly Quarter Fender, Bulk	All-Makes	QT00213BULK	—	—	—	—
FLP1585BKIT	Stainless Steel Braceless Quarter Fender, Pair	All-Makes	QT00071	QF1585B	SS212PA2	031-01070	—
FLP1585FBKIT	Stainless Steel Full Brace Quarter Fender, Pair	All-Makes	QT00101	QF1585FB	—	—	—
FLP1585HBKIT	Stainless Steel Half Brace Quarter Fender, Pair	All-Makes	QT00131	QF1585HB	PS221PA2	—	—
FLP1585LMKIT	Stainless Steel Low Mount Half Brace Quarter Fender, Pair	All-Makes	QT00171	QF1585LM	SS222PA2	031-01074	—
FLP1900KIT	Poly Quarter Fender, Pair	All-Makes	QT00213	QF1900	PS214PA2	031-01636	MIN1400
FLP500077	Poly Single Axle Fender WBT, Pair	All-Makes	—	SAF500077P	—	031-01539	MIN1600
FLP500576	Poly Single Axle Fender, Pair	All-Makes	SA00053	SAF500576P	PF200-80	031-01700	MIN2480
FLPFF30PKIT	30" Painted Hanger Bracket 2.5" Bolt Space, Pair	All-Makes	FB00215	MFB30P	B703000NTBK	033-00868	—
FLPFF30SSCXKIT	30" Stainless Steel Hanger Bracket with CX 2.5" Bolt Space, Pair	All-Makes	FB00251	MFB30SSCX	B80300RTSK	033-05193	—
FLPFF30SSKIT	30" Stainless Steel Hanger Bracket 2.5" Bolt Space Pair	All-Makes	FB00241	MFB30SS	B703000NTSK	033-00870	—
FLPSF3045PCXKIT	27" Painted Angled Hanger Bracket with CX 1.125" Bolt Space, Pair	All-Makes	FB00405	MFB3045PCX	B672625WTBK	033-05194	—
FLPSF3045PKIT	27" Painted Angled Hanger Bracket 1.125" Bolt Space, Pair	All-Makes	FB00395	MFB3045P	B672625NTSK	033-00864	—
FLPSF3045SSCXKIT	27" Stainless Steel Angled Hanger Bracket with CX 1.125" Bolt Space, Pair	All-Makes	FB00461	MFB3045SSCX	B672625WTSK	033-04546	—
FLPSF3045SSKIT	27" Stainless Steel Angled Hanger Bracket 1.125" Bolt Space, Pair	All-Makes	FB00451	MFB3045SS	B672625NTSK	033-04546	—
FLPSF3145PCXKIT	31.5" Painted Angled Hanger Bracket with CX 1.125" Bolt Space, Pair	All-Makes	—	MFB3145PCX	—	—	—
FLPSF3345PCXKIT	30" Painted Angled Hanger Bracket with CX 1.125" Bolt Space, Pair	All-Makes	—	MFB3345PCX	—	—	—
FLPSF3145SSCXKIT	31.5" Stainless Steel Angled Hanger Bracket with CX 1.125" Bolt Space, Pair	All-Makes	—	MFB3145SSCX	—	—	—
FLPSF3345SSCXKIT	30" Stainless Steel Angled Hanger Bracket with CX 1.125" Bolt Space, Pair	All-Makes	FB00551	MFB3345SSCX	—	—	—
FLPBF30PCXKIT	30" Painted Hanger Bracket with CX, 1.125" Bolt Space, Pair	All-Makes	—	MFB30PCX	B703000NTBK	033-05192	—
FLPBF31PCXKIT	31.5" Painted Hanger Bracket with CX, 1.125" Bolt Space, Pair	All-Makes	—	MFB31PCX	—	—	—
FLPBF30SSCXKIT	30" Stainless Steel Hanger Bracket with CX, 1.125" Bolt Space, Pair	All-Makes	—	MFBBF30SSCX	—	—	—
FLPBF31SSCXKIT	31.5" Stainless Steel Hanger Bracket with CX, 1.125" Bolt Space, Pair	All-Makes	—	MFB31SSCX	—	—	—
2518142C91	LT Floor Mat Set	LT Truck Models	—	—	—	—	—
251998191	MV Floor Mat Set	MV Truck Models	—	—	—	—	—
2519980C91	HV Floor Mat Set	MV Truck Models	—	—	—	—	—
2518144C91	HX Floor Mat Set	HX Pre-Mid 2019 Model Change	—	—	—	—	—
2518143C91	RH Floor Mat Set	RH Truck Models	—	—	—	—	—



FIRST AID



FIRST AID

PN	DESCRIPTION	APPLICATION	CERTIFIED SAFETY X-REF
FLTSM1STAI1	Small First Aid Kit, ANSI Compliant, Prefilled	First Aid	6400C
FLTSLG1STAI2	3-Shelf Wall Mount First Aid Kit, Prefilled	First Aid	K615-025



MISCELLANEOUS



MISCELLANEOUS ITEMS

PN	DESCRIPTION	APPLICATION	AMERICAN LOCK X-REF
FLTSILOCK1	Aluminum Lock, 1" Steel Shackle	Lockout Devices	A1105GRN
FLTSILOCK2	Aluminum Lock, 4" Flexible Cable	Lockout Devices	—
FLTSIHASP6	1-1/2" Opening Diameter Hasp, Holds up to 6 Locks	Lockout Devices	—
FLTSIDLOCK3	Diskus Lock, with Key	Lockout Devices	—
FLTSILEDB9	LED Baton 9", 3-Way Switch, Belt Clip	Traffic Safety	—
FLTSILEDB12	LED Baton 12", 3-Way Switch, Belt Clip	Traffic Safety	—
FLTSIFLG18	Wood Handle, Orange Vinyl Flag, 18"	Traffic Safety	—
FLTSITRI1	Triangle Warning Kit	Traffic Safety	—

**We Have It All**

A one-stop shop for all must-have safety items to protect you and your truck at all times.

fleetrite.com

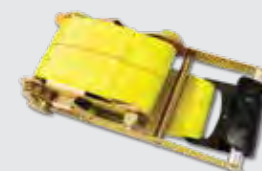
**Fleetrite® Nitrile Gloves – Great for Cleaning Your Vehicle**

Fleetrite nitrile gloves are fully textured, latex-free, powder-free, 6-mil thickness, industrial grade; perfect for cleaning, painting and servicing your vehicle or Fleet!

fleetrite.com

**Fleetrite® Warning Triangles**

Opaque container protects fluorescent color from UV deterioration. Weighted base ensures triangles will not move by wind gusts caused by passing traffic. Fleetrite's warning triangle meets or exceeds all DOT FMVSS125 requirements

fleetrite.com





**WHEN YOU COMPARE,
MERITOR IS KING.**

Meritor® high-quality no-ream king pin kits. Designed to reduce repair time and maintenance.

meritorpartsexpress.com



MONROE MAGNUM SEVERE SERVICE SHOCKS.

Designed for hardworking emergency, municipal, fleet and jobsite vehicles, Monroe® Magnum Severe Service shocks have a larger bore for greater working capacity and arc-welded mounts for higher tensile strength.

monroe.com

STEERING



STEERING GEARS (U.S.)

PN	DESCRIPTION	APPLICATION	OE REMAN X-REF	WELLER X-REF	MASCOT X-REF	TRW X-REF
RSGTAS66001	TRW Steering Gear	International	TAS66001	—	—	TAS66001R
RSGHD94PQ3	Steering Gear	—	HD94PQ3	—	—	—
RSGTAS40042	TRW Power Steering Gear	International	TAS40042A	TAS40042WEL	TAS40042	TAS40042R
RSGM80SAW1	Steering Gear	International	ZRXM80SAW	M80SAW1WEL	M80SAW1	—
RSGM100PTD3	Steering Gear	—	M100PTD3	—	—	—
RSGTAS66004	TRW Power Steering Gear	International	TAS66004	—	—	TAS66004R
RSGM100PMT3	Power Steering Gear, International 4300, 2-Hose Ports, 4 Mounting Holes	International	M100PMT	M100PMT3WEL	M100PMT3	—



STEERING GEARS W (CAN)

PN	DESCRIPTION	OE REMAN X-REF	TRW X-REF
RCTAS40042	TRW TAS40042 Steering Gear	TAS40042	TAS40042R
RCTAS66001	TRW TAS66001 Steering Gear	TAS66001	TAS66001R
RCTAS66004	TRW TAS66004 Steering Gear	TAS66004	TAS66004R
RCTAS66003	TRW TAS66003 Steering Gear	TAS66003	TAS66003R
RCPCF60003	TRW PCF60003 Steering Gear	PCF60003	PCF60003R
RCM80SAW1	Sheppard M80SAW1 Steering Gear	M80SAW1	—
RCM100PMX1	Sheppard M100PMX1 Steering Gear	M100PMX1	—



FLEETRITE KING PIN KITS

PN	DESCRIPTION
FLTKP5454	King Pin Kit with Ream, Axle, Front, Composite, 1.359" x 7.79"
FLTKP4572	King Pin Kit with Ream, Axle, Front, Composite, 1.625" x 9.20"
FLTKP5455	King Pin Kit with Ream, Axle, Front, Composite, 1.921" x 9.87"
FLTKP4570	King Pin Kit with Ream, Axle, Front, Composite, 1.7935" x 10.39"
FLTRLKP981R	King Pin Kit without Ream, Steel, 1.794" x 8.87"
FLTKP4568	King Pin Kit with Ream, Axle, Front, Composite, 1.999" x 11.21"
FLTKP5500	King Pin Kit with Ream, Axle, Front, Composite, 1.8725" x 9.065"
FLTRLKP102I	King Pin Kit without Ream, without Caps
FLTRLKP103S	King Pin Kit without Ream, without Caps
FLTRLKP110G	King Pin Kit without Ream, without Caps
FLTRLKP120A	King Pin Kit without Ream, without Caps
FLTRLKP120E	King Pin Kit without Ream, without Caps
FLTRLKP120G	King Pin Kit without Ream, without Caps
FLTRLKP120I	King Pin Kit without Ream, without Caps
FLTRLKP120R	King Pin Kit without Ream, without Caps
FLTRLKP121E	King Pin Kit without Ream, without Caps
FLTRLKP122E	King Pin Kit without Ream, without Caps



MERITOR KING PIN KITS WITH REAM

PN	DESCRIPTION	APPLICATION
R201331	King Pin Kit, Easysteer	Eaton/Dana 02ADA, 02ADB, 02AEM 2022 and Earlier
R201486	King Pin Kit, Easysteer	Eaton/Dana 02ADD, 02ADG, 02ADN, 02ADP
R201315	King Pin Kit, Easysteer	Meritor FF961, FF941
R201609	King Pin Kit	Meritor MFS+
R201631	King Pin Kit, Easysteer	Meritor MFS+
R201475	King Pin Kit, Easysteer	Meritor MFS16, MFS18
R201309	King Pin Kit, Easysteer	Meritor FG931, FG933, FG940 (02ARG), FG941, FG943, FG941
R201608	King Pin Kit	Meritor MFS+
R201476	King Pin Kit, Easysteer	Meritor MFS16, MFS18, MFS20
R201474	King Pin Kit, Easysteer	Meritor MFS08
R201312	King Pin Kit, Easysteer	Meritor FL931, FL933, FL941, FL943
R201319	King Pin Kit, Easysteer	Meritor FG931, MFS13, MFS14

MERITOR NO-REAM KING PIN KITS

PN	DESCRIPTION	APPLICATION
R202001	FastSet™ No-Ream King Pin Kit	Eaton/Dana E1200I/W, E1320I/W
R202002	FastSet™ No-Ream King Pin Kit	Meritor FF961, FF941
R202003	FastSet™ No-Ream King Pin Kit	Meritor FF981, MFS10, MFS12, MFS13
R202004	FastSet™ No-Ream King Pin Kit	Eaton/Dana 02ADD, 02ADG, 02ADN, 02ADP
R202005	FastSet™ No-Ream King Pin Kit	Eaton/Dana 02ADA, 02ADB, 02AEM 2022 and Earlier
R202006	FastSet™ No-Ream King Pin Kit	Eaton/Dana E1202I/W, E1322I/W, E1462I/W
R202007	FastSet™ No-Ream King Pin Kit	Eaton/Dana EFA12F4
R202008	FastSet™ No-Ream King Pin Kit	Meritor FH941, FH945, FH946
R202009	FastSet™ No-Ream King Pin Kit	Eaton/Dana 02AEM 2002 – Current
R202010	FastSet™ No-Ream King Pin Kit	Meritor FG931, MFS13, MFS14

SUSPENSION



TORQUE RODS

PN	DESCRIPTION	APPLICATION	OE PART X-REF	DAYTON X-REF	AUTOMANN X-REF	FREIGHTLINER X-REF	HENDRICKSON/WATSON & CHALIN X-REF	PACCAR X-REF	GAFF PN
R303277	Adjustable Torque Arm, 18-1/2" - 21" Center-to-Center	Hutch H7700, H9700	16398-04	345-164E	TR004	—	—	—	—
R302899	Rigid Torque Arm, 19-1/4" Center-to-Center	Hutch H7700, H9700	715-00	345-167	TR005	—	—	—	—
R304824	Adjustable Torque Arm with Bushings	SAF Holland/Binkley Duralite™	SP0123	345-157	TR009	—	—	—	—
R304771	Torque Arm, 23" Center-to-Center	Peterbilt Air Leaf	03-04059	345-210	TMR518	—	—	—	—
R3015536	Rigid Torque Arm, 24-3/8" Center-to-Center, E-15536 includes E-5275 Bushings	Freightliner FASII	681-326-67-16	—	—	—	—	—	—
R3015542	Rigid Torque Arm, 24-1/2" Center-to-Center, E-15542 includes E-5275 Bushings	Freightliner FASII	16-16749-002	345-868	TMR535	—	—	—	—
R3016262	Torque Rod Fastener and Alignment Kit, One Wheel End	Hendrickson Primaax EX	58821-011	—	—	—	—	—	—
R3010303	Torque Arm and Stabilizer Rod Bushing, Rubber, Straddle Mount	Kenworth AirGlide 200-400	836940	321-369	TRB6825	—	—	—	—
R303988	Transverse Torque Arm Kit, Full Ball Design	Mack Camelback	—	345-805	—	—	—	—	—
R308821	Torque Arm, 22-1/8" Long, Straddle Mount Bushings, E-8821 includes E-9395 Bushings	Mack and Volvo Corporate Air	35801-0068	345-219	TMR531	—	—	—	—
R303176	Torque Arm Kit, Full Ball Design	Mack and Volvo Corporate Air	—	345-803	—	—	—	—	—
R305082	Torque Arm with 5/8" Hole In Both Bushings, 17-11/32" Center-to-Center, includes E-2226 Bushings	Peterbilt Air Trac	03-04119	345-196	TMR517	—	—	—	—
R305083	Torque Arm with 5/8" Hole Hanger End, 3/4" Hole Axle End, 17-11/32" Center-to-Center, includes (1) E-2226 and (1) E-3868 Bushing	Peterbilt Air Trac	03-04327	345-211	TMR520	—	—	—	—
R3015709	Transverse Torque Arm, 25-1/2" Center-to-Center, New Torque Arms Are Not Rebushable. Older Torque Arms Use E-5275 Bushings	Peterbilt Flex Air	C65-6002, C65-6009	345-884	—	—	—	—	—
R3016098	Torque Arm, Front, 23-3/4" Center-to-Center, Not Rebushable	Peterbilt Flex Air	C65-6000-001	345-882	TMR537	—	—	—	—
R3016099	Torque Arm, Rear, 24 5/8" Center-to-Center, Not Rebushable	Peterbilt Flex Air	C65-6000-002	345-883	TMR539	—	—	—	—
R302855	Torque Arm, Rigid, without Bushings, Rear 44" Axle Spacing, Front 49" - 109" Axle Spacing	Reyco 21B Cast	15178-01, T-7635	345-110	TR031	—	—	—	—
R309307	Rigid Torque Arm with E-1980 Bushings	SAF Holland/Binkley Duralite™	SP0143	345-134	TR005B	—	—	—	—
R309308	Torque Arm Bolt and Nut Assembly	SAF Holland/Binkley Duralite™	—	334-827	—	—	—	—	—
ATRTR55428C1	Torque Rod, Small Eye 25-3/8" Center-to-Center	International Corporate Air	3580088C2	345-904	TMR533	—	—	—	GAFF34563
TR5042565	Torque Rod, 22-1/4" Center-to-Center	Freightliner	62000-565, 62011-565	345-898	TMR617E	813263516	7428565	67428565	—
ATRTR4641000	Torque Rod, 24-3/16" Center-to-Center	Freightliner FASII	—	—	—	16-15632-000	—	—	GAFF11152
ATRTR4641002	Torque Rod, Small Eye 24-5/16" Center-to-Center	Freightliner FASII	—	—	TMR536	16-18972-000	—	—	GAFF11081
ATRTR5042565	Torque Rod, 22-1/4" Center-to-Center	Hendrickson Primaax and Others	—	—	TMR617	—	62000-565	—	—
ATRTR4641000	Torque Rod, Freightliner 16-15632000	Freightliner	062-011-10	345-167	TR005	—	12954	—	—
ATRTR0041009	Torque Rod, Small Eye 25-9/16" Center-to-Center	Kenworth 380, Peterbilt Flex Air/New Low Air Leaf	—	345-884	TMR553	—	—	C65-6020	GAFF11792



Free-Rotation Torque Rod Bushings

Did you know that almost all of ATRO's bushing feature a rotating pin? This makes installation easier, eliminates bushing wind up and reduces stress on the entire suspension. Since polyurethane is not affected by contaminants, ATRO bushings will last longer and hold up to the stresses of the heavy duty trucking industry.

ATRObushing.com



Fleetrite® King Pin Kits Cover 95% of Trucks

Fleetrite king pin kits cover 95% of trucks on the road with over 5,000 make/model applications. Installation is easy with no reaming or pressing-in of bushings required.

fleetrite.com



SUSPENSION (CONT'D)



BUSHINGS AND KITS

PN	DESCRIPTION	APPLICATION	OE PART X-REF	DAYTON X-REF	AUTOMANN X-REF	ATRO X-REF	MERITOR X-REF	HENDRICKSON X-REF
R307766	Torque Arm Bushing, Rubber, Type 2 Joints	Chalmers 800	800010	321-276	TRB8644	—	—	—
R307767	Torque Arm Bushing, Rubber, Oversized, Type 2 Joints	Chalmers 800	800009	321-277	TRB8645	—	—	—
R307768	Spigot Cap, Type 2 Joints	Chalmers 800	800055	334-855	M18004	—	—	—
R3015541	Spring Eye Bushing, Anti-Walk	Freightliner FASII	16-16412-001	RB-268	MR782	—	—	—
R3014025	Quik-Align® Pivot Bushing Service Kit, Except for 12-1/2" or Larger Ride Heights with Disc Brakes, includes Hardware and Bushing	Hendrickson Primaax EX	60632-020	334-1698	MHS85	—	—	—
R3014033	Quik-Align® Collar, Pivot Bushing and Single Bolt Torque Rod Service Kit, 12-1/2" Ride Height and Larger with Disc Brakes, Axle Set, includes Hardware and Pivot Bushing	Hendrickson Primaax EX	60632-022	334-1705	MHS235	—	—	—
R3016091	Torsion Bar Bushing, 54mm Bar Diameter, 40K Models, Rubber, Improved OE Version	Kenworth AirGlide 200-400	C13-1004	—	—	—	—	—
R3016092	Torsion Bar Bushing, 58mm Bar Diameter, 46K Models, Rubber, Improved OE Version	Kenworth AirGlide 200-400	C13-1005	—	—	—	—	—
R302225	Spring Eye Bushing, Straddle Mount, 2-1/2" OD, 4-3/8" Center-to-Center, 5/8" Bolt Holes	Mack and Volvo Corporate Air	35033-3201	321-131	TRB6164	—	—	—
R3015671	Spring Eye Bushing, High Confinement, Straddle Mount, 2 1/2" OD, 4-3/8" Center-to-Center, 5/8" Bolt Holes	Mack and Volvo Corporate Air	8079894	—	—	—	—	—
R3016777	Spring Eye Bushing, Through Hole, 7/8" ID x 2-9/16" OD x 3-9/16" Long 2006 - Current	Mack and Volvo Corporate Air	20558810	—	—	—	—	—
R3017006	Front Pivot Bushing Kit, includes Bushing, Bolts, Washers and Nuts	Kenworth AirGlide 210	—	—	—	—	—	—
R304773	Spring Eye Bushing Kit, includes Bushing, Spacers and Hardware	Peterbilt Air Leaf	03AL1	334-460	TRK5905	—	—	—
R307854	Spring Roller Bushing Kit, includes Bushing, Spacers and Hardware	Peterbilt Air Trac	—	—	MPB66	—	—	—
R3016094	Spring Eye Bar Pin Bushing	Peterbilt Flex Air	C13-6001	—	—	—	—	—
R3016097	Spring Eye Hollow Bushing	Peterbilt Flex Air	C65-1002, C13-6002	—	—	—	—	—
R3010729A	Tri-Function Bushing Kit - Quik-Align®, includes Bushing and Hardware All Models Except AANL and AANLS	Hendrickson INTRAAX®/VANTRAAX®	S-24691	334-1576	MHS736	—	—	—
R3014377	Tri-Function Bushing Kit - Quik-Align®, includes Bushing and Hardware for 1 Axle. AANL and AANLS Models	Hendrickson INTRAAX®/VANTRAAX®	S-26321	334-1628	MHS745	—	—	—
R303079	Torque Arm Bushing, Rubber and Bolt Kit Assembly, includes Bushing and Hardware	Hutch H7700-H9700	—	334-344	TRK6326	—	—	—
R303976	Equalizer Bushing Assembly, includes Rubber Bushing and Hardware	Reyco 21B Cast	TK18998	334-211	TRK5066	—	—	—
GAFF10075	Motor Mount	International Truck F6, F7, F8, W900	—	329-150U	—	PL1048	—	—
GAFF11081	Torque Rod, Small Eye 24-5/16" Center-to-Center	Freightliner FASII	16-18972-000	—	—	—	—	—
GAFF11083	Spring Pin Bushing	Freightliner FASII Airliner	—	RB-268U	—	PB46-26268	—	—
GAFF11089	Motor Mount Kit	Freightliner FLD120, Century, Columbia	—	—	—	MM4662000	—	—
GAFF11502	Stabilizer Bushing, Poly	Kenworth Series AirGlide 100	—	320-150U	—	PL1008	—	—
GAFF11517	Fifth Wheel Bushing	SAF Holland/Neway Series FR175, FW3510, FW070, FW3500, FW3100	—	329-104U	—	PL1006	—	—
GAFF11523	Cab Mount	Kenworth W-900	—	—	—	PL1015-HT	—	—
GAFF11540	Motor Mount	Kenworth T600	—	—	—	KT59-62001	—	—
GAFF11545	Hood Guide	Kenworth T600, T800	—	329-129	—	PL1011	—	—
GAFF11554	Air Cooler Mount	Kenworth and Peterbilt	—	329-149U	—	PL1077	—	—
GAFF11611	Shifter Bushing Kit	Kenworth	—	DT1537	—	MS99-63399	—	—
GAFF11615	Motor Mount	Kenworth T-600, W-900	—	—	—	KT59-62002	—	—
GAFF11729	Torque Rod and Stabilizer Rod Bushing, Poly	Kenworth Air Suspension Single Series AirGlide 200, 400, 460, 690	—	321-369U	TRB6825E	TS59-22400	—	—
GAFF11739	Torque Rod Bushing, Poly, Type 2 Joints	Chalmers Series 700, 800, 1000	—	321-276U	TRB8644UB	TH19-22010	—	—
GAFF11740	Load Spring	Chalmers Series 700, 800, 1000	—	325-156U	MLC11UB	LP19-24002	—	—
GAFF11760	Motor Mount Kit	Kenworth T600, T800	—	—	M17411KUB	KT59-62001-HW	—	—
GAFF11762	Motor Mount Kit	Kenworth T-600, W-900	—	—	—	MM5962407HW	—	—
GAFF11811	Exhaust Mount Kit	Kenworth T600, T680, T800, W900	—	—	—	—	—	—
GAFF12014	Lower Insulator Pad, Poly	Mack Series SS34, 38, Series SWS 573	—	325-110U	ABP2UB	MA36000	—	—

SUSPENSION (CONT'D)



BUSHINGS AND KITS (CONT'D)

PN	DESCRIPTION	APPLICATION	OE PART X-REF	DAYTON X-REF	AUTOMANN X-REF	ATRO X-REF	MERITOR X-REF	HENDRICKSON X-REF
GAFF12034	Motor Mount Kit	Mack	—	—	—	KT62-62216	—	—
GAFF12035	Motor Mount Kit	Mack	—	—	—	KT62-62389	—	—
GAFF12036	Load Pad Kit	Mack Series SS34, 38, Series SWS 573	—	—	—	SK50380	—	—
GAFF12039	Load Pad Kit	Mack Series SS 34-44, Series SW ST34	—	—	ABP34UB	SK50340	—	—
GAFF12357	Exhaust Mount	Peterbilt	—	329-214U	—	EM75-69656	—	—
GAFF12364	Hood Mount	Peterbilt 357, 377, 378, 379	—	—	—	HM75-65711	—	—
GAFF12365	Hood Latch	Freightliner M2	—	—	—	HL00-64001	—	—
GAFF12366	Radiator Bushing	Peterbilt 357	—	—	—	PL1126	—	—
GAFF12369	Motor Mount	Peterbilt 379	—	—	—	MM75-62372	—	—
GAFF12395	Torque Rod 5/8", Hanger End 3/4", Axle End, Poly	Peterbilt Air Trac	—	345-211U	TMR520E	TR75-41327	—	—
GAFF13520	Torque Rod Bushing, Straddle Mount, Poly	Hendrickson Series RS 400, 403, 460, 463, Series RT 380, 440, Series RT 340, Series RS/RTE 400, 403, 460, 463	—	321-132U	TRB6820HE	TS38000	—	—
GAFF13626	Bolster Spring Kit, Poly	Hendrickson Haulmaax	—	334-1727U	—	LP50-24179	—	—
GAFF13628	Suspension Bushing	Hendrickson INTRAAX®/VANTRAAX®, HT, HLM	—	—	MHS736UB	PB50-36100	—	—
GAFF14038	Equalizer Bushing	Hutchens H/CH 7700, 9700	18723-01	—	—	—	—	—
GAFF14523	Trunnion Bushing	SAF Holland/Neway	—	—	—	—	—	—
GAFF18455	Wheel Chock	GAFF	—	—	—	—	—	—
GAFF18860	Torque Rod, Poly	Volvo Truck VNL, VNM	—	345-219U	TMR531E	TR96-41068	—	—
GAFF34510	Motor Mount Kit	International Truck	—	—	—	MM55-62004	—	—
GAFF34525	Motor Mount Kit	International Truck	—	—	—	MM5562005	—	—
GAFF34563	Torque Rod Assembly	International Truck Corporate Air	—	—	TMR533E	TR55-418C1	—	—
GAFF13743	Tri-Function Bushing Kit, Axle Set, Poly	Hendrickson INTRAAX®/VANTRAAX®, HT, HLM	—	334-1628U	MHS745UB	PB50-36322	—	—
ATRPL1046	Chalmers Torque Rod Bushing	Typically Chalmers 46K+ Suspensions	—	321-276U	TRB8645UB	—	R307426	—
ATRPL1047	Chalmers Torque Rod Bushing	Typically Chalmers 40K Suspensions	—	—	TRB6328UB	—	—	—
ATRPL1049	Chalmers Torque Rod Bushing, Oversized	Typically Chalmers 46K+ Suspensions	—	321-277U	TRB8645UB	—	—	—
ATRPL1146	Torque Rod Bushing	Multiple Applications	—	321-223U	TRB6185UB	—	—	47691-000
ARTS34000	Torque Rod Bushing	Multiple Applications	—	321-131U	TRB6164UB	—	—	44694-000
ARTS5022691	Torque Rod Bushing	Multiple Applications	—	—	TRB6189UB	—	—	47691-000
ARTS38000	Torque Rod Bushing	Multiple Applications	—	321-132U	TRB6820	—	—	66649-002
ATRPB4626268	Spring Eye Bushing, Anti-Walk	International, Freightliner, PACCAR	—	RB268U	MR656UB	—	—	—
ATRK5025002	Haulmaax Bolster Kit	Hendrickson Haulmaax Suspension	—	—	—	—	—	64179-000
ATRLP5024000	HN Bolster	Hendrickson HN Suspension	—	—	—	—	—	60879-000
ATRLP5024974	HN Auxiliary Spring	Hendrickson HN Suspension	—	—	—	—	—	64179-004

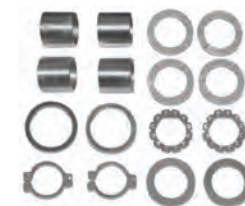

TRUCK LEAF SPRINGS

PN	DESCRIPTION	APPLICATION	DAYTON X-REF
H47057000	4" Wide Rear Spring, 12 Leaves with Pad	Hendrickson RT and RT2 2-Spring Suspension	50-301
H56946000	3" Wide Rear Spring, 1 Leaf	Hendrickson HAS Series	50-389-USA
1680499C91	3" Wide Front Spring, 2 Leaves	International 3000 Series	—
501566C93	3-1/2" Wide Rear Spring, 1 Leaf	International Air Suspension, 5-Hole in Leaf	—
2027488C91	3" Wide Rear Spring, 13 Leaves with RRA 2-Stage	International S-Series, 1000-8000 Series	—
572347C91	3" Wide Front Spring, 6 Leaves with Pad	International S-Series, 1000, 2000, 3000, 4000 and 7000 Series	—



Fleetrite U-Bolts Available in Round, Square and Semi-Round

Fleetrite® U-bolts are available in three configurations: round, square and semi-round. These quality parts are available in a variety of applications including International, Freightliner, Kenworth, PACCAR, and Trailer.

fleetrite.com



SUSPENSION (CONT'D)



AIR SPRINGS

PN	APPLICATION	GOODYEAR X-REF	FIRESTONE X-REF	HENDRICKSON X-REF	MERITOR X-REF
FLTA1R11028	Kenworth	1R11028	FSIW013589422	—	MAF9422
FLTA1R12069	Peterbilt Air Leaf	1R12069	FSIW013589069	—	MAF9069
FLTA1R12092	SAF Holland	1R12092	FSIW013589082	—	MAF9082
FLTA1R121048	SAF 9055	1R121048	FSIW013589974	—	MAF9974
FLTA1R121097	Peterbilt	1R121097	FSIW013588864	—	MAF8864
FLTA1R121204	Kenworth	1R121204	—	—	MAF9375
FLTA1R12303	Freightliner, Rear	1R12303	FSIW013589780	—	MAF9780
FLTA1R12367	Hendrickson	1R12367	FSIW013589640	—	MAF9640
FLTA1R12375	Hendrickson Trailer	1R12375	FSIW013589265	—	MAF9265
FLTA1R12403	Hendrickson Truck	1R12403	FSIW013589373	—	MAF9373
FLTA1R12432	Hendrickson Truck	1R12432	FSIW013581191	—	MAF1191
FLTA1R12508	SAF Holland	1R12508	FSIW013588204	—	MAF8204
FLTA1R12523	Airspring	1R12523	FSIW013589876	—	—
FLTA1R12538	International, Rear	1R12538	FSIW013589648	—	MAF9648
FLTA1R12568	Peterbilt, Low Air	1R12568	FSIW013588852	—	MAF8852
FLTA1R12603	Freightliner	1R12603	FSIW013589781	—	MAF9781
FLTA1R12615	Volvo, Rear	1R12615	FSIW013588829	—	MAF8829
FLTA1R12689	Airspring	1R12689	FSIW013581192	—	—
FLTA1R13119	Hendrickson	1R13077	FSIW031589270	S20010	—
FLTA1R13124	Hendrickson	1R13124	FSIW013588755	—	MAF8755
FLTA1R13130	Meritor	1R13130	FSIW013588729	—	MAF8729
FLTA1R13176	Hendrickson	1R13176	FSIW013588713	—	MAF8713
FLTA1R14039	Hendrickson, Auxiliary	1R14039	FSIW013588050	—	MAF8050
FLTA1R14171	Hendrickson	1R14171	FSIW013588091	—	MAF8091
FLTA1R9978	Hendrickson	1R9978	—	—	MAF9978
FLTA1S5175	Freightliner	1S5175	FSIW023587205, 7207, 7215	—	MAF7215
FLTA1S5176	Freightliner	1S5176	FSIW023587202, 7206	—	MAF7206
FLTA1S5186	Peterbilt	1S5186	FSIW023587036	—	MAF7036
FSIW013589541	Kenworth	1R11268	—	—	MAF9541
FSIW013589978	Hendrickson	1R11221	—	S28929	MAF9622
FSIW013589622	Kenworth	1R11-211	—	—	—



Trailer air springs are in Section 15 — Trailer Parts

OTHER SUSPENSION COMPONENTS

PN	DESCRIPTION	APPLICATION	OE PART X-REF	DAYTON X-REF	AUTOMANN X-REF
R304685	Load Spring #20, 9-1/2" Diameter	Chalmers 800	15002	325-156	MLC11
R307774	Hardware Kit, Type 2 Joints	Chalmers 800	K880460	334-770	BKC580500GR8
R3014807	Tie-Bar Bolster Spring Service Kit, includes Wear Plate	Hendrickson Haulmaax	64179-048	334-1845	MLC5
R3016356	Bolster Spring without Tie-Bar Service Kit, includes Wear Plate	Hendrickson Haulmaax	64179-049	334-1727	MHS448K4
R3014896	Progressive Load Spring for Vehicles Built After 07/15/2014	Hendrickson Haulmaax	67778-000	—	MHS58948
R3016357	Progressive Load Spring Service Kit for Vehicles Built After 07/15/2014, includes Hardware	Hendrickson Haulmaax	60961-747	334-2031	—
R3015155	Auxiliary Spring Shim, 0.25"	Hendrickson Haulmaax	60791-000	334-1728	A109
R3014673A	Quik-Align® Collar Service Kit, Not for Pierce Vehicles, One Wheel End	Hendrickson Primaax EX	60632-019	334-1699	—
R303916	Trunnion Rebuild Kit, includes Key No. 2, 3, 4, 5, 17, 18 Axle Set	Mack Camelback	—	334-580	MTA505
R302919	Upper Insulator Pad, Rubber, 6" Long x 4-1/2" Wide x 3" Thick, 1-3/4" Diameter Pin	Mack Camelback	10QK370	325-113	ABP4
R308667	Upper Insulator Pad, Poly, 6" Long x 4-1/2" Wide x 3" Thick, 1-3/4" Diameter Pin	Mack Camelback	—	325-113U	—
R302920	Lower Insulator Pad, Rubber, 6" Long x 6" Wide x 3-3/4" Thick, 1-3/4" Diameter Pin	Mack Camelback	10QK36B	325-110	ABP2
R307480	Lower Insulator Pad, Poly, 6" Long x 6" Wide x 3-3/4" Thick, 1-3/4" Diameter Pin	Mack Camelback	—	325-127	—
R3016779	Wear Pad Kit 2007 - Current	Mack and Volvo Corporate Air	20703083	—	—
R307862	Wear Pad Kit, 1/2" Bolts, use with G-16711 Hanger	Peterbilt Air Trac	23-12566	—	MPB70
R309300A	Pivot Connection Kit, includes Bushing and Hardware, AD123 and AD126 Only	SAF Holland/Neway AD Series	48100260, SRK-200	339-233	MSRK646
R3015340	Connection Kit, Axle, Bar Pin Style, includes Hardware and Bushing, AD123 Only	SAF Holland/Neway AD Series	48100315, SRK-452	339-270	MSRK1150
R3016638	Connection Kit, Axle, Bar Pin, includes Hardware and Bushing, AD126 Only	SAF Holland/Neway AD Series	48100313, SRK-450	—	MSRK1146
R3010730A	Pivot Bolt Kit, Quik-Align®, 10-1/2" Long Bolt, All Models Except AANL and AANLS	Hendrickson INTRAAX®/VANTRAAX®	S-24679	334-1579	MHS203
R3014635	Pivot Bolt Kit, Quik-Align®, 7" Long Bolt, AANL and AANLS Models	Hendrickson INTRAAX®/VANTRAAX®	S-24705	334-1637	MHS205
R309575	Rebush Tool, Wide Bushing, All Models Except AANL and AANLS	Hendrickson INTRAAX®/VANTRAAX®	S-21307	334-936	TRB5912-T

SUSPENSION (CONT'D)



OTHER SUSPENSION COMPONENTS (CONT'D)					
PN	DESCRIPTION	APPLICATION	OE PART X-REF	DAYTON X-REF	AUTOMANN X-REF
R3014634	Rebush Tool, Narrow Bushing, AANL and AANLS Models	Hendrickson INTRAAX®/VANTRAAX®	S-24736	334-1655	—
R307532	Equalizer, Fabricated, Rubber Bushing, 1-Bolt, 42-1/2" and 49" Axle Spacing	Hutch H7700-H9700	16158-01	338-886	EQ019
R309471	Equalizer, Cast, Rubber Bushing, 1-Bolt, 42-1/2" and 49" Axle Spacing	Hutch H7700-H9700	17784-01	338-887	EQ028
R302781A	Equalizer, Fabricated, Rubber Bushing, OE Equivalent, 2-Bolt, 42-1/2" and 49" Axle Spacing	Hutch H7700-H9700	750-03	338-419S	EQ013
R302889	Equalizer, Cast, Rubber Bushing, 2-Bolt, 42-1/2" and 49" Axle Spacing	Hutch H7700-H9700	19137-01	338-408	EQ014
R309472	Equalizer Bushing, Rubber and Bolt Kit, 1-Bolt	Hutch H7700-H9700	—	334-1272	TRK5542
R302003	Equalizer Bushing, Rubber and Bolt Kit, 2-Bolt	Hutch H7700-H9700	—	334-341	TRK5541
R302907A	U-Bolt Top Plate	Hutch H7700-H9700	16868-01	338-381	M852
R302842	Delrin Spring Liner Pad	Hutch H7700-H9700	—	GL-295	—
R3016520	Galvanized Steel Spring Liner Pad	Hutch H7700-H9700	7052-02	—	—
R309487	Replacement Hanger Wear Pad	Hutch H7700-H9700	755-03	334-1827	M8301
R302909	U-Bolts Bottom Plate, 5" Round, Axle, 7/8" Diameter	Hutch H7700-H9700	710-00	338-415	M8286
R309839	Torque Arm Bolt and Flange Nut	Hutch H7700-H9700	—	334-345	—
R304835	Rebound Bolt Kit, 5/8", 18" x 4-1/2" Long, includes Bolt, Spacer and Nut	Hutch H7700-H9700	10287-00	334-343	SRL01
KIT11350	Pivot Bolt And Bushing Kit, MTA23T Only, includes Bushing, Alignment Collars and Hardware	Meritor MTA	—	—	—
KIT11351	Pivot Bolt And Bushing Kit, All MTA25 and 30 Models, includes Bushing, Alignment Collars and Hardware	Meritor MTA	—	—	—
KIT11300	Control Arm Bushing and Bolt Kit, includes Bushing and Hardware	Meritor RHP-MPA	—	334-1670	TRK11101
KIT11305	Control Arm Assembly, includes Control Arm, Bushing and Hardware	Meritor RHP-MPA	—	—	MA6345
R303283A	Adjustable Torque Arm without Bushings, Rear 42" – 44" Axle Spacing, Front 49" – 109" Axle Spacing	Reyco 21B Cast	15172-01	345-199	TR001
R302846A	Adi Equalizer without Bushing, 49" Axle Spacing	Reyco 21B Cast	21725-01	338-199	EQ001
R3010768A	Adi Equalizer without Bushing, 42" – 49" Axle Spacing	Reyco 21B Cast	25222-01	—	EQ001S
R309561	Hanger Weld-On Wear Plate, Front and Rear	Reyco 21B Cast	15630-01	334-903	M850
R3016552	Connection Kit, Pivot	SAF Holland CBX 23/25	48100394/SRK-530	334-1962	TRK1306
R3016553	Swing Align Kit	SAF Holland CBX 23/25	48100406/SRK-542	334-1960	MSRK1330
R309305	Equalizer with E-4827 Bushing	SAF Holland/Binkley Duralite™	SP0131	338-1306	EQ042
R309309	Equalizer Bolt and Nut Assembly	SAF Holland/Binkley Duralite™	—	327-500	BKF100600GR5
R3016630	Spring Seat, 2-3/4" High	SAF Holland/Binkley Duralite™	SP0149-05	338-1807	—

HEIGHT CONTROL AND LEVELING



HEIGHT CONTROL								
PN	DESCRIPTION	APPLICATION	HADLEY X-REF	DAYTON AIR X-REF	AUTOMANN X-REF	PACCAR X-REF	HALDEX X-REF	BLUE BIRD X-REF
R3014729	Height Control Valve, Universal, No Dump, Hadley® Next Gen Series	Various, Universal Trailer	H01500UN	—	171.H01500UNOE	—	—	4317236
R3014730	Height Control Valve, Universal, Remove Air to Dump	Various, Universal Trailer	H01502UNC	—	171.6310BFAB13	—	—	14860
R3014732	Height Control Valve, Universal, Hadley® Next Gen, 1/4" Ports, Apply Air to Dump	Kenworth and Peterbilt	H01501PUD	—	—	—	—	—
R3014731	Universal Height Control Valve, Hadley® Next Gen, Apply Air to Dump	Various, Universal	H01501UD	—	171.H01501UDOE	HV9990, 08-3315, 08-02932, HV54007, 08-02947	KN27000, 90555375, 90554950	—
R309625	Universal Linkage Kit	Various, Universal	HPD450-3	—	—	—	—	—
2591915C1	Valve, I-8 Control	ProStar®, LoneStar®, Severe Service	—	—	—	—	—	—
2507757C1	Valve Height Control	International Severe Service, 9100-9400 and 9900	—	—	—	—	—	—
SAF50860014	HCV Kit, Pressure Dump	Volvo	H01501UD	K865002	—	—	—	—
HAD450CE	Alve Leveling, HT, Control Air Suspend	PACCAR	450CE	—	—	03-06212	—	—

LEVELING								
PN	DESCRIPTION	APPLICATION	HADLEY X-REF	DAYTON AIR X-REF	AUTOMANN X-REF	PACCAR X-REF	HALDEX X-REF	BLUE BIRD X-REF
HAD450CE	Alve Leveling, HT, Control Air Suspend	PACCAR	450CE	—	—	03-06212	—	—

SHOCK ABSORBERS

Gabriel HD
THE ORIGINAL

MONROE

SHOCKS

PN	DESCRIPTION	APPLICATION	GABRIEL X-REF	MONROE X-REF	SACHS X-REF
GAB85724	FleetLine Heavy-Duty Shock, 85000 Series	Freightliner, Sterling, Thomas School Bus, Western Star, Rear	—	65490	315395, 510018
GAB85058	FleetLine Heavy-Duty Shock, 85000 Series	Blue Bird School Bus, Freightliner, International, Thomas School Bus, Front	—	65109	315398
GAB83038	FleetLine Heavy-Duty Shock, 83000 Series	Freightliner Cab	—	66122	315616
GAB85000	FleetLine Heavy-Duty Shock, 85000 Series	Great Dane Trailer, Hendrickson Trailer, Kenworth and Peterbilt, Ridewell Corporation, SAF Holland, Stoughton Trailers Inc., Thomas School Bus, Trailmobile Canada Corp., Utility Trailer Manufacturing Company, Wabash National, Watson & Chalin, Rear	—	65416	410056
GAB85003	FleetLine Heavy-Duty Shock, 85000 Series	IC Corporation, International, Rear	—	65409	315416
GAB85958	FleetLine Heavy-Duty Shock, 85000 Series	Freightliner, Western Star, Front	—	65148	410026
GAB83456	FleetLine Heavy-Duty Shock, 83000 Series	IC Corporation, International, Mitsubishi-Fuso, Front	—	66923	315418
GAB85088	FleetLine Heavy-Duty Shock, 85000 Series	Mack and Volvo, Rear	—	66431, 65486	315421
GAB83001	FleetLine Heavy-Duty Shock, 83000 Series	Freightliner Cab	—	66118	315555
GAB85963	FleetLine Heavy-Duty Shock, 85000 Series	International, Front	—	65499	—
GAB85959	FleetLine Heavy-Duty Shock, 85000 Series	Blue Bird School Bus, Freightliner, Hendrickson Truck, Kenworth and Peterbilt, Spartan Motors, Sterling, Front	—	65162	315414
GAB85918	FleetLine Heavy-Duty Shock, 85000 Series	Freightliner, Sterling, Thomas School Bus, Western Star, Front	—	65139	311229
GAB85098	FleetLine Heavy-Duty Shock, 85000 Series	Mack and Volvo, Front	—	65494	315607
GAB85931	FleetLine Heavy-Duty Shock, 85000 Series	International, Rear	—	65492	315417
GAB85066	FleetLine Heavy-Duty Shock, 85000 Series	Mack and Volvo, Rear	—	65486	315609
GAB85052	FleetLine Heavy-Duty Shock, 85000 Series	Blue Bird School Bus, Great Dane Trailer, Hendrickson Trailer, Reyco Suspension, SAF Holland, Tuthill Technologies, Wabash National, Watson & Chalin, Rear	—	65510	315541
GAB83163	FleetLine Heavy-Duty Shock, 83000 Series	IC Corporation, International, Front	—	65143	316302
GAB85923	FleetLine Heavy-Duty Shock, 85000 Series	International, Rear	—	65492	315417
GAB83128	FleetLine Heavy-Duty Shock, 83000 Series	Hendrickson Trailer, Reyco Suspension, SAF Holland, Stoughton Trailers Inc., Wabash National, Rear	—	66608, 65419	315411
GAB85924	FleetLine Heavy-Duty Shock, 85000 Series	International, Front	—	65147	315547
M85724	Shock Absorber	Heavy-Duty Shock Absorber	85724	65490	—
M85000	Shock Absorber	Heavy-Duty Shock Absorber	57639	65419	—
M85066	Shock Absorber	Heavy-Duty Shock Absorber	85066	65486	—
M85323	Shock Absorber	Heavy-Duty Shock Absorber	85323	65416	—
M646155	Steering Stabilizer	Steering Stabilizer	646155	—	—
M85918	Shock Absorber	Heavy-Duty Shock Absorber	85918	65139	—
M83128	Shock Absorber	Heavy-Duty Shock Absorber	83128	6608	—
M85061	Shock Absorber	Heavy-Duty Shock Absorber	85061	65130	—
M83038	Shock Absorber	Heavy-Duty Shock Absorber	83038	66122	—
M85919	Shock Absorber	Heavy-Duty Shock Absorber	671907	65503	—
M85069	Shock Absorber	Heavy-Duty Shock Absorber	85069	65468	—
M85320	Shock Absorber	Heavy-Duty Shock Absorber	85320	65103	—
M85045	Shock Absorber	Heavy-Duty Shock Absorber	85045	66627	—
M85070	Shock Absorber	Heavy-Duty Shock Absorber	85070	65159	—
M85052	Shock Absorber	Heavy-Duty Shock Absorber	85052	65510	—
M83009	Shock Absorber	Heavy-Duty Shock Absorber	83009	66147	—
M85062	Shock Absorber	Heavy-Duty Shock Absorber	85062	65101	—
M83001	Shock Absorber	Heavy-Duty Shock Absorber	83001	66118	—
M85311	Shock Absorber	Heavy-Duty Shock Absorber	680586	65402	—
M85067	Shock Absorber	Heavy-Duty Shock Absorber	85067	65495	—
M85005	Shock Absorber	Heavy-Duty Shock Absorber	728617	65110	—
M85934	Shock Absorber	Heavy-Duty Shock Absorber	85934	65493	—
M85729	Shock Absorber	Heavy-Duty Shock Absorber	85729	74440	—
M83147	Shock Absorber	Heavy-Duty Shock Absorber	83147	65505	—
M85072	Shock Absorber	Heavy-Duty Shock Absorber	85072	65504	—
M85047	Shock Absorber	Heavy-Duty Shock Absorber	85047	65466	—

Gabriel HD
THE ORIGINAL

Misting vs. Leaking Shock Absorbers

A misting shock has a light mist of oil or grimy film on the outside of the shock body. This is considered normal as the mist is generated from a working shock. However, a leaking shock that shows streaks of fluid down the shock body means that something is wrong and they need to be replaced. Remember this saying: If it's STREAKING, it's LEAKING.

Answergarage.com/MistingVsLeaking



Gabriel[®] HD

THE ORIGINAL

**RUN LONGER.
RUN STRONGER.**



***Gabriel[®] Heavy Duty Shock Absorbers
are built to keep your fleet on the road longer!***



**Anti-Corrosion End
Mounts** for more uptime

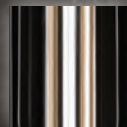

Chromed Piston Rod
withstands the harshest
conditions, to extend shock life



**Superior Anti-Fade
Performance** improves
control & maximizes tire life

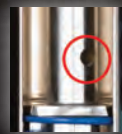

**Best-in-Class Hydraulic
Stop** prevents damage to
shocks & air springs

Scan to see why
FLEETLINE[®]
is the superior choice!

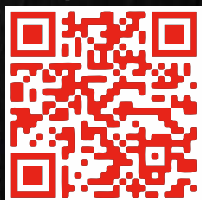

FleetLine[®] Key
Advantages Video

**NEW DEALER DIRECT SHIP
PROGRAM AVAILABLE!**

Gabriel.com

Gabriel[®] Training, Videos,
Tech Bulletins & more at
AnswerGarage.com

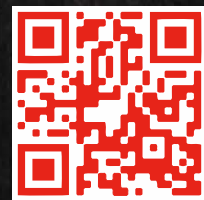

Questions?
Call our tech service line
(800) 999-3903



ALL THE SUPPLIES YOU NEED.

We've got you covered in the supplies.
Order online at RepairLinkShop.com

PARTS FIT TO PERFORM

fleetrite.com

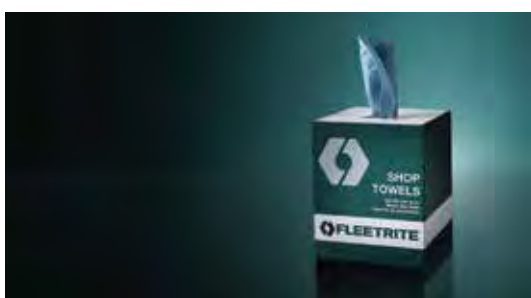

MULTI-PURPOSE SHOP TOWELS

These aftermarket multi-purpose shop towels from Fleetrite® are super absorbent, which make them great for wiping off grease and stains, and for everyday cleanup.

Order online at RepairLinkShop.com

PARTS FIT TO PERFORM

fleetrite.com



TOOLS AND EQUIPMENT



GLOVES – PROTECT YOUR HANDS (GLOVES, ETC)

PN	DESCRIPTION	APPLICATION
FLTBN6M	Fleetrite Industrial Nitrile, 100 Count, M	Disposable Nitrile Gloves
FLTBN6L	Fleetrite Industrial Nitrile, 100 Count, L	Disposable Nitrile Gloves
FLTBN6XL	Fleetrite Industrial Nitrile, 100 Count, XL	Disposable Nitrile Gloves
FLTBN6XXL	Fleetrite Industrial Nitrile, 100 Count, XXL	Disposable Nitrile Gloves
VEN6045N	Venom Steel 2-Layer Rip Resistant Nitrile, 50 Count, OSFM	Disposable 2-Layer Nitrile Gloves
VEN6085	Venom Steel Maximum Grip Nitrile, 50 Count, OSFM	Disposable Nitrile Gloves
PVP1132L	Wells Lamont Cowhide, Adjustable Ball Wrist, L	Work Gloves
PVP1171L	Wells Lamont Leather, Elastic Wrist, L	Work Gloves
PVP12TLF	Wells Lamont Heavy-Duty, Leather Palm, 3 Pack, L	Work Gloves
PVP3214L	Wells Lamont Leather Palm Stretch Fit Back, L	Work Gloves
PVP4000L	Wells Lamont Heavy-Duty Cowhide Palm, L	Work Gloves
PVP508LF	Wells Lamont Jersey Knit, 3 Pack, L	Work Gloves
PVP555L	Wells Lamont Cold Weather Latex Coat, L	Work Gloves
PVP589L	Wells Lamont Nitrile Coat Knuckle Protect, L	Work Gloves
PVP7850L	Wells Lamont FX3 Synthetic Leather Palm, Hi-Dexterity, L	Work Gloves

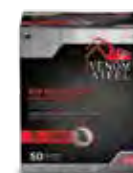

SPILLS, TOWELS AND CLEAN UP

PN	DESCRIPTION	APPLICATION
FLTSISPMED1	Sorbent Pads, 15" x 18" Medium Absorbency, 100 Pack	Spill Absorbant
FLTSISRHEV2	Sorbent Roll, Heavy Absorbency, 30" x 150', 1 Roll	Spill Absorbant
FLTSIQKD30	Quick Dry Granular, 30 Lb. Bag	Spill Absorbant
FLTSISPDISI	Wall Mounted Soap Dispenser	Janitorial
FLTSIORGREF1	Heavy-Duty Industrial Orange Scrub Hand Cleaner Refill	Janitorial
FLTSICLNR2	Heavy-Duty Waterless Skin Cleanser, 8 Oz., Tube	Janitorial
FLTSTB200	Shop Towels Box, 200 Count, 10" x 12", 6 Case	Janitorial
FLTSTR60	Shop Towels Small Roll, 55 Count, 11" x 9.4", 30 Case	Janitorial
VENWP60	Venom Steel Workshop Wipes, 60 Count, 8" x 12"	Big, Tough Wipes



VISIBILITY AND MISC

PN	DESCRIPTION	APPLICATION
FLTSICN28	28" Traffic Cone with Reflective Stripes	Traffic Safety
FLTSICN42	42" Looper Tube Orange Post with Collars, 12 Lb. Rubber Base	Traffic Safety
FLTSIWC1	Heavy-Duty Wheel Chock with Eye Bolt, 10" x 8" x 6"	Vehicle Safety
FLTSIHHAT1	Hardhat	Head Protection
FLTSIEARNC2	Non-Corded Earplugs	Hearing Protection
FLTSIVESTLG	Safety Vest, L	Protective Clothing
FLTSIVESTXL	Safety Vest, XL	Protective Clothing
FLTSIVESTXXL	Safety Vest, XXL	Protective Clothing
FLTSISFGLS1	Safety Glasses, Fleetrite Logo	Eye Protection
FLTSIOTSSFGLS2	Over-the-Spectacle Safety Glasses	Eye Protection
FLTSISFGOG3	Safety Goggles	Eye Protection
FLTSIHHATAD2	Hardhat Adaptor	Head/Face Protection
FLTSISHLD1	Face Shield	Head/Face Protection
PVPUIP10655	Little Trees® Xtra Black Ice®	Cabin Air Fresheners
PVPUIP10601	Little Trees® Xtra Royal Pine	Cabin Air Fresheners
PVPU2S22055	Little Trees® Mini Black Ice®, 2 Pack	Cabin Air Fresheners
PVPU2S22089	Little Trees® Mini New Car Scent, 2 Pack	Cabin Air Fresheners
PVPU2S22005	Little Trees® Mini Vanilla Aroma, 2 Pack	Cabin Air Fresheners
PVP41333037615	Duracell® AA Batteries, 8 Pack	Batteries
PVP41333929484	Duracell® AA Batteries, 16 Pack	Batteries
PVP41333042619	Duracell® AAA Batteries, 8 Pack	Batteries
PVP10041333038312	Duracell® AAA Batteries, 16 Pack	Batteries
PVP41333091617	Duracell® C Batteries, 2 Pack	Batteries
PVP41333090610	Duracell® D Batteries, 2 Pack	Batteries
PVP41333093611	Duracell® 9V Batteries, 1 Pack	Batteries





PULLING THE LOAD.

Designed to increase durability, which is key to keeping your vehicle on the road.
Order online at RepairLinkShop.com

PARTS FIT TO PERFORM

fleetrite.com



FLEETRITE® TIRE CHAINS.

Designed for on-highway applications. These products are manufactured with high quality carbon steel and tested to meet all industry specifications.

PARTS FIT TO PERFORM

fleetrite.com

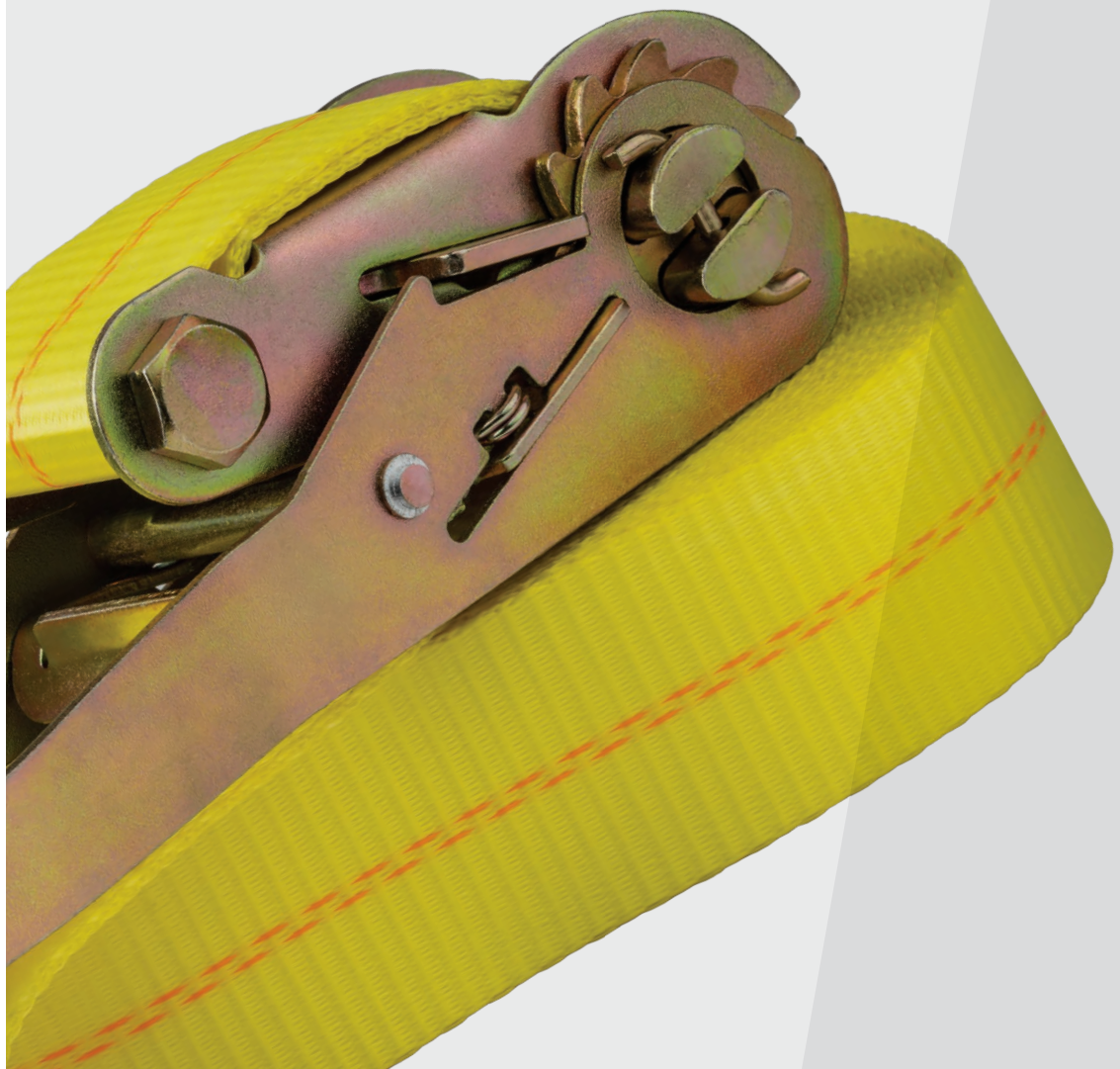

SUSPENSION



TRAILER SPRINGS

PN	DESCRIPTION	APPLICATION	OE X-REF	DAYTON X-REF
TRA021	Spring, 1 Leaf	Hutch H/CH 7600, 7700, 9600 and 9700 Series; Reyco 86, 88 Model TRA021 A	363-00, 17902	TRA-021
TRA2260	Spring, 8 Leaf High Arch	Heavy-Duty Hutch H/CH 7600, 7700, 9600 and 9700 Series	752-05	TRA-2260
H81235000S	Spring, 3 Leaf Low Arch	Hutch H/CH 7600, 7700, 9600 and 9700 Series	356-00	TRA-2728
TRA2740	Spring, 3 Leaf High Arch	Heavy-Duty Hutch H/CH 7600, 7700, 9600 and 9700 Series	365-00	TRA-274

TRAILER AIR SPRINGS

PN	APPLICATION	GOODYEAR X-REF	FLEETRITE X-REF	FIRESTONE X-REF	HENDRICKSON X-REF	CONTITECH X-REF
FLTA1R13038	Hendrickson Trailer	1R13038	—	FSIW013589122	—	—
FLTA1R13118	Hendrickson Trailer	1R13118	—	FSIW013589580	—	—
FLTA1R13119	Hendrickson Trailer	1R13119	—	FSIW013589270	—	—
FLTA1R13159	Hendrickson Trailer	1R13159	—	FSIW013588709	—	—
FLTA1R13177	Hendrickson Trailer	1R13177	—	FSIW013588708	—	—
MAF8709	Trailer Air Spring	1R13159	—	FS8709	—	1010515P460
MAF9978	Trailer Air Spring	—	—	FS9978	—	91014P959
MAF8091	Trailer Air Spring	1R14171	—	FS8091	—	11105A16P523
MAF9122	Trailer Air Spring	1R13038	—	FS9122	—	1110521A313
MAF8050	Trailer Air Spring	1R14039	—	FS8050	—	11105C16A320
MAF9265	Trailer Air Spring	1R12375	—	FS9265	—	91019P435
MAF9270	Trailer Air Spring	1R12225	—	FS9270	—	910135S433
MAF8708	Trailer Air Spring	1R13128	—	FS8708	—	101016S526
MAF9974	Trailer Air Spring	1R121048	—	FS9974	—	910175A930
MAF9580	Trailer Air Spring	1R13118	—	FS9580	—	101021P434
MAF6897	Trailer Air Spring	2B09229	—	FS6897	—	FD20019505
MAF8033	Trailer Air Spring	3B12312	—	FS8033	—	FT33029525
MAF8774	Trailer Air Spring	1R14172	—	FS8774	—	11105F17P745
MAF9626	Trailer Air Spring	—	—	FS9626	—	910S16P1068(BK)
MAF8713	Trailer Air Spring	1R13176	—	FS8713	—	101016S533
FSIW013588709	Hendrickson Trailer S21800 (INTRAAX® AA230) 1997 - Current	1R13159	FLTA1R13159	—	S21800	—
FSIW013588050	Hendrickson Trailer S4771; Hendrickson Canada B-12514-013; Tuthill-Reyco 23631-01; Watson & Chalin AS-0039 Supersedes AT 19J-6	1R14039	FLTA1R14039	—	S4771	—
FSIW013588091	Hendrickson Trailer S20901 (INTRAAX® 250) - Reuse Metal Disk, Hendrickson Trailer S21784 with Metal Disk for Piston Support	1R14171	FLTA1R14171	—	S20901	—
FSIW013589265	Hendrickson Trailer S20124, Hendrickson Trailer HT-250T, Hendrickson Trailer C20413 (Rotate Piston to 45 Degree Alignment), Hendrickson Trailer HT-250U (All Others, Special Mounting), 90557037, 90557054, 90557075, Reyco 12882-01	1R12375	FLTA1R12375	—	—	—
FSIW013589580	Hendrickson Trailer S20127 (HT-250U9-006, HT-250UY9Y-006), Replaces 1T15VLT-10.5, 1T15V-11, W01-358-9262	1R13118	FLTA1R13118	—	—	—
FSIW013588708	Hendrickson Trailer S21966 (HKA200 Special)	1R13128	FLTA1R13177	—	—	—
FSIW013588713	Hendrickson Trailer S22948 (VANTRAAX®) Prior to 1999, Used 9525 Piston with Bumper Spacer	1R13140	FLTA1R13176	—	22948	—
FSIW013589122	Hendrickson Trailer S3467, S3830; Holland (Neway) 90557020, 90557071, 90557076, 90557077; Hendrickson Canada B-12514-008, B-12514-010; Porcupine Reyco 12883-02; Sauer P50-732; Ridewell 1003589122C; Temisko; Watson & Chalin AS-0023; Holland (Neway) 90557185 (Parallel Align)	1R13038	FLTA1R13038	—	S3467, S3830	—
FSIW013587897	Hendrickson Auxiliary 002878 (Lift Bag); Hendrickson Auxiliary (Pararev); Hendrickson Trailer S23114	2B9495	—	—	—	—
FSIW013588774	Hendrickson Trailer S25873 Replacement Piston, without Mounting Plate; Watson & Chalin AS-0159	1R14172	—	—	—	—



SUSPENSION (CONT'D)

HENDRICKSON
 Genuine Parts

MERITOR

TRAILER AXLE ASSEMBLIES

PN	DESCRIPTION	CAPACITY	SPINDLE X-REF	TRACK LENGTH X-REF	BRAKE X-REF	CAM LENGTH X-REF
TN3761DH8228	Dressed Axle	22,500 Lbs.	TN Taper	71.5"	Air Disc Brake	—
TN3761DH8229	Dressed Axle	22,500 Lbs.	TN Taper	77.5"	Air Disc Brake	—
TP8671LH8623	Dressed Axle	22,500 Lbs.	TQ Parallel	77.5"	Cam Brake	Long
TP8671LH8773	Dressed Axle	22,500 Lbs.	TQ Parallel	71.5"	Cam Brake	Long
TQ3761DH9098	Dressed Axle	22,500 Lbs.	TQ Taper	71.5"	Air Disc Brake	—
TQ3761DH9100	Dressed Axle	22,500 Lbs.	TQ Taper	77.5"	Air Disc Brake	—
TQ4671LH8693	Dressed Axle	22,500 Lbs.	TQ Taper	77.5"	Cam Brake	Long
TQ4671LH8777	Dressed Axle	22,500 Lbs.	TQ Taper	71.5"	Cam Brake	Long
TN4671L4594	Beam and Brake	22,500 Lbs.	TN Taper	71.5"	—	—
TN4671L8339	Beam and Brake	22,500 Lbs.	TN Taper	77.5"	—	—
TP8671L7757	Beam and Brake	25,000 Lbs.	TP Taper	71.5"	—	—
TP8671L4628	Beam and Brake	25,000 Lbs.	TP Taper	77.5"	—	—
TQ4681L9256	Beam and Brake	25,000 Lbs.	TQ Taper	71.5"	—	—
TQ4671L7969	Beam and Brake	25,000 Lbs.	TQ Taper	77.5"	—	—



MERITOR TRAILING ARM SUSPENSION

PN	DESCRIPTION	CAPACITY	SPINDLE X-REF	TRACK LENGTH X-REF	BRAKE X-REF
MTA23T000TN1832	Dressed Axle	23,000 Lbs.	TN Taper	77.5"	Air Disc Brake
MTA23T000TN1868	Dressed Axle	23,000 Lbs.	TN Taper	71.5"	Air Disc Brake
MTA23T000TP1833	Dressed Axle	23,000 Lbs.	TP Parallel	71.5"	Cam Brake
MTA23T000TP1834	Dressed Axle	23,000 Lbs.	TP Parallel	77.5"	Cam Brake
MTA25T000TQ1835	Dressed Axle	23,000 Lbs.	TQ Taper	71.5"	Cam Brake
MTA25T000TQ1836	Dressed Axle	23,000 Lbs.	TQ Taper	77.5"	Cam Brake
MTA25T000TQ1839	Dressed Axle	23,000 Lbs.	TQ Taper	77.5"	Air Disc Brake
MTA25T000TQ1936	Dressed Axle	23,000 Lbs.	TQ Taper	71.5"	Air Disc Brake
MTA23T000TN1591	Beam and Brake	22,500 Lbs.	TN Taper	71.5"	—
MTA23T000TN1582	Beam and Brake	22,500 Lbs.	TN Taper	77.5"	—



LANDING GEAR

FLEET ENGINEERS
 A DIVISION OF TRAMEC SLOAN

LANDING GEAR AND ACCESSORIES

PN	DESCRIPTION	APPLICATION	COMMON X-REF
ZFA01300991	Adjust-a-Brace, 2-Piece, Heavy-Duty, 26" - 41"	Landing Gear Brace	04-40-26-41, 1613
ZFA01300427	Crank Horizontal Folding, 11.5" x 13.5"	Landing Gear Crank	03-207-H, LG0083 04, 1296
ZFA01300073	Low Mount Style Sand Shoes, 10" x 10"	Landing Gear Sand Shoe	1295, 05-310
ZFA01300232	Axle Welded Cap with Hardware Set, 8.5"	Landing Gear Axle	06-410
ZFA01300437	Vertical Folding Crank, 11.50" Long, 13.50" Throw	Landing Gear Crank	03-211-V, LG0083 03, 1365
ZFA01301192	Sand Shoe, 10" x 10", Roadkote Finish	Landing Gear Sand Shoe	05-300, 1291
ZFA01300439	Vertical Folding Crank, 16.25" Length, 13.50" Throw	Landing Gear Crank	03-215-V, 1366
ZFA01300436	Vertical Folding Crank, 7.50" Length, 13.50" Throw	Landing Gear Crank	03-207-V, LG0083.01, 1664
ZFA01300430	Horizontal Folding Crank, 20" Length, 13.50" Throw	Landing Gear Crank	03-221-H, LG0083.06, 1298
ZFA01300426	Horizontal Folding Crank, 7.50" Length, 13.50" Throw	Landing Gear Crank	03-207-H, LG0083.02, 1695
ZFA01301196	Standard Design Sand Shoe, 10" x 10"	Landing Gear Sand Shoe	05-300, 1291

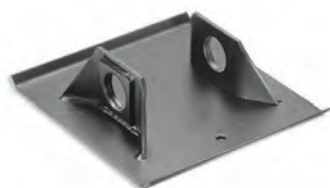

TRAILER



DOOR

PN	DESCRIPTION	APPLICATION	WHITING X-REF	TODCO X-REF	COMMON X-REF
ZFA02510102	Roller 2" Steel	Roll-up Door Roller	—	70224	—
ZFA025E10002	Hinge 2" Roller End Assembly	Roll-up Door Hinge	2996	70162	—
ZFA02510100	Roller 1" Steel	Roll-up Door Roller	1209	61174, 69162	—
ZFA02510101	Roller 2" Nylon	Roll-up Door Roller	4026, 40247, 291000	61424, 70225	—
ZFA02100051	Hold-Back Chain and Snap Set Chain, Snap Assembly, Anchor	Swing Door Hold-Back	3228	—	—
ZFA02510001	Hinge 1" Roller End	Roll-up Door Hinge	—	—	—
ZFA025E10051	Hinge 2" Roller Flush Mount Center	Roll-up Door Hinge	—	—	—
ZFA02510050	Hinge 1" Roller PrecisionTrak Recessed Center	Roll-up Door Hinge	—	61196, 59126	—
ZFA02201182	Wabash Style 4-Hole Hinge	Door Hinge	—	—	WAB06301527, WAB06302245, 1089, P108940
ZFA02201081	Stoughton Style Aluminum 3-Hole Hinge	Door Hinge	—	—	04-86386-001-00, H-1086, P108630
ZFA02201407	Vanguard Style Aluminum 3-Hole Hinge	Door Hinge	—	—	RFP00127
ZFA02200407	Great Dane Style Aluminum 3-Hole Hinge	Door Hinge	—	—	31801018
ZFA02501434	110" Long Roll-Up Door Cables, Stainless Steel, 7" x 19", 1/4" Eyelet	Roll-up Door Cable	4020-1	—	—
ZFA02510402	15.50" Pull Strap Assemblies, Zinc Retainer and Zinc Rivets	Door Strap	257000	—	—
ZFA02200081	Fruehauf Style 2-Hole Hold Back	Door Hold-Back	—	—	586930, EBH6602-50
ZFA02510202	Top Fixture "Slide Only" for Recessed 1" Roller Door, Zinc Plated	Roll-up Door Fixture	4038, 210200	69431	—
ZFA02301657	Hyundai Style Aluminum 3-Hole Hinge	Door Hinge	—	—	TRR7000C-AH, 200003977
ZFA02501451	130" Long Roll-Up Door Cables, 7" x 19" Stainless Steel, 5/16" Eyelet, 79 Lbs.	Roll-up Door Cable	—	—	—
ZFA02201085	Utility Style Rubber Door Bumper	Door Bumper	—	—	3-1250-25
ZFA02510052	Stainless Steel Center Hinge for Flush Mount 2" Roller Doors	Roll-up Door Hinge	15-1	—	—

REFLECTORS AND CONSPICUITY

PN	DESCRIPTION
ZFA03304263	Universal Conspicuity Plates, Shortie
ZFA03304259	Universal Conspicuity Plates, Straight
ZFA99775004	DOT-C2 Reflective Tape, 150' Roll



Fleetrite® Trailer Air Hoses Undergo a 100% Inspection

Fleetrite trailer air hoses undergo a 100% inspection prior to leaving the plant. All hoses conform to ASTM and SAE standards/specifications. All air hoses are designed with thicker tube springs and wire for increased durability.

Fleetrite's 3-in-1 ABS System is an All-in-One Assembly

Fleetrite's 3-in-1 ABS System is an All-in-One Assembly: ABS cable, emergency hose, service hose. It includes factory-installed gladhands for major end user labor savings.

fleetrite.com



TRAILER (CONT'D)



OTHER TRAILER

PN	DESCRIPTION	APPLICATION	HUTCHENS X-REF	DAYTON X-REF	HENDRICKSON X-REF	REYCO X-REF	WATSON & CHALIN X-REF	COMMON CROSS X-REF
ZFA02403000	Vent Louvered Adjustable, 10.5" x 12.5"	—	—	—	—	—	—	—
ZFA98400035	Tire Carrier Spare, Standard Nash Style, Unassembled	—	—	—	—	—	—	—
ZFA98100166	Tire Carrier Adapter, Nash Style	—	—	—	—	—	—	—
ZFA02402501	Vent Door F1 Dry Freight, 17" x 11.38"	—	—	—	—	—	—	—
ZFA03300864	Shortie, Spring-Loaded Mud Flap Bracket, RoadKote	—	—	—	—	—	—	SF304SP-KIT
ZFA03400878	Shortie, Bar Type Mud Flap Bracket, Curbside, Extra Long	—	—	—	—	—	—	A87R
ZFA03400669	Shortie, Bar Type Mud Flap Bracket, Square Double Coil, Curbside	—	—	—	—	—	—	A84R
ZFA03400668	Shortie, Bar Type Mud Flap Bracket, Square Double Coil, Roadside	—	—	—	—	—	—	A84L
ZFA03304647	Shortie, Frame Mount, Spring-Loaded Brackets with Reflective Tape on Extended Flange Set, Roadkote	—	—	—	—	—	—	B67
ZFA03304648	Shortie, Stainless Steel Frame Mount, Spring-Loaded Mud Flap Bracket with Reflector Tape on Extended Flange Set	—	—	—	—	—	—	B67S
ATREQ5335158	Hutch Trailer Equalizer	H9700, H9600 4-Spring Trailer, 42-1/2", 49" Axle Spacing	16158-01	338-886U	—	—	—	—
ATREQ8335000	Reyco Trailer Equalizer	Model 86, 88, 89 4-Spring Trailer	—	338-378	—	0650-00	—	—
ATRTR5341500	Hutch Trailer Torque Rod	Multiple including H/CH 7700, 9700 4-Spring Trailer, Watson & Chalin SL Series	715-00	345-167	—	—	12954	—
ATRTR5345305	Hutch Trailer Torque Rod	Multiple including H/CH 7700, 9700 4-Spring Trailer, Watson & Chalin SL Series	713-05	345-164	—	—	17015	—
ATRTR8341520	Reyco Trailer Torque Rod	Multiple including 86, 88, 89 4-Spring Trailer, 86R	—	345-158	—	0075-20	—	—
ATRTR8345520	Reyco Trailer Torque Rod	Multiple including 86, 88, 89 4-Spring Trailer, 86R	—	345-157	—	1035-20	—	—
ATRPB5036001	Hendrickson INTRAAX® Bushing Kit	Hendrickson INTRAAX®/VANTRAAX®	—	334-1576	S-24691	—	17993-112	—
ATRPB5036914	Pivot Bushing Kit	Hendrickson HLM, HT, T, TDC, TMB Series	—	334-658	S-6914, A-6914	—	—	—
ATRPB0026839	Lift Axle Bushing Kit	Hendrickson, Watson & Chalin Lift Axles	—	—	R008839	—	SRL1190-1	—



ATRO's VIN-Less® Torque Rod Finder

ATRO has compiled a master database to simplify and expedite the process of finding replacement rods. Shorten the time at the counter and confirm the right part for your customer. Use the QR code to find your torque rod in three easy steps.

ATRObushing.com



Our parts keep working vehicles working

SKF best-in-class, competitively priced aftermarket replacement parts and services help truck, bus and trailer fleets cut downtime and total cost of ownership to boost uptime and drive profitability. Our TFO training program provides technicians with the tools and resources they need to maximize wheel-end reliability, while our premium-quality wheel-end parts help fleets **reduce maintenance, simplify repairs and keep vehicles on the road longer.**



Scan the QR code or visit vehicleaftermarket.skf.com to learn about the latest SKF innovative products and access the complete product range.

© SKF is a registered trademark of the SKF Group. | © SKF Group 2022.





FLEETRITE® CAMERA SYSTEMS.

Fleetrите camera systems provide critical tools to reduce false claims, protect assets, coach and exonerate drivers, and reduce safety related events for fleet owners.

Order online at RepairLinkShop.com

PARTS FIT TO PERFORM

fleetrите.com



FLEETRITE® BUS HEADLIGHTS.

Give your bus a fresh, new look while lowering your CSA points with Fleetrите headlights. Not only do our headlights look great, they make it super easy to replace cracked or hazed lighting assemblies and avoid CSA violations – and they're designed to fit many makes and models.

Order online at RepairLinkShop.com

PARTS FIT TO PERFORM

fleetrите.com





SEATING AND RESTRAINTS

SEAT BELTS AND RESTRAINTS

PN	DESCRIPTION
2236820C1	Seat Belt, Passenger or Driver, National, 3-Point Suspension, Adjuster D-Loop
2236822C1	Seat Belt, Passenger or Driver, National, 3-Point Suspension, Electrical, Black
Q8306L2	Restraint Strap Kit, Quarter Max Mounted for Left Track
2208845C1	Seat Belt, Driver, 3-Point Suspension
2236826C1	Seat Belt, Passenger or Driver, Seats Inc., 3-Point Suspension
SGF103181	Restraint Seat Belt, Special Needs Child, 25-65 Lbs.
2208846C2	Seat Belt, Driver, 3-Point Suspension
2236949C1	Seat Belt, Passenger or Driver, 3-Point Adjustable/Retractable
2517056C91	Kit, Belt 3-Point, Orange
2241014C1	Seat Belt, Passenger or Driver, 3-Point
3711358C93	Seat Belt Buckle with Tether
2236824C1	Seat Belt, Driver, 3-Point D-Loop, High Visibility Color
2220392C2	Seat Belt, Passenger Brown
SLFE201122	Oxygen Bottle Holder Assembly
3785576C1	Seat Belt, Passenger
3683878C5	39" Frame, Seat Back Rest, Weldment, Left/Right
3785574C1	Seat Belt, Passenger, Maroon, Standard
3785575C1	Seat Belt, Passenger
Q58522	Pouch, Storage Wall
3857682C91	Assembly Kit for Wheel Chair Seat Belt
SL8705	Web Cutter, Premium
Q10014	4 QRT-360 Retractors with L-Track Fittings, HR131 Retractable Lap and Shoulder Belt
Q8100A1TL	Deluxe Retractor Kit L-Track Fitting on Shoulder Belt
2511008C1	Seat Belt, Lap, BTI, Red
Q8107A1L	L-Tract
453702004	39" Seat Frame, High Back RH
Q57583A	Assembly Kit Scooter



SEATING AND FOAM

PN	DESCRIPTION
OBIC24510S	45" Seat High Back Foam, 2009 - Current
OBIC23910S	39" Seat Back, AMT, 2010 - Current
OBIC23994FAB	39" Seat High Back Fabric, IC Bus, 1994 - 2008
OBT23910S	39" Seat, Thomas, 2009 - Current
OBIC23994S	39" Seat High Back, AMT, NY BK, 1997 - Current
OBIC13994FAB	39" Seat Back, IC Bus, DOT, 1994 - 2009
OBIC839NYFAB	39" Seat, IC Bus, High Back, Barrier Fabric
OBIC13994S	39" Seat Low Back Foam, IC Bus, 1994 - 2008
ZB5736390060	39" Seat Cover, IC Bus, High Back, J-Hook, Prevail Blue
OBIC23910UCFAB	39" Seat High Back, IC Bus, Ucla Fab, 2009 - Current
2612195C92	39" Seat Back without Restraint, 42 Oz. Prevail Brown
ZB5736390082	39" Seat Cover, IC Bus, High Back, J-Hook, 42 Oz. Grey, 2010 - Current
ZB5736390101	39" Seat Cover, IC Bus, High Back, J-Hook, 42Oz. Green, 2010 - Current
ZBIM746390077Y3PT	39" Seat Back, IMMI Gen 5, J-Hook, 3-Point, Prevail Grey
OBBI139S	39" Seat Back Foam, DOT, BB
3771266C2	39" Seat Back Front Foam, Extra Thick
ZB5732390082	39" Seat Cover, IC Bus, Velcro, 42 Oz. Grey, 2010 - Current
ZB4720390037	39" Seat Cover, Thomas, High Back, Grey
ZB5736390109	38" Seat Back, Passenger, Upholstery
2612717C92	36"-39" Seat Back, 42 Oz. Vinyl, Lap Blue
2612721C92	36"-39" Seat Back, 42 Oz. Vinyl, N/R, Grey N/L
ZB3000340145	Pro Tech IV Padded Securement System, Prevail Black
2205285C2	Seat, National, Air Suspension, 42 Oz. Prevail Grey with Cloth
2518351C91	36" Seat Back, Gen 5 IC 2LG 12D YL YICS 2, 3-Point NTCD, Blue OEM
2612185C92	36" Seat Back, 3-Point, 42 Oz. Prevail Blue
2595317C92	Seat Cushion, High Back, Charcoal
2518346C91	36" Seat Back, Gen 5 IC 2LG 12D NL YICS 2, 3-Point, NTCD Grey Fabric



SAFETY EQUIPMENT



ROOF HATCHES AND HARDWARE

PN	DESCRIPTION
SMCT1975028111	SSV II with OSR, Arm 28" Mounting, White
SMC92450200	Roof Hatch
2230820C92	Roof Hatch, Emergency Exit
453712001	Roof Hatch, Pro-Low, No Vent, 92" Radius, White
SMCT197502812103	SSV II with OSR, Arm 28" Mounting, Right, White
SMC9319	Lid, Roof Emergency Escape Hatch
2237188C91	Roof Hatch Panel with Alarm and Starter Interlock
2598241C91	Roof Hatch Vent with Alarm
SMC92470200	Hatch, Pro-Low, No Vent, Front Engine
2221715C2	Roof Hatch, Emergency Exit, Keyed Lock



CROSSING ARMS

PN	DESCRIPTION
SMCXE278198SP	Crossing Arm, Air, Ce, Single Package, Defender
SMCXA128187SP	Crossing Arm Kit, Air Cross
SMC78600	Crossing Arm Service Kit
SMC068177K	Kit, Polyrod, 078114/28118, Stow Bracket
SMCXE278114SP	Crossing Arm Electric, Thomas, C2, Single Package, Defender
3564900C2	Crossing Arm Gate
SMC71207K	Control Module 7-Series Kit, Stop Arm
SMC078106SP	Crossing Arm Assembly, 7-Service, Electric, Base, Quick Disconnect
SOECVR12SAK	Lamp Kit, Bus Stop Arm, Light Set, Red, LED Retrofit
SMC68197	Crossing Arm Rod Assembly
SMC028114SP	Crossing Arm Assembly Base, Air, C2, Single Package
SMC000292K	Electrical Stop Arm Kit, Low Profile, Strobing-Reg, Air, LED
SMC002167SP	Hinge Outer Bearing Assembly, Cross/Stop Arm, Air
SMCSE27980ESP	Stop Arm, Electrical, High-Intensity, Defender
SMC7129	Cross/Stop Arm Control Module, 7-Series Retrofit 6-Series or Original 7-Series
SMC7178K	Cross/Stop Arm Motor, Wedge, Defender
SMCSE27500ESP	Cross/Stop Arm, Electric Engine, Defender
SMC78120	Crossing Arm, Electric
SMCSE27500SP	Stop Arm Electrical, Engine, 2-Light Incandescent, Defender
2607947C91	Stop Arm Clutch with Hardware Assembly
SMC78106	Crossing Arm Base, 7-Series, Quick Disconnect
SMC071291	Assembly, Polyrod, C2, Clamp Shell
SMCSE27980SP	Stop Arm, Electric, High-Intensity, Defender
SMC028158SP	Crossing Arm Hinge, Air, C2, Ptd
SMC000297K	Stop Arm Kit, Electric, Low-Profile, Strobe-Unreg LED



See It All with the Fleetrite® Dash Cam Product Line

See it all with the Fleetrite dash cam product line! Reduce false claims, exonerate drivers, use for coaching and safety tools, and observe the loading/unloading process. Record it all with the 64 GB SD Card dual view dash camera, which can record about 100 hours with medium quality at 5 frames per second.

fleetrite.com





SAFETY EQUIPMENT (CONT'D)

MIRRORS

PN	DESCRIPTION
4188589C91	Rear View, Pedestrian, RH, Black, Rear Mounted, Heated
4188594C91	Rear View, Pedestrian, LH, Chrome, Rear Mounted, Heated, TS AAT
4188588C91	Rear View, Pedestrian, LH, Black, Rear Mounted, Heated, AAT
4188595C91	Rear View, Pedestrian, RH, Chrome, Rear Mounted, Heated, TS, CB Radio
4188592C91	Rear View, Pedestrian, LH, Chrome, Rear Mounted, Heated, AAT
4188586C91	Rear View, Pedestrian, LH, Chrome, Rear Mounted, Heated, TS, CB Radio, AAT
ZR8960IH	Exterior Rear View, Open View, Head 8" x 6", Convex Glass, Heated, Motorized with IC Bus Wiring
3756628C91	Rear View, Premium, LH, Chrome, Rear Mounted, Heated, Ltd, AAT
4188587C91	Rear View, Pedestrian, RH, Chrome, Rear Mounted, Heated, TS, CB Radio
ZR8912IH	Exterior Rear View, 8" x 12", Motorized, Flat, Heated
4188584C91	Rear View, Pedestrian, RH, Chrome, Rear Mounted, Heated, CB Radio, AAT
4188581C91	Rear View, Pedestrian, RH, Black, Rear Mounted, Heated, CB Radio, AAT
4188582C91	Rear View, Pedestrian, LH, Black, Rear Mounted, Heated, TS, CB Radio, AAT
4188583C91	Rear View, Pedestrian, RH, Black, Rear Mounted, Heated, TS, CB Radio
ZR3365IH	Head, Mini Hawkeye, Heated
ZR7171OGH	Head, Motorized, Heated
ZR3365H	Head, Mini Hawk-Eye with Ball and Stud Mount, Heated
ZRM8960FXH	Head, 8" x 6" Hand Adjustable, Heated
ZR3365	Head, Mini Hawk-Eye with Ball and Stud Mount
ZR19ICL	Base, Tiger Grip Mounting, Left
ZR7171OG	Suspended, Motorized, 8" x 17" Dual, 7" x 9.5" Flat Glass, 7" x 6" Convex Glass
3757522C91	Rear View, Manual, Black, RH, Unheated, Lookdown
ZR2365IH	Hawk-Eye Head with Ball Stud Mount, Heated Internal Connector
2237181C93	Rear View, Open View Forward and Back, Heated, Motorized, Rosco
ZR2PPI21H008	System, RH, Heated, Cross View
ZR7151OGH	Head, LH, Suspended, Heated, Motorized
ZRASY2577	Mounting Bracket, Passenger
ZR7170GH	Motorized
ZR1030AM	Safety View, 10" x 30" AmTran



BUMPERS AND SUPPORT

PN	DESCRIPTION
2202919C2	End Cap, Bumper, Rear
307340000	Fender, Rubber
2204857C5	Bumper, Rear
2202918C2	End, Bumper, LH
3722104C2	Bumper, Rear, Right, 7"
4092805C1	Bumper, Rear, 4.5", Left Exhaust
420260001	End Cap, Rubber Rail
3814981C4	Bumper, Rear, Right, Exhaust
3722094C3	Bumper, Rear, Tow Hook, Painted Black
3722100C3	Bumper, Rear, Left, 7" Exhaust, Tow Hooks
3868573C1	Support, Bumper, Rear, LH
6122489C1	Fender Panel, Front
4092807C1	Bumper, Rear, Left, 4.5" Exhaust, Tow Hooks
6121527C2	Fender Panel, Front, Right
3868574C1	Bumper Support, Rear, RH
3815168C3	Bumper Support, Rear, RH



SAFETY EQUIPMENT (CONT'D)



DOORS

PN	DESCRIPTION
3878032C3	Panel, Door, Rear
2202960C2	Cover, Rear Door with Prop
2515576C92	Actuator Kit, Electronic Door
3779765C2	Latch, No Lock, Flush Trigger
3776933C5	Door, Entrance, Assembly Forward, Outward Opening, 27.25" Step, Black
2212169C1	Handle, L Type
2211999C3	Panel, Rear Outer, Left
2203818C4	Seal, Emergency Door, Rear, Rubber
2203819C3	Door, Control, Prop 16", Zinc Plated
3776935C5	Door, Entrance Assembly, Aft, Outward Opening, 27.25" Step, Black
2512465C91	Valve Kit, Dump, Entrance Door
3724540C5	Tube, Outward Opening Entrance Door, Aft Ce, 27.25" Step, Black
2229195C92	Door, Lug Box, Prime
452019002	Seal, Door Glass, Bus
2593969C1	Latch, Door, Front, RH, Manual
3732106C5	Tube Door Assembly, Outward Opening, Entrance Door, Aft Re, 27.25" Step, Black
3732101C4	Tube Assembly, Forward, Outward Opening, Entrance Door, Re, 25.75" Step, Black
2517707C91	Kit, Emergency Handle
3779766C1	Latch, Bus, Locking, 751 Key
3870031C1	Handle, Battery Tray
425860001	Handle, Door, Outer, Entrance, Plastic Handle, Pdc
437018001	Sleeve, Entrance Door, Top Hinge Pin
3724533C4	Casing Assembly, Entrance Door, Ce, 27.25" Step
453442001	Valve, Dump Assembly, Air Door
2209071C99	Door Assembly with Forward ADA Lift, Forward
3871541C1	Door, Wheelchair Lift, ADA, Forward



LIGHTING



LIGHTS, SWITCHES AND ELECTRIC

PN	DESCRIPTION
2222800C1	Solenoid, Battery Disconnect, Starter
2209522C1	Switch, Electric, Momentary Push Button
3867045C3	Switch, Door Control, 3-Position
3867044C3	Switch, Door Control, 2-Position
2207600C1	Switch, Toggle, 2-Position, Drive
2587219C1	Switch, Heater, 50" Cable
446283001	Panel, Fuse, 40 Circuit
454996001	Switch, 2-Position Toggle
441440001	Switch, Door Control, Passenger
442703001	Valve, Master Disconnect Solenoid 15V
2207601C1	Switch, Door Warning Lamp, 3-Position, Drive Plus
93105700	Switch, Micro Limit
448881001	Switch, Starter Interlock
3590744C1	Connector, Socket Relay
441142006	Switch, Rocker, Backlit, On/Off, Dpdt, V-Series, 20A 12V D/C
441441001	Switch, Door Control, 3-Position
441142003	Switch, Electric, Rocker, Backlit On/Off, Dpst, V-Series, 20A 12V D/C





LIGHTING (CONT'D)

LIGHTING	
PN	DESCRIPTION
2201570C8	Cap, Bow, with Marker, 4 Warning Lights
4154556C1	Light, Dual Face, RH, Amber/Red, LED
4154555C1	Light, Dual Face, LH, Amber/Red, LED
2204870C2	Hood, Warning Light, Black, Left Front, Right Rear
2204871C2	Hood, Warning Light, Black, Right Front, Left Rear
4078350C91	Light, Strobe, Passenger, Double Flash
433274001	Strobe Lamp Assembly, Low Profile, Double Flash Strobe
3784739C1	Warning Lamp Assembly, 7", Red, Sound Off, LED
3784738C1	Warning Lamp Assembly, 7", Amber, Sound Off, LED
3784743C1	Lamp, Backup, 7", White, Sound Off, LED
3784741C1	Lamp, Stop/Tail/Turn and License, Rear, 7", Red, Sound Off, LED
4096364C1	Light, 3", with Black Hood, White, LED
3784742C1	Lamp, Turn Signal Lamp, 7", Rear Turn, AM, LED
4067243C1	Lamp, Stop/Tail, 4", Red, with License Door
SOCVAUXLK80RR	Lamp, Warning, Aux Kit, Red
4067264C1	Lamp, Dome, White, LED
WEL1080110020	Lamp, Warning, FB, H3, Amber, 36 Package, Halogen
2509309C1	Lens, Marker, Replacement, Amber 1080, PDC
4078590C91	Strobe Lamp Assembly, 4.5", Double Flash, LED
4067246C1	Lamp, Marker, Armored, Amber, Slimline, LED
4067247C1	Lamp, Marker, Armored, Red, Slimline, LED
433246001	Lamp, Stop/Tail/Turn and License, Rear, Stop/Tail, 7", Red Lens with Black Base, PDC
4067240C1	Lamp, Marker, Armored, Red, LED
2230594C2	Light, Warning Amber, 7" Halogen
4067241C1	Lamp, Marker, Amber, Clearance, Armored, LED
4067237C1	Lamp, Marker, Amber, LED
3882988C1	Lamp, Emergency Warning, Amber, 7" Halogen
WEL1080110010	Lamp, Warning, FB, H3, Red, 36 Package, Halogen
3882989C1	Lamp, Emergency Warning, Red, 7" Halogen
2230592C1	Lamp, Stop/Tail/Turn and License, Rear, Stop/Tail, 7", Weld-On
3784740C1	Lamp, Front Turn Signal, 7", Front, Turn and Park, LED
4067242C2	Lamp, License Plate, Clear Lens, Sound Off
2230595C2	Light, Warning 7" Red, Halogen, Weld-On
433254001	Lamp, Turn Signal, Rear, 7", Park or Turn, Amber with Black Base
4067263C1	Lamp, Courtesy, Step Well, Clear Lens
4067238C1	Lamp, Marker, Red, LED
SOE756IEB0AFA	Warning Lamp, 7", FA, Amber
417090001	Lamp, Marker/Clearance, Red
2230576C1	Lamp, Marker, Double Bulb
SOE756IEB0RFA	Lamp, Warning, 7", Round, Red, 62 LEDs, 1.875" (4.8cm) Depth, Surface Mount on 6.25" (15.9cm) Centers
JW0554461	Headlight, Model 8910 Evolution 2, Heated, 5" x 7", 12-24V, DOT/ECE, RHT, High and Low Beam, Chrome Bezel, LED
WEL1010112010	Lamp, Stop/Tail, 7", Round, Black Base, SB, D/C 1157, Red, 48 Package

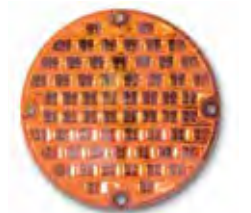

WINDOWS



WINDOWS AND GLASS	
PN	DESCRIPTION
4174631C1	Glass, Windshield Solex with Deflector
2201058C93	Tube Assembly, Outward Opening Door
2205542C2	Handle, Emergency Kick Out Window
2610206C92	Latch Kit, Window, Thumb, ZYTE
2209504C94	Storm Window, Driver, Aluminum
2201047C92	Tube, Outward Opening Entrance Door, Forward
452416005	Glass, Entrance Door Window, Outward Opening Aluminum, 73% LT



WINDOWS (CONT'D)



WINDOWS AND GLASS (CONT'D)

PN	DESCRIPTION
2233766C94	Sash Assembly, Window, Passenger, Split, Standard with 12" Opening, Aluminum, Tempered, 28% Tint
2202543C3	Windshield, Flat 3-Piece, Side
2234043C2	Extrusion, Aluminum Window Sliding Front Side Back
3821680C5	Glass, Windshield, Solex, Heated
2241658C1	Glass, Storm Window, Clear Laminated, As-2 Forward/Rear
2205455C3	Glass, Window, Laminated Split Sash
2201060C93	Tube Assembly, AFT Outward Opening Entrance Door
2202540C3	Windshield, Flat 3-Piece, Center
2233759C94	Sash Assembly, Window, Passenger, Split, Standard with 12" Opening, Aluminum, Laminated, 28% Tint
2241652C1	Glass, Door, Entrance, Outward Opening, Aluminum, Tempered, Split Pane
2241653C1	Glass, Door, Entrance, Outward Opening, Aluminum, Laminated, Split Pane
2201056C92	Tube Assembly, AFT Outward Opening Entrance Door
2233839C94	Sash Assembly, Window, Passenger, Split, 36" with 12" Opening, Aluminum, Tempered
2233815C92	Window, Passenger Kick Out Assembly, Standard with 12" Opening, Right, Aluminum, Tempered, 28% Tint
431339002	Windshield, Flat 4-Piece, Center with Shaded Band
2202438C1	Glass, Rear Quarter Window, 28% Tint
2212342C92	Extrusion, Window, Aluminum, Kick Out Handle Breaker Over Plate
3724807C2	Pivot Pin, Entrance Door, Bottom
2209523C1	Handle, Emergency Kick Out Window
2202197C1	Glass, Window, Drivers, 73% Tint, Laminated
2209530C1	Glass, Window, Tempered, Split Sash
2209483C1	Weatherstrip, Window Seal, Horizontal Driver's Window
2209760C1	Glass, Tempered Quarter
2241655C1	Glass, Storm Window, Stainless Steel, 27", Tempered Clear
2203482C2	Glass, Window, Rear, Bottom Door Laminated
2241657C1	Glass, Storm Window, Stainless Steel, 36", Tempered Clear
2233974C93	Storm Window, 27" with 9" Opening, Aluminum, Tempered Clear



ACCESSORIES



MISCELLANEOUS

PN	DESCRIPTION
3820201C1	Brake Valve, Pressure Protection, M22 x 3/8QC
90303602	Fabric, Rubber Coated 5"
3861372C1	Tube, Air Brake, TMS 7134 Type C 1/2 Black
427819001	Fadeout Assembly, Rub-Rail, Rub-Rail IS
2212001C4	Panel, Rear Outer, Right
424070003	Rub-Rail, Service Part 96"
3775944C94	Window, Passenger Sash Storm, 36" Aluminum Frame, Temperature Clear, 9" Opening
CSS203045	First-Aid Kit
2212812C1	Striping, Reflective, 3M Fluorescent
4085871C1	Cover, 18 Auxiliary Battery Box, Aluminum Outer Surface Finish
2227175C2	Tread, Step Bottom, Vinyl with Pebble Nosing Grey
2227166C2	Tread, Step, Top, Vinyl Pebble
2523520C1	Microphone, PA, Hand-Held
2212130C2	Product Graphic, Instruction
454696001	Antenna, Radio, Telescoping 96"
446883001	Pump, Washer Bottle, Windshield
2203537C1	Tread, Step, Top, Black
2508785C91	Microphone, PA, Hand-Held
2201622C3	Panel, Rear Inner, Left
FLTOCDVDASH	Dash Camera, Dual View, HD 1280 x 720 Resolution, Front 150°, In-Cab 150° Recording Angle, 64GB Max SD2 Data Storage, 4-Axis G-Sensor Accelerometer
2227170C2	Tread, Step, Bottom Vinyl Pebble
FLTROWIRELESS	Camera, Rear Observation, Visual Assist, Wireless, 7" Screen, 350' Transmitting Distance
6090760C1	Cylinder, Gas, Shock, Seat Flip



THERE'S NO BETTER TIME TO GO ELECTRIC



Introducing the all-new Electric CE Series from IC Bus

It is the first electric school bus to really get it right. We've worked hard to bring you the most advanced electric school bus in the industry, in the same safe, driver friendly package you're used to getting from us. Now is the best time to go electric.

Find the best way forward at icbus.com/electric



THE BEST WAY
FORWARD
FOR ELECTRIC

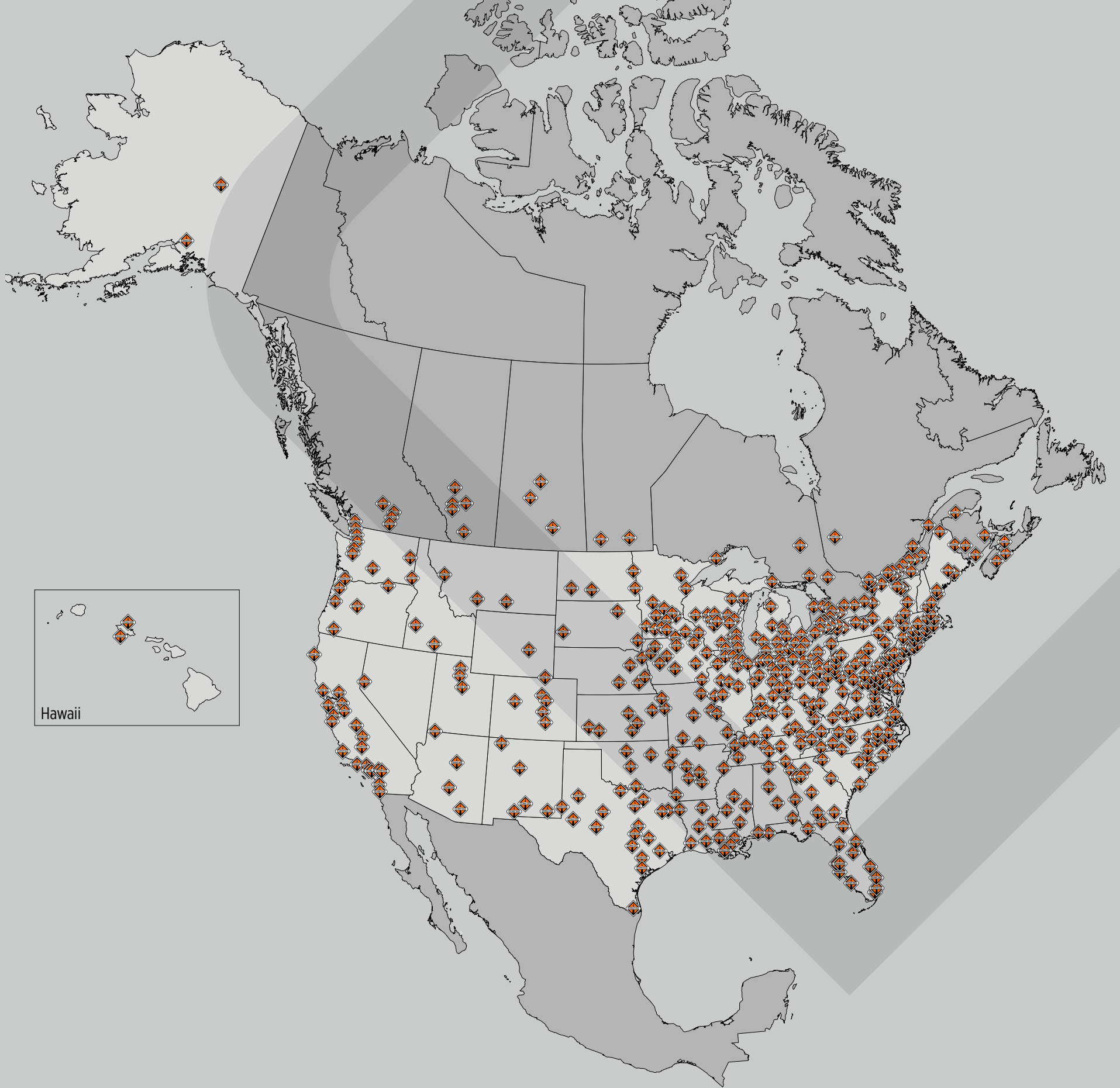

OUR GLOBAL PARTS NETWORK PROVIDES YOU WITH ONE OF THE MOST EXTENSIVE PARTS INVENTORIES IN THE TRUCKING INDUSTRY. WITH EIGHT PARTS DISTRIBUTION CENTERS IN THE UNITED STATES AND CANADA, WE HAVE ACCESS TO MORE THAN 1 MILLION UNIQUE PART NUMBERS, AS WELL AS SUPPORT FROM MORE THAN 700 DEALER LOCATIONS ACROSS NORTH AMERICA.

NAVISTAR



FLEETRITE

Navistar | 2701 Navistar Drive | Lisle, Illinois 60532, United States
1-800-448-7825 toll free | 331-332-5000 direct

All material in this literature is accurate as known at time of publication, but is subject to change without notice. International and other trademarks shown are registered trademarks of Navistar, Inc. or its affiliates. All marks are trademarks of their respective owners.

© 2023 Navistar, Inc. All rights reserved. PBC-23-3503